

DECEMBER 1, 1957

# electronics

engineering edition

MONTHLY PUBLICATION • PRICE ONE DOLLAR

*Dec 10*

TESTING  
SUPERPOWER  
KLYSTRON

In This Issue **INDEX TO ELECTRONICS ARTICLES** for 1957

OUR MILLIONTH FILTER SHIPPED THIS YEAR..

# FILTERS

## FOR EVERY APPLICATION



### TELEMETERING FILTERS

UTC manufactures a wide variety of band pass filters for multi-channel telemetering. Illustrated are a group of filters supplied for 400 cycle to 40 KC service. Miniaturized units have been made for many applications. For example a group of 4 cubic inch units which provide 50 channels between 4 KC and 100 KC.

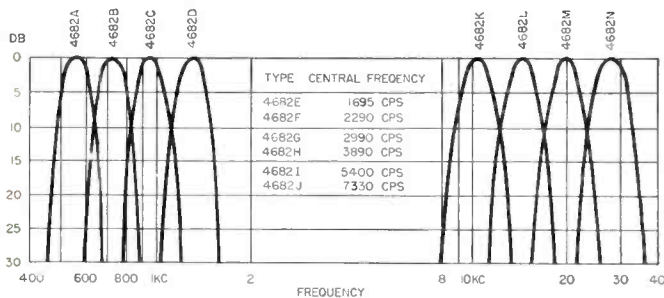

Dimensions:  
(4682A) 1 1/2 x 2 x 4"

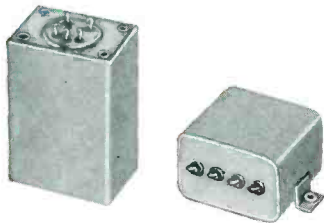

Dimensions:  
(3834) 1 1/4 x 1 3/4 x 2-3/16".  
(2000, 1) 1 1/4 x 1 3/4 x 1 5/8".

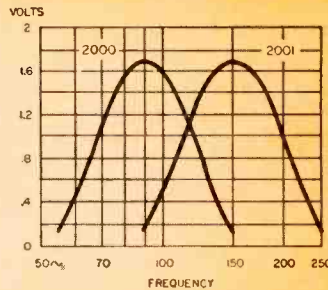
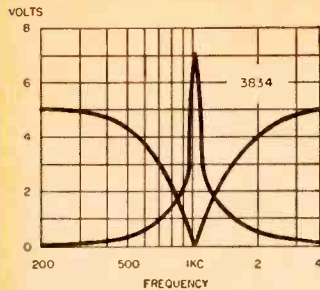

### AIRCRAFT FILTERS

UTC has produced the bulk of filters used in aircraft equipment for over a decade. The curve at the left is that of a miniaturized (1020 cycles) range filter providing high attenuation between voice and range frequencies.

Curves at the right are that of our miniaturized 90 and 150 cycle filters for glide path systems.

### CARRIER FILTERS

A wide variety of carrier filters are available for specific applications. This type of tone channel filter can be supplied in a varied range of band widths and attenuations. The curves shown are typical units.

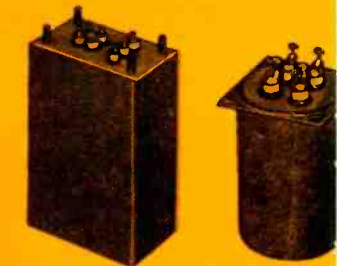
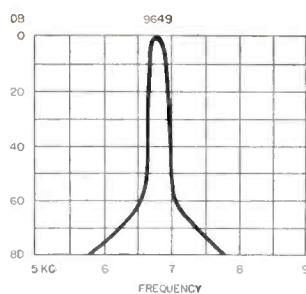
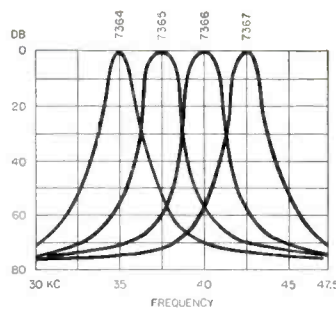

Dimensions:  
(7364 series) 1 5/8 x 1 5/8 x 2 1/4".  
(9649) 1 1/2 x 2 x 4".

### DISCRIMINATORS

These high Q discriminators provide exceptional amplification and linearity. Typical characteristics available are illustrated by the low and higher frequency curves shown.

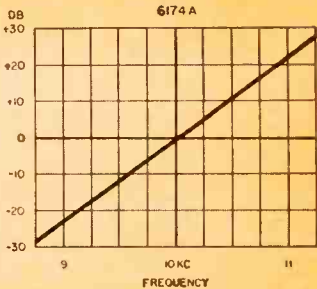
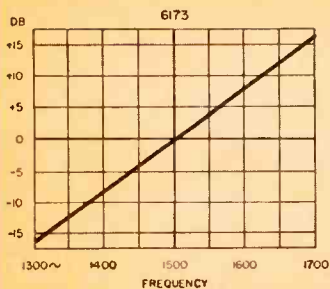

Dimensions:  
(6173) 1-1/16 x 1 3/8 x 3".  
(6174A) 1 x 1 1/4 x 2-1/4".

## UNITED TRANSFORMER CORP.

150 Varick Street, New York 13, N. Y.

EXPORT DIVISION: 13 EAST 40th STREET, NEW YORK 16, N. Y. CABLES: "ARLAB"  
PACIFIC MFG. DIVISION: 4008 W. JEFFERSON BLVD., LOS ANGELES 16, CALIF.

For full data on stock UTC transformers, reactors, filters, and high Q coils, write for Catalog A.

## ISSUE AT A GLANCE

H. W. MATEER, *Publisher*

W. W. MacDONALD, *Editor*

*Managing Editor*, John M. Carroll.

*Feature Editor*, John Markus.

*Associate Editors*: John M. Kinn, Jr., Frank Leary, Michael F. Tomaino, Howard K. Janis, Sylvester P. Carter, David A. Findlay, Haig A. Manoogian, Roland J. Charest, Donald C. Hoefler, William P. O'Brien, George Sideris, Edward DeJongh, John F. Mason, Barry Miller.

*Pacific Coast Editor* (Los Angeles) Harold C. Hood; *Midwestern Editor* (Chicago) Harold Harris; *New England Editor* (Boston) Thomas Maguire.

*Art Director*, Harry Phillips. Roy Thompsen.

*Production Editor*, John C. Wright, Jr. Bernice Duffy, Jean L. Matin.

*Editorial Assistants*: Gloria J. Filipone, Arlene Schilp, Noreen Hennessy, Phyllis A. Cronin, Barbara Habermann.

**JAMES GIRDWOOD**, *Advertising Sales Manager*. R. S. Quint, *Assistant Advertising Sales Manager and Buyer's Guide Manager*. Fred Stewart, *Promotion Manager*. Frank H. Ward, *Business Manager*. George E. Pomeroy, *Classified Manager*. Jean Heiges, *Research*. Wallace B. Blood, *Market Consultant*.

*New York*: Donald H. Miller, Henry M. Shaw, Martin J. Gallay, *Boston*: Wm. S. Hodgkinson. *Philadelphia*: James T. Hauptli. *Chicago*: Bruce Winner, Walter M. Luce. *Cleveland*: Warren H. Gardner. *San Francisco*: T. H. Carmody, R. C. Alcorn. *Los Angeles*: Carl W. Dysinger, Russell H. Antles. *Denver*: J. Patten. *Atlanta*: M. Miller. *Dallas*: Gordon L. Jones. *London*: Herbert Lagler.

**Testing Superpower Klystron.** Tube shown being lowered into test tank delivers up to 1,000,000 watts peak power r-f (See p 182)..... **COVER**

**How Transistors Operate Under Atomic Radiation.** Results of nuclear tests show that effects can be controlled by feedback..... p 125  
By Robert L. Riddle

**Transmitter Circuits for Suppressed-Carrier A-M.** Up-to-date transmitting techniques improve efficiency of a-m systems..... p 128  
By J. P. Costas and R. W. French

**Toroid Measures Spot Weld Current.** Voltage developed by coil around welding electrode is converted to steady-state meter reading..... p 132  
By Paton M. Zimmerman

**Dual-Purpose Circuitry Cuts Transceiver Size.** Reflex circuitry permits design of 1,750-channel transceiver using only 28 tubes..... p 134  
By Paul C. Wulfsberg and Charles H. Kirkpatrick

**Flat-Field Generator Speeds Color Tv Testing.** Provides composite color video signals of any hue and saturation as well as luminance signal..... p 139  
By Richard W. Cook

**Spot Scanner Counts Micron-Sized Particles.** Moving target indicator spots and counts particles such as bacteria colonies..... p 142  
By H. P. Mansberg, Y. Yamagami and C. Berkley

**Transistor Relays Have Low Idling Current.** Electronic relays require only a few microamperes..... p 147  
By D. W. R. McKinley

**Digital-Analog Converter Provides Storage.** Transistorized converter changes eight binary bits to 128 amplitude steps of a 400-cps sine wave..... p 148  
By H. N. Putschi, J. A. Raper and J. J. Suran

**Clamp-On Microammeter Measures A-C Current.** Small toroidal current transformer clamped about unknown current measures microamperes..... p 152  
By G. F. Montgomery and C. Stansbury

**Design and Manufacture of Practical Filter Circuits.** Deviation of actual filter performance from that calculated can be avoided..... p 154  
By Stanley Boyle

# CONTENTS (continued)

**Monovibrator Has Fast Recovery Time.** Monostable multivibrators in television sync generator use complementary transistors. . . . . p 158  
By A. I. Aronson and C. F. Chong

**Charts Simplify Passive L-C Filter Design.** Design of Butterworth and Tchebycheff filters with prescribed steady-state insertion loss is simplified. . . . . p 160  
By Donald R. J. White

**Puncher Transcribes Computer Output.** Transistor circuit assemblies provide logical and driving operations for card puncher. . . . . p 164  
By J. E. Palmer and C. H. Propster, Jr.

**Compact Supplies Have Wide-Range Regulation.** Solid-state rectifiers and high current regulator tubes eliminate power transformer. . . . . p 168  
By W. F. Schreiber

**Graphic Construction Finds Clear I-F.** Plotting crystal frequencies against channel frequencies prevents spurious responses. . . . . p 170  
By William Vernon Hargreaves, Jr.

**Servo Analysis Charts.** Graphical conversion data for open-to-closed or closed-to-open loop operation. . . . . p 173  
By Erwin Bieser and Samuel Adler

**FIGURES OF THE MONTH** . . . . . p 6

**INDUSTRY REPORT** . . . . . p 7

**ANNUAL INDEX 1957** . . . . . p 112A

**ELECTIONS AT WORK** . . . . . p 178

**ELECTRONS AT WORK** . . . . . p 178

Sputnik's Beep . . . . . 178	Solar Powered Electric Fence. . . . . 188
Conductor for Printed Circuits. . . . . 178	By G. W. Isaacs
By L. N. Merson	Meter Shows Current Drift. . . . . 192
Altitude Simulator . . . . . 180	By David T. Geiser
The Front Cover . . . . . 182	VHF Rheostat . . . . . 196
Extended Output Flip Flop. . . . . 182	By W. B. Wrigley and
By R. W. Hofheimer	T. R. Scott, Jr.
Infrared Camera . . . . . 184	Sweep Testing Thyratrons. . . . . 206
Phototubes Count Buses. . . . . 188	By J. G. Weissman

**PRODUCTION TECHNIQUES** . . . . . p 214

Bags Protect Printed Circuits . . . . . 214	Hot Air Jet Tests Parts . . . . . 226
Lab Benches Have Outlets . . . . . 214	By Lloyd Ware and John Fallon
Ultrasonic Welding of Foil. . . . . 216	Splicing Shielded Cable. . . . . 232
Design of the Month: Relay. . . . . 216	Double-Deck Parts Cart. . . . . 238
Soldering Aluminum Without Flux. 222	Anodizing Insulates Aluminum. . . . . 246
	Epoxy Adhesive Kit. . . . . 240

**NEW PRODUCTS** . . . . . p 248

**LITERATURE** . . . . . p 313

**PLANTS AND PEOPLE** . . . . . p 316

**NEW BOOKS** . . . . . p 334

**THUMBNAIL REVIEWS** . . . . . p 337

**LETTERS** . . . . . p 338

**INDEX TO ADVERTISERS** . . . . . p 363

# electronics

December 1, 1957 Vol. 30, No. 12

Published three times a month with an additional issue in June, by McGraw-Hill Publishing Company, Inc., James H. McGraw (1860-1948) Founder.

Executive, Editorial, Circulation and Advertising Offices: McGraw-Hill Building, 330 W. 42 St., New York 36, N. Y.

Longacre-4-3000. Publication Office 99-129 North Broadway, Albany 1, N. Y. See panel below for directions regarding subscription on change of address. Donald C. McGraw, President; Joseph A. Gerardi, Executive Vice President; L. Keith Goodrich, Vice President and Treasurer; John J. Cooke, Secretary; Nelson Bond, Executive Vice President, Publications Division; Ralph B. Smith, Vice President and Editorial Director; Joseph H. Allen, Vice President and Director of Advertising Sales; A. R. Venezian, Vice President and Circulation Coordinator.

Single copies \$1.00 for Engineering Edition and 50¢ for Business Edition in United States and possessions, and Canada; \$2.00 and \$1.00 for all other foreign countries. Buyers' Guide \$3.00. Subscription rates—United States and possession, \$6.00 a year; \$9.00 for two years. Canada, \$10.00 a year, \$16 for two years. All other countries \$20.00 a year, \$30.00 for two years. Three year rates accepted on renewals only, are double the one-year rate. Second class mail privileges authorized at Albany, N. Y. Printed in U.S.A. Copyright 1957 by McGraw-Hill Publishing Co., Inc.—All Rights Reserved. Title registered in U. S. Patent Office. BRANCH OFFICES: 520 North Michigan Avenue, Chicago 11; 68 Post Street, San Francisco 4; McGraw-Hill House, London E. C. 4; National Press Bldg., Washington, D. C. 4; Architects Bldg., 17th & Sansom Sts., Philadelphia 3; 1111 Henry W. Oliver Bldg., Pittsburgh 22; 1510 Hanna Bldg., Cleveland 15; 856 Penobscot Bldg., Detroit 26; 3615 Olive St., St. Louis 8; 350 Park Square Bldg., Boston 16; 1321 Rhodes Haverty Bldg., Atlanta 3; 1125 West Sixth St., Los Angeles 17; 1740 Broadway, Denver 2. ELECTRONICS is indexed regularly in The Engineering Index.

Subscriptions: Address correspondence to Subscription Manager, Electronics, 330 W. 42nd St., New York 36, N. Y. Allow one month for changes of address, stating old as well as new address. Subscriptions are solicited only from persons engaged in theory, research, design, production, maintenance and use of electronic and industrial control components, parts and products. Position and company connection must be indicated on subscription orders.

Postmaster: please send form 3579 to Electronics, 330 W. 42 St., New York 36, N. Y.



Member ABC and ABP

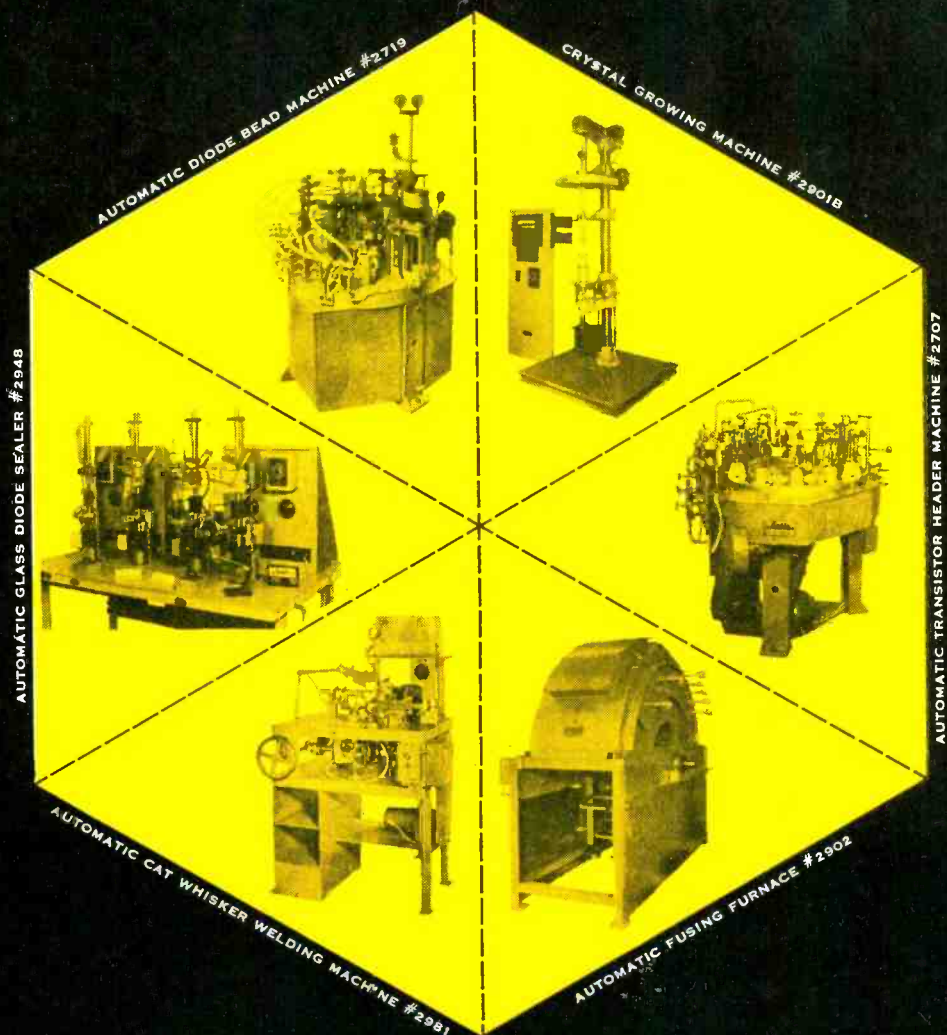

**semiconductor manufacturers!**

# **KÄHLE** automatic machines offer six important features

## **FEATURE NUMBER ONE**

Higher production speeds than ever before on all types of automatic semiconductor machinery increase profits, lower costs.

## **FEATURE NUMBER TWO**

Kahle automated machines shape diodes of highest quality — eliminate cumbersome non-productive hand assembly with greater precision.

## **FEATURE NUMBER THREE**

Kahle offers a complete line of semiconductor machinery for all the operations between crystal growing and final sealing.

## **FEATURE NUMBER FOUR**

When you specify Kahle, you specify 25 years of electronic production machinery experience.

## **FEATURE NUMBER FIVE**

Each Kahle machine is specifically designed to solve your individual production problem. No bottlenecks as downtime is kept to a minimum.

## **FEATURE NUMBER SIX**

No risk is involved when you specify Kahle because machines do not leave Kahle's factory until they operate to your complete satisfaction. Write today for Kahle catalog sheets . . . please describe your requirements.

# **KÄHLE** ENGINEERING COMPANY

GENERAL OFFICES:  
1310 SEVENTH STREET  
NORTH BERGEN, N. J.

PLANTS:  
SEVENTH STREET, NORTH BERGEN, N. J.  
HUDSON AVE., UNION CITY, N. J.

DESIGNERS AND BUILDERS OF MACHINERY FOR THE PRODUCTION OF ELECTRONIC TUBES, SEMI-CONDUCTORS, LAMPS AND RELATED DEVICES



## Get Your Own B-NOBATRON!

**Multi-purpose B-Power Source Available in Five Models, Ranging from 300 to 1000 VDC Tops; Low Ripple, Accurate Regulation; Provide Filament and Bias Current in Addition to High Voltage Output.**

Here's the economical and lasting answer to B-Power supply needs for nearly every laboratory, and many industrial operations. Nobatrons are built to last, and serve without maintenance. Damage to the Nobatron and its load is prevented by input and output fuses. Five models offer ranges of: 0-300 VDC, 0-325 VDC, 0-500 VDC, 0-600 VDC, and 200-1000 VDC. All but the largest model deliver 6.3 volts for filament supply and all but the 300-B and 1000-BB offer 0-150 volt regulated bias.

Regulation accuracy is within a maximum tolerance of 0.5%\*, and ripple is held to five millivolts RMS or below (except for 20 mv. maximum on the 200-1000 VDC model). Input range is 105 to 125 VAC, with frequency of 50, 60, or 400 cycles. B-Nobatrons may be used in either cabinet or rack mountings, and are a handsome contribution to their quarters. Your local Sorensen representative will be glad to tell you all about these B-Nobatrons. Write directly for technical data, to

**SORENSEN & COMPANY, INC.** Richards Avenue, South Norwalk, Connecticut

*\*Only 0.15% maximum variation on the 0-300; and 0.25% on the 0-600 models.*

### SPECIFICATIONS

Model	300B*	325BB	500BB	600B	1000BB
Output Voltage VDC	0-300	0-325	0-500	0-600	200-1000
Output Current Ma	0-150	0-125	0-300	0-500	0-500
Regulation Accuracy	±0.15%**	±0.5%	±0.5%	±0.25%	±0.5%
Ripple (MV-RMS)	5 max.	5 max.	5 max.	3 max.	20 max.
Bias Supply (VDC)	—	0-150	0-150	0-150	—
Max. Bias Circ. Imp. (Ohms)	—	25000	25000	50000	—
Max. Int. Imp. (Ohms)	2.0	2.0	2.0	2.0	2.0
AC Voltage (CT Unreg.)	—	6.3/10 amps	6.3/10 amps	6.3/15 amps	—
Filament Voltages (Unreg.)	6.3 at 5 amps, series or parallel (two outputs)	—	—	—	—

\*may be connected positive or negative, in series or parallel  
\*\*or ±0.3 volts, whichever is greater

**CONTROLLED POWER FOR  
RESEARCH AND INDUSTRY**

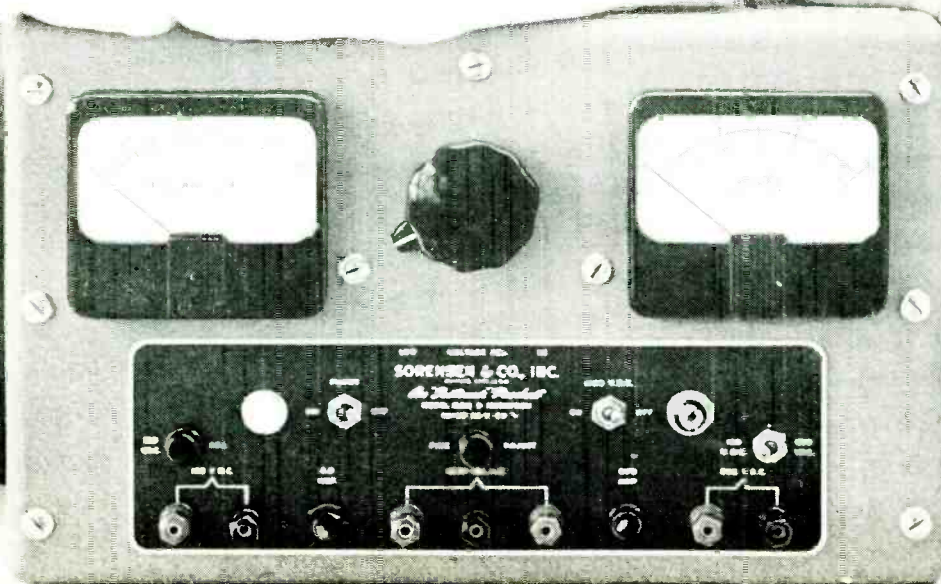

# MARCONI'S SPEED SSB CHECKS

## HF SPECTRUM ANALYZER TYPE OA 1094

The Marconi OA 1094 Analyzer gives an immediate panoramic display of the frequency spectra of signals in the band 3 to 30 MC. It brings speed and convenience to the alignment of SSB communication transmitters and drives. Intermodulation distortion, hum level and carrier compression, the bandwidth of FSK and on/off keyed signals—these can all be seen at a glance and evaluated directly against the CRT graticule. A crystal-controlled first local oscillator insures a drift-free display at sweep widths as low as 100 cps. Highly-selective IF crystal filters provide 60 db discrimination between components as little as 60 cps apart.

#### ABRIDGED SPECIFICATION

**Frequency Range:** 3 to 30 MC in 9 bands with separate fixed drive-frequency input.

**Sweep Width:** Continuously variable up to 30 KC.

**Sweep Duration:** 0.1 to 30 sec in 6 steps.

**Amplitude Measurement Range:** 0 to -30 db and -30 to -60 db relative to reference signal.

**IF Bandwidths:** 6, 30, and 150 cps.

**CRT:** 6-inch diameter with long-persistence phosphor.

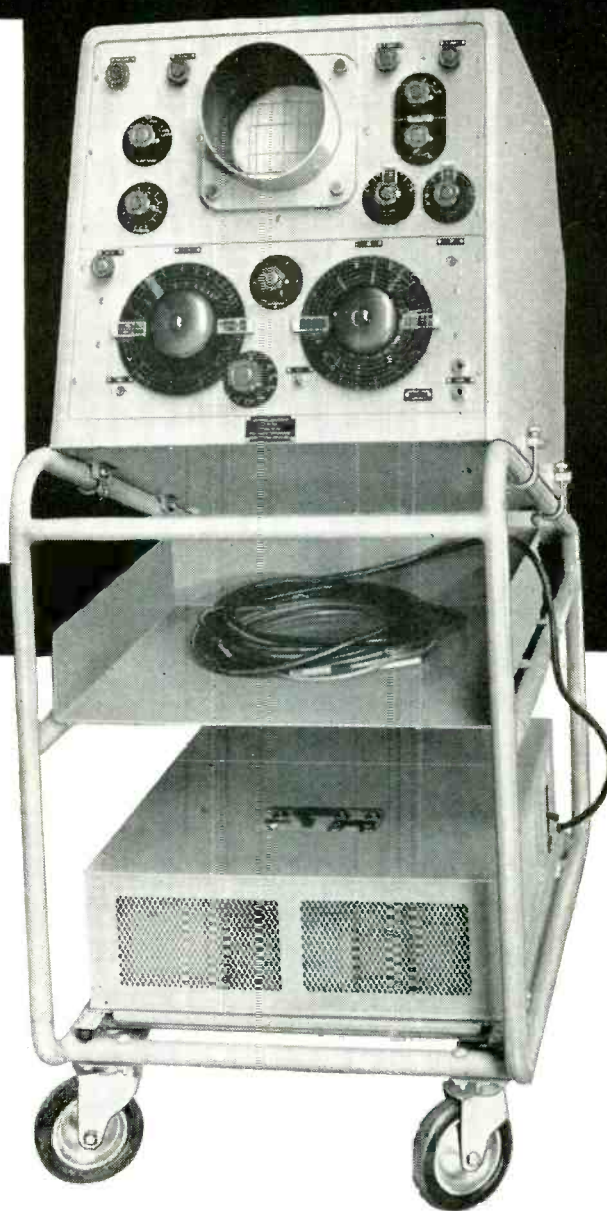

*Designed and developed by communication engineers of the British General Post Office for use at their HF point-to-point transmitter stations, the OA 1094 is manufactured by Marconi Instruments under GPO authority.*

**MARCONI  
INSTRUMENTS**

*Marconi - since 1897*

44 NEW STREET · NEW YORK 4

CANADIAN MARCONI COMPANY,  
6035, COTE DE LIESSE,  
MONTREAL 9, CANADA.

HEAD OFFICE: MARCONI INSTRUMENTS LTD · ST. ALBANS · HERTS · ENGLAND

TC 85

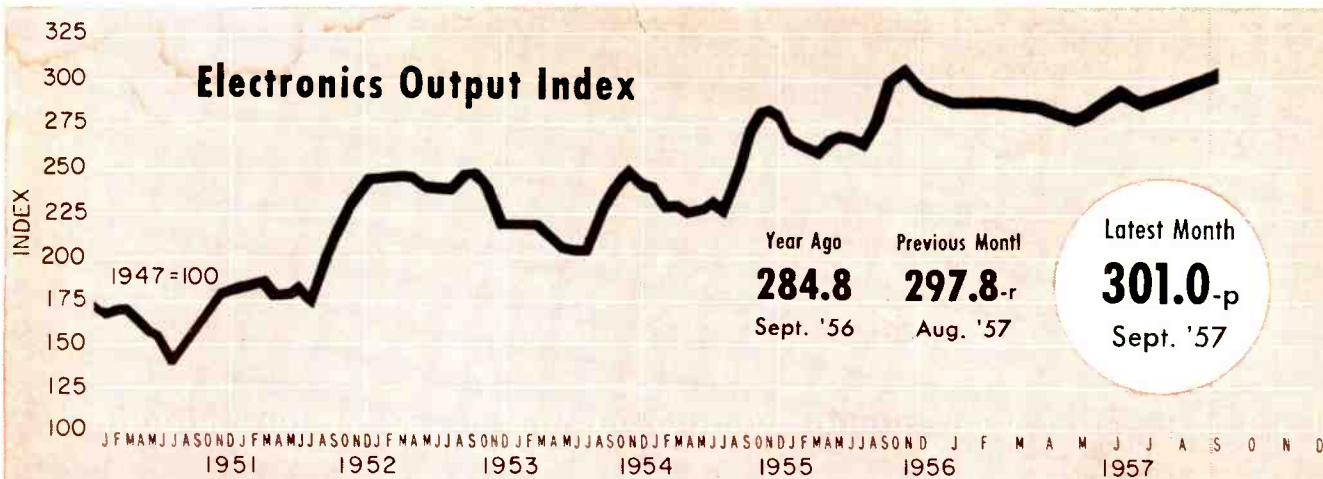

## FIGURES OF THE MONTH

	Latest Month	Previous Month	Year Ago		Latest Month	Previous Month	Year Ago
<b>RECEIVER PRODUCTION</b>				<b>BROADCAST STATIONS</b>			
(Source: RETMA)				(Source: FCC)			
Television sets, total	832,631	673,734	894,211	TV stations on air	528	522	507
With UHF	87,040	88,615	96,785	TV stations CPs—not on air	133	132	113
Color sets	nr	nr	nr	TV stations—new requests	77	78	49
Radio sets, total	1,610,748	965,724	1,319,189	A-M stations on air	3,113	3,095	2,939
Auto sets	446,419	301,971	349,790	A-M stations CPs—not on air	148	155	112
				A-M stations—new requests	340	340	268
				F-M stations on air	532	531	525
				F-M stations CPs—not on air	30	31	20
				F-M stations—new requests	37	25	9

### RECEIVER SALES

	Sept. '57	Aug. '57	Sept. '56
Television sets, units	705,247	510,097	763,908
Radio sets (except auto)	893,366	710,553	756,345

### RECEIVING TUBE SALES

	Sept. '57	Aug. '57	Sept. '56
Receiv. tubes, total units	44,382,000	43,029,000	44,432,000
Receiv. tubes, value	\$35,545,000	\$34,886,000	\$35,093,000
Picture tubes, total units	1,071,662	930,296	1,267,045
Picture tubes, value	\$20,819,036	\$17,984,185	\$21,709,064

### COMMUNICATION AUTHORIZATIONS

	Aug. '57	July '57	Aug. '56
Aeronautical	54,138	51,463	50,641
Marine	65,226	64,067	58,432
Police, fire, etc.	23,710	23,550	21,153
Industrial	36,837	36,261	31,146
Land transportation	9,708	9,652	9,141
Amateur	165,860	163,994	150,565
Citizens radio	29,892	28,864	19,997
Disaster	347	347	330
Experimental	806	797	730
Common carrier	2,921	2,856	2,412

### EMPLOYMENT AND PAYROLLS

	Aug. '57	July '57	Aug. '56
Prod. workers, comm. equip.	409,800-p	393,700-r	392,300
Av. wkly. earnings, comm.	\$77.81 -p	\$75.85 -r	\$75.76
Av. wkly. earnings, radio	\$75.81 -p	\$75.24 -r	\$73.75
Av. wkly. hours, comm.	39.9 -p	39.1 -r	40.3
Av. wkly. hours, radio	39.9 -p	39.6 -r	40.3

### SEMICONDUCTOR SALES ESTIMATES

	Sept. '57	Aug. '57	Sept. '56
Transistors, Units	3,231,000	2,709,000	1,115,000

### STOCK PRICE AVERAGES

	Sept. '57	Aug. '57	Sept. '56
Radio-tv & electronics	46.57	47.28	55.44
Radio broadcasters	58.39	60.63	69.83

p—provisional      r—revised      nr—not reported

### INDUSTRIAL TUBE SALES

	Quarterly Figures		
	Latest Quarter	Previous Quarter	Year Ago
(Source: NEMA)	2nd '57	1st '57	2nd '56
Vacuum	\$10,191,621	\$11,224,707	\$7,680,250
Gas or vapor	\$2,758,630	\$3,332,357	\$2,983,488
Magnetrons and velocity modulation tubes	\$17,177,922	\$15,359,108	\$16,254,025
Gaps and T/R boxes	\$1,589,670	\$1,409,463	\$1,238,469

### MILITARY PROCUREMENT

	1st '57	4th '56	1st '56
Army	\$69,381,000	\$56,185,000	\$40,490,000
Navy	\$21,426,000	\$34,210,000	\$28,700,000
Air Force	\$159,829,000	\$145,962,000	\$124,828,000
Total—Electronics	\$250,636,000	\$236,357,000	\$194,018,000

## FIGURES OF THE YEAR

Television set production	4,589,164	5,259,271	-12.7	7,357,029
Radio set production	10,376,354	9,535,896	+ 8.8	13,981,800
Television set sales	4,452,081	4,603,626	- 3.2	6,804,756
Radio set sales (except auto)	5,840,372	5,405,052	+ 8.0	8,332,077
Receiving tube sales	341,663,000	347,436,000	- 1.7	464,186,000
Cathode-ray tube sales	7,308,552	8,087,352	- 9.6	10,987,021

### TOTALS FOR FIRST NINE MONTHS

	1957	1956	Percent Change	1956 Total
Television set production	4,589,164	5,259,271	-12.7	7,357,029
Radio set production	10,376,354	9,535,896	+ 8.8	13,981,800
Television set sales	4,452,081	4,603,626	- 3.2	6,804,756
Radio set sales (except auto)	5,840,372	5,405,052	+ 8.0	8,332,077
Receiving tube sales	341,663,000	347,436,000	- 1.7	464,186,000
Cathode-ray tube sales	7,308,552	8,087,352	- 9.6	10,987,021



# INDUSTRY REPORT

electronics—December 1 • 1957

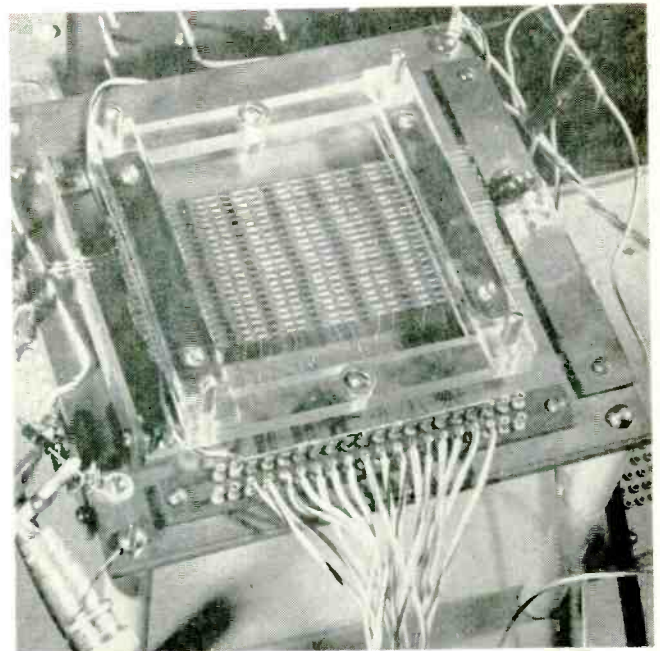

**CHECKING** memory characteristics (left) and setting up an experimental magnetic memory array (right) are key steps in trying to prove . . .

## Crossed Wires: New Concept In Memory Devices

Foresee systems simpler to fabricate and more economical to manufacture

WORD OF a new concept in memory devices is spreading quickly throughout industry this week.

It is claimed the concept will make possible memory systems which are simpler to fabricate and more economical to make than existing systems.

The concept has been named the "Twistor". It has emerged from exploratory work by A. H. Bobeck at Bell Telephone Laboratories.

► **Applications**—The firm claims

such devices may have extensive applications in computers and electronic switching systems where rapid-access, high capacity memories are necessary.

The concept, says Bell, opens the way for the construction of magnetic memory arrays by merely interweaving horizontal copper wires and vertical magnetic wires—much as window screen is woven. Such a device would be similar in appearance to a ferrite core array, but without the cores, and would operate in much the same way as a core array.

A characteristic of wire made

of magnetic material gives the "Twistor" name to the new concept. Torsion applied to such a wire shifts the preferred direction of magnetization from a longitudinal to a helical path.

► **Possibilities**—Thus, the coincidence of a circular and a longitudinal magnetic field can then be used to insert information into this wire in the form of a polarized helical magnetization, and the magnetic wire itself can be used as a sensing means.

Investigations are now underway to determine optimum size and composition for the magnetic wires. It appears that a conductor

plated with magnetic material may have some advantages.

Diameters as small as one-thousandth of an inch appear to be feasible. At least 10 bits per inch may be stored on such a wire without adverse interaction.

► **Advantages** — In conventional magnetic core memory devices, conductors must be threaded through the cores to make up a suitable matrix. When a ferrite sheet is employed, either a threading or a plating operation is necessary to suitably locate the conductors.

However, with the "Twistor," says the firm, the ferrite material is completely eliminated and no threading or plating is necessary. Speed of operation and output of the "Twistor" are said to be comparable to ferrite memory systems.

Present indications are that the drive circuits for a "Twistor" array can be readily transistorized. Thus, the company claims, a memory system using the new concept will retain all of the advantages of ferrite core or sheet systems, and will be much simpler and more economical to manufacture.

## Military Uses More Civil Radar

Armed forces constitute expanding market for slightly modified gear

MORE commercial radar equipment is finding its way, with only slight modifications, into military applications these days.

Latest move of this kind involves Raytheon's small-boat, search radar, "Mariners Pathfinder 1,500," that will be installed on 133 Navy light personnel and vehicle surface craft (LCPL's and LCV's). The gear is designated AN/SPS-35. First deliveries are scheduled to begin this month. Total contract amounts to \$548,700.

► **Refinements** — First marketed commercially in 1955, the civilian Pathfinder is now aboard more than 1,000 smaller vessels.

The military version has two added refinements. A variable range marker and counter has been added which tells the user the target's exact distance. On the commercial model, the distance must be visually estimated between range rings. Possible range scales on the 10-in scope are 1, 2, 4, 8, 16 and 32 miles. Second addition is a true north indicator. Commercial model offers only relative bearing.

Navy plans to install the radar in only a percentage of its landing craft. During an invasion



Modified civilian search radar will provide Navy with low-cost all-weather guidance for small amphibious craft

landing, radar-equipped squad leaders can check not only their own positions, but can monitor the other craft as well.

► **Performance** — The equipment can detect an 18-in buoy as close as 50 yards. Land can be picked up as far away as 32 miles. Power requirements are low, using only the craft's regular batteries. To make replacement parts more available, common radio and tv tubes have been used.

Two other civilian radars now adapted for military use are RCA's 50-mile-range weather avoidance radar now available to USAF planes as the AN/APS-69 (ELECTRONICS, Sept. 20, 1957), and GPL's RADAN doppler navigation set, converted for USAF use and designated the AN/APN-102 (ELECTRONICS, Oct. 10, 1957).

## Calls Components Key To Future Air Force

But officer says new designs, materials, techniques—not refinements—are top needs

NEW MATERIALS, new techniques and new design concepts are today's ranking needs in the field of high temperature electronic components.

It's now time to stop placing emphasis on refinements of existing technology. Such refinements will not be enough to meet future needs.

These views were expressed recently by Col. J. S. Lambert, Air Research and Development Center. He spoke at the third annual meeting of IRE's Professional Group on Electronic Devices in Washington, D. C.

"The key to the Air Force's future rests in the development of high temperature electronic components," Lambert said.

► **Needs**—But before it is possible to design the components needed, it is necessary to get more information on electrical and physical properties of materials now in use; then follow with new and better materials.

Lambert also thinks means of cooling, shielding and protecting electronic equipment from the more severe environmental conditions are only stop gaps. They will be followed by a number of high temperature components giving more flexibility in equipment design. He says there must be components available which are intrinsic to severe environments.

The highest temperature that commercial components in general are being designed to work in is 85 C. Air Force is attempting to hit 125 C; non-conventional applications may reach up to 500 C.

► **Applications**—For high temperature applications, AF reports that high temperature transistors will not be used. There will be electronic tubes, even though indium phosphide and gallium arsenide

(Continued on page 10)

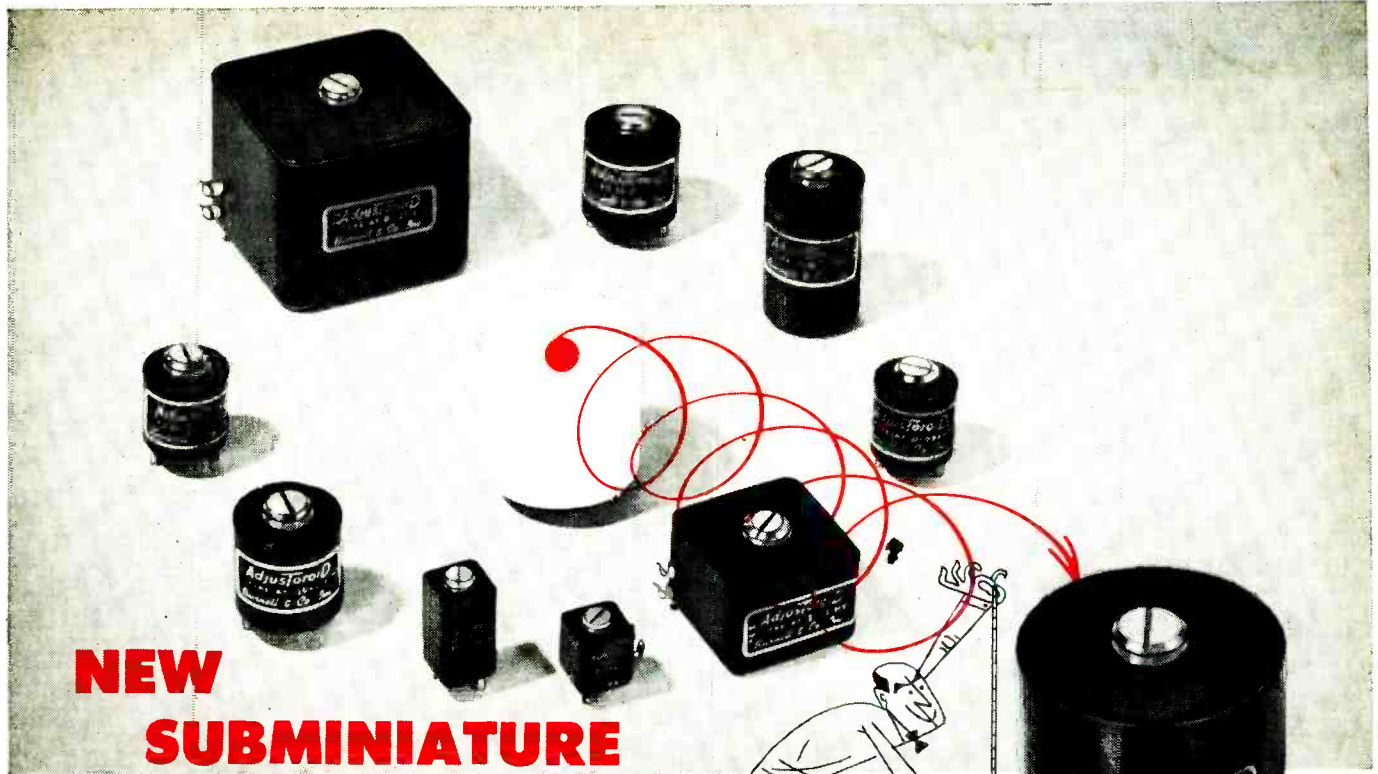

**NEW**  
**SUBMINIATURE**  
**BURNELL**  
**ADJUSTOROID\***  
**HANDLE BIG JOBS**

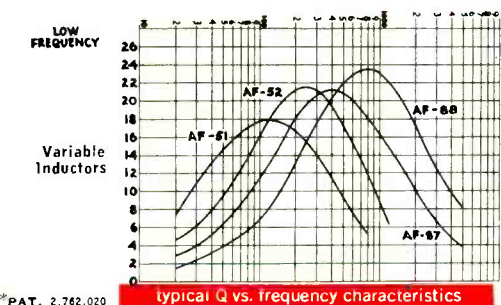
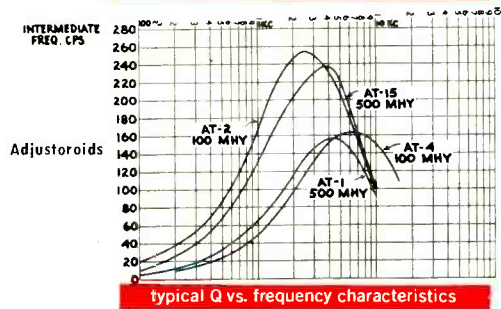
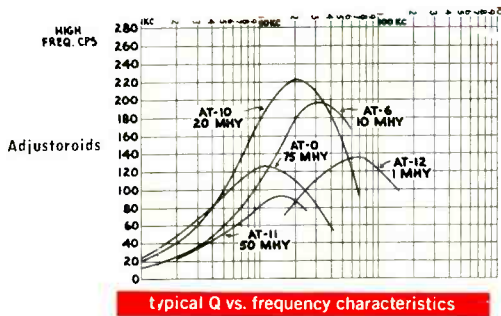

The new subminiature Burnell Adjustoroids® utilizing an ingenious patented method of magnetic biasing cover a wide range of frequencies, occupy less space and are available at low cost.

New Burnell Adjustoroids possess in addition to all the outstanding characteristics of non-adjustable toroids:

Precise continuous adjustment of inductance over a 10% range.  
 No need for external control current.  
 Hermetic sealing to meet Government MIL E # 15305-A specifications.

If your adjustoroid needs can't be met from our stock catalogue, we'll be glad to manufacture to your specifications.

	Length/ Dia.	Width	Hgt.	Wt.	Useful Freq. Range	Max Q	Max L in hys
AT-0	1 1/16		1"	2 oz	1 kc to 20 kc	10 kc	3 hys
AT-1	1 9/16	1 3/4	1 1/4"	7 1/4 oz	2 kc to 10 kc	4 kc	15 hys
AT-2	2 3/4	2 3/4	2 1/4"	24 oz	Below 2.5 kc	2.5 kc	125 hys
AT-4	1 13/16		1 1/4"	4 oz	1 kc to 16 kc	6 kc	15 hys
AT-6	1 1/16		1"	2 oz	10 kc to 100 kc	30 kc	.75 hys
AT-10	1 13/16		1 1/4"	4 oz	3 kc to 50 kc	20 kc	.75 hys
AT-11	4 5/16	4 5/16	3/4"	.83 oz	2 kc to 25 kc	15 kc	5 hys
AT-12	4 5/16	4 5/16	3/4"	.83 oz	15 kc to 150 kc	60 kc	.5 hys
AT-15	1 33/32		1 7/8"	14 oz	Below 5 kc	4 kc	125 hys
AF-51	1 13/16		2"	5 oz	30 cps to 500 cps	120 cps	1000 hys
AF-52	1 13/16		2"	5 oz	50 cps to 1 kc	250 cps	1000 hys
AF-87	4 5/16	4 5/16	1 1/4"	1.7 oz	90 cps to 2 kc	400 cps	80 hys
AF-88	4 5/16	4 5/16	1 1/4"	1.7 oz	1.6 kc to 4 kc	800 cps	42 hys

*Burnell & Co., Inc.*  
 first in toroids, filters and related networks

**EASTERN DIVISION**  
 10 PELHAM PARKWAY  
 PELHAM MANOR, N. Y.  
 PELHAM 8-5000  
 TELETYPE: PELHAM 3633



**PACIFIC DIVISION**  
 720 MISSION STREET  
 SOUTH PASADENA, CALIFORNIA  
 RYAN 1-2841  
 TELETYPE: PASACAL 7578

DEPT. E-127

are among those showing great promise as possible materials for high temperature semiconductor devices.

Meantime, the ceramic tube is being adopted. In cases of the smaller ceramic tubes, the AF thinks that operation at 300 C could be maintained for reasonably long periods. Printed circuits probably will be used to assemble components for high temperature applications.

## Custom Tubes Produce Unexpected Markets

ELECTRONICS survey shows today's unique tube may be common item of tomorrow

INCREASING demands of an expanding electronics industry today generate a need for new special-characteristic vacuum tubes. Yet tubes developed for a single highly-specific purpose often find or help create many other applications. A spot check of tube manufacturers reveals that many of today's custom-made tubes may be the common shelf-replacements of tomorrow.

► **Forerunner** — Made-to-order to meet given specifications or to satisfy specific circuit requirements, the custom tube occasionally sires a new tube line. A few years ago Tung-Sol Electric was asked to develop a tube to operate off the 12-volt supply in a hybrid automotive radio. In response they designed and produced 1,000 12K5 tetrode class A amplifiers. By 1956 sales of the 12K5 blossomed beyond 1,000,000. Concurrently, Tung-Sol came up with a whole line of hybrid radio tubes whose sales last year reached 4,000,000. Of the 21 hybrid radio tubes currently registered with EIA, 12 were Tung-Sol designed.

► **Obstacles** — Cost of retooling, limited volumes, prospective saleability and future applications are some factors the tube manufac-

turer considers before accepting custom tube orders. But no single consideration is decisive.

While concerned with the size of initial order and necessary retooling, Sylvania reports it may undertake custom-tube work as an obligation to a good customer. Tung-Sol is not too concerned about quantity as developmental costs are usually absorbed in the first order.

In developing custom tubes, United Electronic in Newark prefers small orders, perhaps not exceeding ten tubes. With this small quantity, the firm can easily make

modifications and improvements at the customer's request after observing initial performance. Quantity production and EIA registration may follow when marketing outlook is promising.

Among the 40 tubes specially developed by United, only a few of which are EIA registered, are high-vacuum rectifiers, clipper diodes, and special triodes designed for radar applications.

► **Stages**—The transient nature of the custom tube designation is illustrated by the varying stages of

(Continued on page 12)

## Business Briefs

► **Harris-Intertype** purchases all stock of **Gates Radio** of Quincy, Ill., for cash. Amount of purchase was not disclosed. Gates produces commercial broadcasting equipment. Harris makes equipment and supplies for the printing industry. Acquisition of Gates provides an operating basis for broader development in electronics, comments the purchaser.

► **Electronic Specialty Co.** of Los Angeles acquires the **Cado** division of **Electromation, Inc.**, Santa Monica, Calif. Cash plus stock were given in payment, but amounts were not revealed. Cado's patented lobing switch and subminiature coaxial switch were prime attractions for the purchaser. The purchased division will become part of **Electronic Specialty's Radiating Systems Division**.

► **Payson & Trask**, New York venture capital firm, makes investment in **Photomechanisms, Inc.**, Huntington, N. Y. Photomechanisms specializes in photographic instrumentation. Its subsidiary, **F. B. MacLaren and Co.**, designs and manufactures electronics for servomechanisms, subsystems and servo systems.

► **Cubic Corp.**, San Diego, Calif., takes over assets of **Digital, Inc.**, another small San Diego electronics firm. Purchase terms were not disclosed. Cubic develops and produces missile ranging and tracking systems. The acquisition is a step in planned expansion of Cubic's commercial activities.

► **KDI**, Rochester, N. Y., acquires precision products division of **Gruen Industries** of Cincinnati through cash purchase. Amount was not disclosed. Acquired Gruen division will be known as the **Precision Products Co.** of Cincinnati, a division of **KDI**. The division will remain under Paul Robert, former Gruen division manager. **KDI** manufactures automation equipment.

# SOLID-ELECTROLYTE **TANTALEX**<sup>®</sup> CAPACITORS

**new dimensions in miniaturization and reliability**



This solid-electrolyte Tantalex Capacitor (shown 1½ times actual size) is rated at 4.7  $\mu$ F, 10 volts d-c, and is only 1/8" in diameter by 1/4" long.

Now, circuit designers in computers and military electronics have an electrolytic capacitor that offers greater miniaturization than ever before . . . with no sacrifice in reliability. Sprague's recently announced solid-electrolyte Tantalex Capacitors find ideal application in the transistor circuits of these critical fields.

The tiny sintered tantalum anode of Type 150D Tantalex Capacitor is impregnated with a solid, non-corrosive, semi-conductor material which cannot leak under any circumstance. It combines true miniaturization with electrical stability previously unobtainable in an electrolytic capacitor of any type.

Thermal coefficient of these capacitors is sufficiently low and linear so that for the first time a circuit designer can think of an electrolytic in terms of parts per million capacitance change. Nominal value is +500 ppm/°C. The

capacitor may be used without derating over a range from +85°C to as low as -80°C, a temperature at which no other electrolytic has proved useful.

Solid construction permits the Type 150D to withstand the severe shock and vibration encountered in missile and ballistic applications. Hermetic sealing makes it completely immune to humid atmospheric conditions.

Complete performance data covering the wide range of sizes and ratings are in Engineering Bulletin 3520B, available on letter-head request to the Technical Literature Section, Sprague Electric Company, 35 Marshall Street, North Adams, Mass.

★ ★ ★

Sprague, on request, will provide you with complete application engineering service in the use of Tantalex Capacitors.

**SPRAGUE**<sup>®</sup>  
the trademark of reliability

SPRAGUE COMPONENTS:

CAPACITORS • RESISTORS • MAGNETIC COMPONENTS • TRANSISTORS • INTERFERENCE FILTERS • HIGH TEMPERATURE MAGNET WIRE • PULSE NETWORKS • PRINTED CIRCUITS

development of several United tubes. Their 542 rectifier, with 30 kv peak inverse rating and 100 ma average current, has recently been developed but is not yet in production. Clipper-diode 546, developed for high-power radar applications, has been made in only small quantities. Both of these tubes are still in the custom stage.

The small external anode diode 545 with a 5 kv peak inverse rating was specially made for power-supply use. Designed for immersion in oil for full ratings, the tube is now used as an air-cooled rectifier by customers other than its original purchaser. Although not EIA registered, it is being produced by the thousands and passing out of the custom stage.

Developed for fire control systems the clipper-diode 583 has left the custom stage and is produced by several companies.

► **Modifications** — Custom tubes often evolve through modification of existing tube types to satisfy special applications. For example, the request for a small 2C253 high-mu triode for a flight-simulation application led General Electronic of Patterson to make tube changes. The tube normally handles 1.5 ma plate current and has a transconductance of 750 to 1,000 micromhos. Since only a few microamps were desired, tube operation was near the knee of the plate characteristic and the gm was reduced to 250-300. The desire for a 2C253 with smaller-than-rated plate current necessitated tube redesign and eventual tube redesignation.

On the borderline of the custom tube designation are the many modified, long-life and ruggedized versions of existing vacuum tubes. Tube manufacturers often specially treat tubes to withstand shock and vibration and to extend tube life. Ericsson, the Swedish tube makers, use gold-plated tungsten wire in control grids to reduce secondary emission and guarantee longer life. And they gold plate tube pins to provide better high frequency performance. United uses a bonded thoria filament on some tubes to provide longer life.

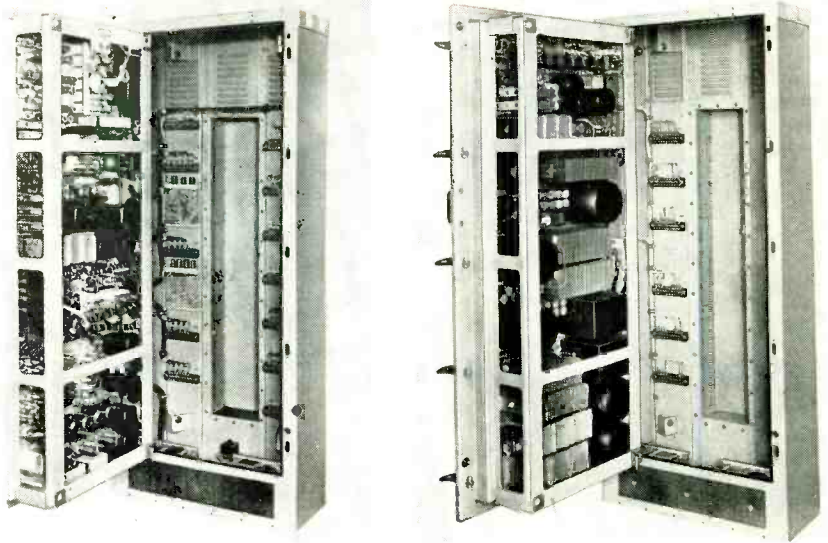

**DESIGN PLANNING** of new components with easily removed plug-in modules and built-in spares (left), and systems with good terminal board accessibility (right) is one way industry is meeting the challenge to retain a high-maintainability level of modern electronics as . . .

## Meeting Airs Upkeep Problems

Industry, military leaders discuss maintenance issue in California this month

ONE OF THE SERIOUS problems confronting the military today is the efficient maintenance of sophisticated electronics equipment. The development of high-performance weapons requires top-flight maintainability. And the more complex the equipment, the more qualified the maintenance man must be. Although we have made remarkable advances in the development of equipment, it can be generally said that maintenance-skill levels have decreased. This problem places a heavy burden upon efficiency of the armed forces.

► **The Letter**—Last March, General C. S. Levine of the Air Force wrote to Dr. R. G. Baker of Electronic Industries Association. He requested that the electronics industry be alerted to support a program devoted to provide design-for-maintenance in future equipment that would alleviate the maintenance burden. He felt confident that industry would meet this latest challenge. He said that in no other way can we invest so

little and gain so much in effectiveness for the Air Force.

► **The Conference**—The General's letter was one of the major reasons for considering the EIA Conference On Maintainability Of Electronic Equipment which is being held at the University of Southern California this month (18th and 19th). The General's problem is not unique to the Air Force, but applies to the other services as well as to our whole economy.

The conference provides an exchange of ideas in problem areas. Projected solutions will be advanced by both the military and private industry.

Technical sessions and panel discussions are planned to avoid academic and theoretical papers. The conference is confined to practical or applied papers. Plans are laid for conducting essentially identical sessions on the East Coast next spring.

► **Techniques**—Papers will be presented on advanced maintenance techniques for missiles, digital computers and radar, where search, fire control, aerodynamic navigation and weapons delivery

(Continued on page 14)

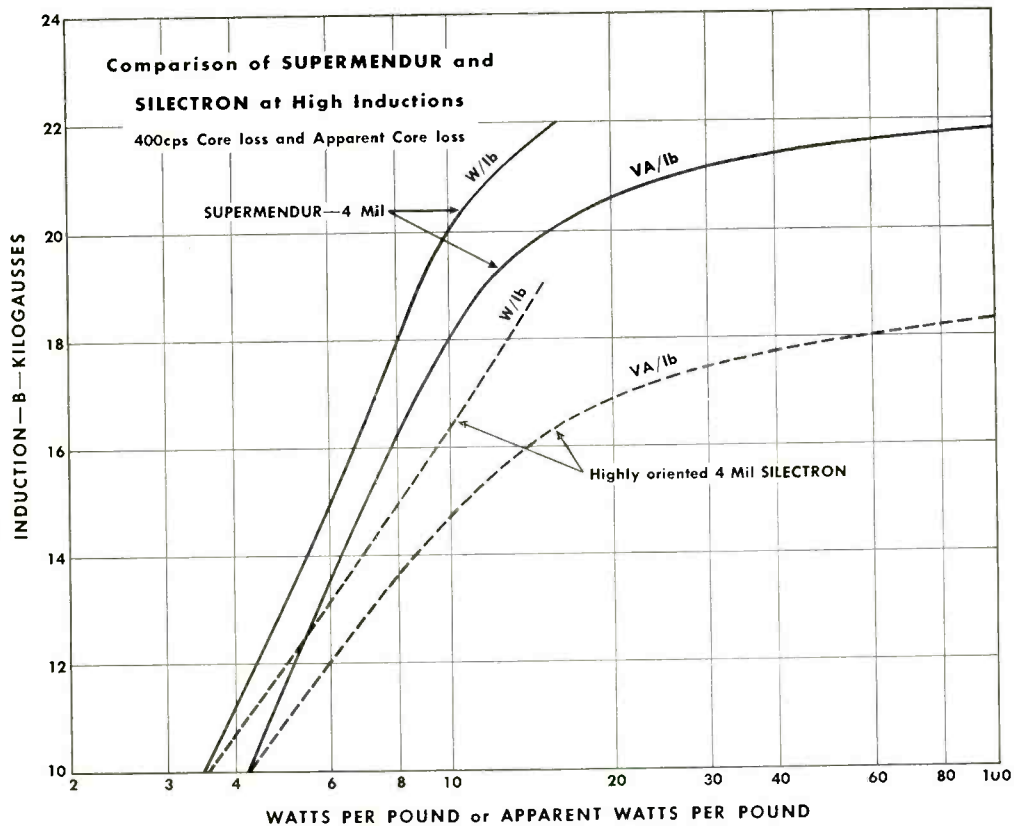

Announcing

**SUPERMENDUR**

## A New Rectangular-Loop Core Material

### For Miniaturized Transformers and Magnetic Amplifiers

Supermendur, an oriented cobalt-iron-vanadium alloy, combines the high saturation flux density of the cobalt-iron alloys with the desired hysteresis loop rectangularity of the oriented 50% nickel-irons. This gives it unique characteristics in the range of inductions from 16 to 22 kilogausses which permit miniaturization and weight reduction for toroidal transformers and magnetic amplifiers.

Coercive forces substantially lower than those of previously available cobalt-iron alloys are obtained. In the graph above, the lower core losses and excitation obtained with Supermendur show a decided improvement in high density characteristics compared with oriented silicon steel.

Supermendur can be processed in tape form to thicknesses

of 2 mils or less. Maximum utilization of its hysteresis loop rectangularity and high permeability at high induction requires a gapless or wound core type of construction particularly suited to thin tape.

*Specific advantages of Supermendur cores in toroidal transformers are: high operating induction, low core loss, low exciting current and high permeability at high induction. In magnetic amplifiers or saturable reactors, they include: rectangular hysteresis loop, high saturation induction and moderate excitation at high induction. Advantages in all uses are: thin tape, small size and low weight.*

Supermendur is manufactured under license arrangement with the Western Electric Company. • Call on us for more information or engineering assistance.

WSW 6921

#### Technical Information and Samples

Requests for sample toroidal cores of Supermendur in 4 and 2 mil thicknesses will be processed as rapidly as possible. Technical data will be released as it becomes available. When writing, state application, frequency, size, gage, characteristics desired and quantity required.

ADDRESS DEPT. E-712

## THE ARNOLD ENGINEERING COMPANY



Main Office & Plant: Marengo, Illinois

Repaph Pacific Division Plant: 641 East 61st Street, Los Angeles, Calif.

District Sales Offices:

Boston: 200 Berkeley St.

Los Angeles: 3450 Wilshire Blvd.

New York: 350 Fifth Ave. Washington, D.C.: 1001-15th St., N.W.

are all integrated. Complete consideration will be given to the ease and speed with which maintenance can be accomplished. Offered will be design techniques which will lead to convenient and rapid methods of locating faults and ease of replacement of components.

Cabinet designs, shown in the photographs, are presented as examples of RCA design techniques by R. M. Jacobs and B. F. Rogers. Those not attending the conference may get copies of the complete proceedings from Engineering Publishers, GPO Box 1151, New York 1.

## Uses of Transistor Limited in Radio-Tv

Cost, though dropping, still makes vacuum tube choice of home-instrument designers

THE TRANSISTOR may have solved many problems for the industrial electronics designer, but the cost-conscious home-instruments man must think twice before specifying it. Engineers in this field agree today that for them the vacuum tube is hardly beginning to show signs of obsolescence.

► **Cheaper Transistors**—Prices of semiconductor components are steadily dropping as production and sales rise, but they cannot yet compete dollar-wise with the tube. They are therefore used only where other advantages over tubes take precedence. Where space is a problem, or low hum, noise or freedom from microphonics is important, the transistor is frequently used. It is also employed in some instances where resistance to shock is a factor, or small low-voltage power supplies are essential.

► **Varied Utilization**—Thus in the 1958 tv receiver, where size is determined by the picture tube, the

transistor is almost nowhere to be seen. In home and auto radios and hi-fi sets, transistor uses are increasing slowly. But in the portable radio field the transistor really comes into its own, and there is used almost exclusively.

► **Smaller TV**—The trend in tv picture tubes is toward exclusive use of the 110-degree deflection type, which permits shorter tubes and consequently shallower cabinets. Most circuit improvements for the year have concentrated in this area, while one manufacturer has gone to the extreme in packaging,

with a tube face that extends out from the front of the cabinet, which is only 10 inches deep. Advantage claimed is the mounting of speakers on the front of the cabinet very close to the picture screen.

► **Radio Growing**—Radio sets of all types continue on the upswing, with most large production lines having reached the optimum in automation. Circuitry remains for the most part conventional, although research continues on the reflex and other cost-cutting cir-

(Continued on page 16)

## Military Electronics

► **Anti-submarine rocket** called ASROC, that can be launched from a ship a comfortable 200 miles from its target, is now being developed by Minneapolis-Honeywell for BuOrd. Described as a torpedo with a rocket, the weapon is aimed for the vicinity of the target and released. Once in the target area, the torpedo is turned loose from the rocket and seeks out the enemy sub or ship by means of "a searching device"—probably infrared.

ASROC, without the rocket, can be launched from an aircraft. Maximum range is probably shorter but ASROC's operation, once it hits the water, is basically the same.

Librascope is making the fire-control system. Launching system responsibility belongs to Universal Match. Payload will be produced by GE, turned over to BuOrd who will issue it in turn to prime contractor Minneapolis-Honeywell.

► **Wagtail**, air-to-ground, electronically guided rocket, is said to be using a "new type guidance method." Series of development contracts held by Minneapolis-Honeywell with the Air Force Armament Center, Elgin AFB, Fla., has gone considerably beyond the \$½ million mark announced earlier.

► **New digital computer** for military aircraft has been developed by Ramo-Wooldridge under contract with Westinghouse. Completely transistorized, the new RW-30 performs computations for navigation, fire control, bombing and weapons control. Complete computer has a volume of 4.19 cu ft and weighs 203 lbs. Subminiaturized packaging techniques and silicon semiconductor circuitry are used throughout. It can conduct 4,000 complete arithmetic operations per second, including access time, and requires 400 watts of power.



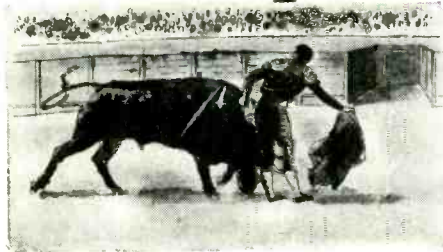
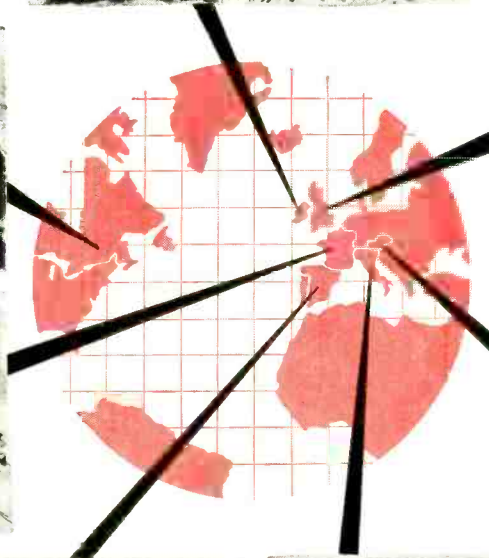
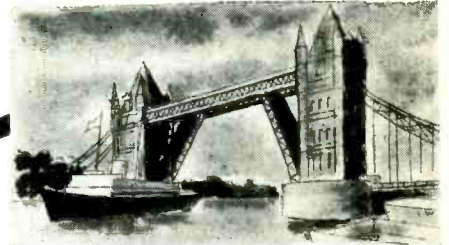
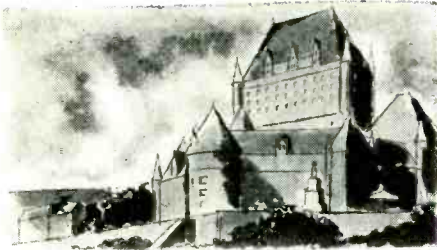

# Here, too, we make Nichrome\*

Perhaps you didn't know that the world-famous alloy Nichrome is produced not only in The United States, but also in 6 Driver-Harris plants in England, Ireland, France, Italy, Austria, Spain, and in Canada by The B. Greening Wire Company. Also, Nichrome is a registered trade-mark in 55 nations.

At first, fifty-odd years ago, we manufactured electrical resistance alloys for furnace elements and domestic

heating appliances only. Today we produce 132 different high nickel alloys in many different forms and in hundreds of sizes, for almost every kind of domestic and industrial application—of which Nichrome is the most illustrious.

Whenever you buy Nichrome, you are assured of the unsurpassed and unvarying *quality* which has made Nichrome the supreme world standard for electrical-resistance and heat-

resistant alloys. This uniformly high quality, which we jealously guard as our most priceless possession, results from the technical excellence, the productive skill, and the quality controls the Driver-Harris craftsmen have gained in over 50 years of experience — and which are maintained with equal rigor in all Driver-Harris plants here and abroad. The result is a continuous benefit to the entire electrical, electronic, and heat-treating industries.

\*T.M. Reg. U. S. Pat. Off.



*Nichrome is made only by*

## **Driver-Harris** COMPANY

**HARRISON, NEW JERSEY**

*Manufacturing plants also in: ENGLAND • CANADA • IRELAND • FRANCE • ITALY • AUSTRIA • SPAIN*

**MAKERS OF THE MOST COMPLETE LINE OF ALLOYS FOR THE ELECTRICAL, ELECTRONIC, AND HEAT-TREATING INDUSTRIES**

cuit trickery. Seasoned designers, however, feel that this is just the history of early radio repeating itself, and that as transistor prices continue to fall this type of development will fall by the wayside.

► **More Hi-fi**—Most major companies are taking a deep plunge into hi-fi, for the first time this season. While leaving the components field to the specialized small operators who pioneered it, big-company concentration is strictly on packaged merchandise for the home. Innovations this year include much emphasis on tape recorders, stereo and extension speakers.

► **Auto Mobile-Portable**—Biggest news in auto radios this year is the pull-out system which doubles as a portable. Fully transistorized, the unit uses the 12-volt car battery in mobile service, but only 6 volts from a group of heavy-duty penlite cells as a portable. A standard built-in miniature speaker is used in the portable, but a 6x9 oval automatically cuts in for auto use.

An additional power transistor is used to drive the car speaker, making the system a 9-transistor portable and 10-transistor mobile set. Separate antennas are also used for the two types of service. No vibrator is used, and this appears typical of a trend. Other

systems are now often hybrid, using tubes in low-power stages and transistors in the output, thus obviating the need for voltage step-up through the vibrator and vastly simplifying the power supply.

## Battery-Operated Tv

SWISS railway officials recently saw demonstrations of a battery-operated industrial tv system developed by Britain's Pye Ltd.

The portable equipment operated off two 12-volt car batteries in series to show rail alignment to engineers watching a receiver inside a moving train.

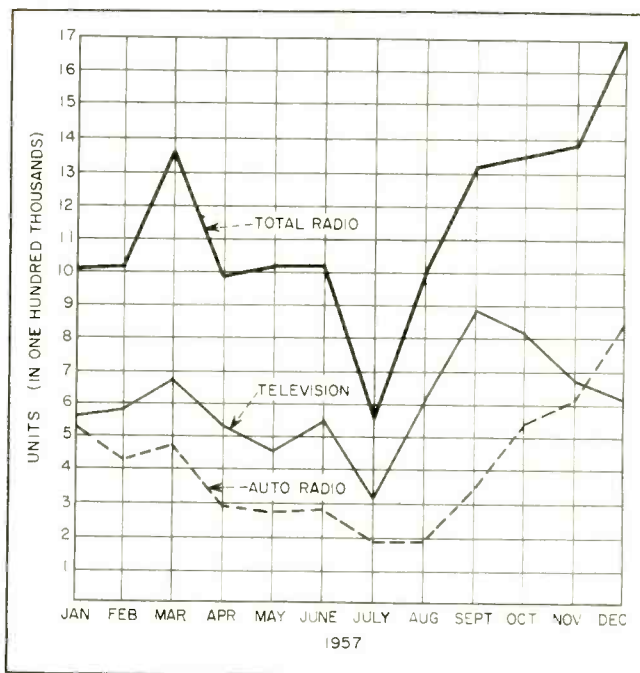
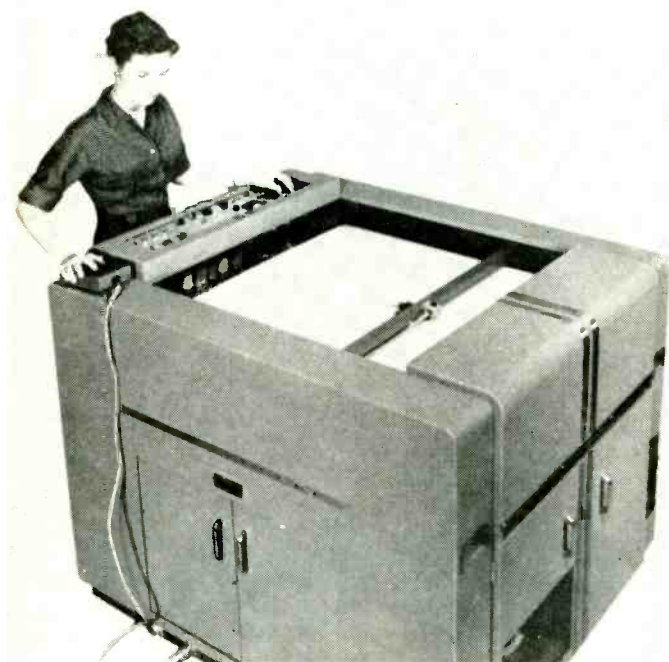

COMPETENT secretary with half a day of special training operates push button controls (left) to generate production report (right) as . . .

## Board Automatically Plots Business Trends

Integrator and memory also convert statistical information into easy-to-read bar charts

USERS of data processing equipment can now concurrently generate a continuous graphical presentation of digital information.

Digital-to-graphical conversion

medium, available for the first time, is the Dataplotter developed by Electronic Associates. It was recently demonstrated at the National Business Show in New York.

Information is fed into the plotter by punched cards, punched paper tape, magnetic tape, or a manually operated key-

board. An electronic memory device stores the initial input point until the next point is received. A special integrating circuit produces a signal which causes the recording pen to draw a continuous line between the two points on coordinate paper. This process

(Continued on page 20)

# Laboratory Accuracy Production-Line Speed



## Type 1605-A Impedance Comparator

- ✓ No manual balancing. Phase-angle and impedance-magnitude differences between the unknown and a standard impedance are read directly from two meters.
- ✓ An impedance bridge for *dynamic* measurement of impedance changes caused by varying environmental conditions.
- ✓ Can be readily incorporated into automatic-sorting equipment.

**Wide Range of Internal-Test Frequencies**  
100, 1000, 10,000 and 100,000 cps.

**Impedance Range**  
Resistance: 2 ohms to 20 megohms  
Capacitance: 40  $\mu\text{f}$  to 500  $\mu\text{f}$   
Inductance: 20  $\mu\text{h}$  to 10,000  $\mu\text{h}$

**Direct-Reading Meter Ranges**  
Impedance-Magnitude Differences:  
0.3%, 1%, 3%, and 10% of full scale.  
Phase-Angle Differences:  
.003, .01, .03, 0.1 radians full scale.

**Over-All Accuracy**  
3% of full scale (.01% over-all accuracy on 0.3% impedance magnitude range).

**\$790**

**VITRAMON**  
INCORPORATED

manufacturers of vitreous enamel dielectric capacitors, have taken full advantage of the Impedance Comparator's versatility:

**Engineering** The Impedance Comparator's ability to perform dynamic measurements without instrument readjustments allows considerable convenience in development. Capacitors, placed in a test cabinet containing a heating lamp and reflector, are measured for changes in dissipation factor and capacitance with temperature. The continuous measuring feature of the bridge eliminates any need for thermostatic heat control; the operator simply records thermocouple temperature and Comparator readings to obtain an accurate plot of conditions.

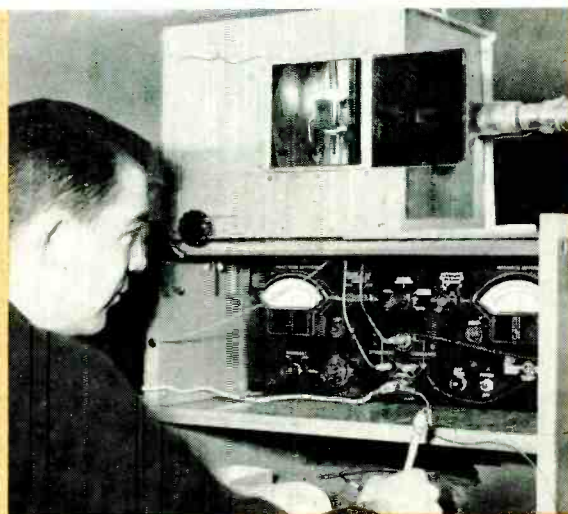

**Pre-Production** A statistical sampling of capacitors from each production lot is subjected to accelerated life tests at 130°C and 150% of rated voltage for 250 hours. These life-test measurements for dissipation factor and capacitance give information as to dielectric quality. Pre-production samples are also measured to determine mean and extreme capacity values so that the distribution of each production lot is known. Accurate data from the Impedance Comparator make effective production control at "VITRAMON" a certainty.

**Post-Production** A G-R Type 722 Precision Capacitor, converted for guarded operation, is used as a standard. Easy and rapid testing provided by the "No-Knob" balancing feature of the Impedance Comparator permits "VITRAMON" to perform a 100 per cent check of production lots without significant increases in labor costs.

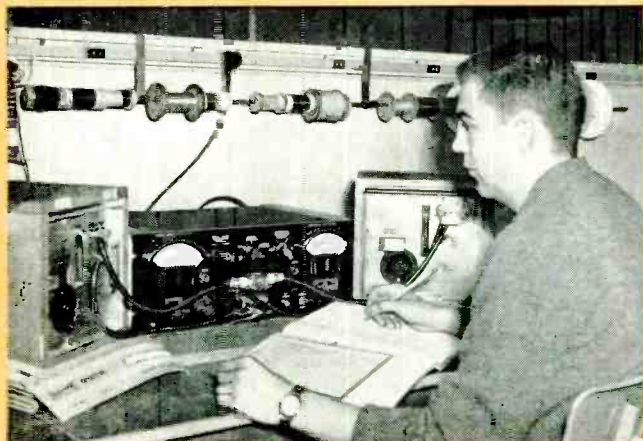

## GENERAL RADIO Company



275 Massachusetts Avenue, Cambridge 39, Massachusetts, U. S. A.

All G-R Products  
are now covered by a

**2-Year Warranty**

Broad Avenue at Linden, Ridgefield, N. J. **NEW YORK AREA** 1000 N. Seward St. **LOS ANGELES 38**  
8055 13th St. Silver Spring, Md. **WASHINGTON, D. C.** 1150 York Road, Abington, Pa. **PHILADELPHIA**  
1182 Los Altos Ave., Los Altos, Calif. **SAN FRANCISCO** 6605 W. North Ave., Oak Park, Ill. **CHICAGO**

In **CANADA**: 99 Floral Parkway, **TORONTO 15**

**CIRCLE 105 READERS SERVICE CARD**



# SILICON and GERMANIUM

The types pictured and charted on these pages possess the characteristics and the dependability to merit your specification and your confidence.

## BONDED SILICON DIODES

Type	Peak Inverse Volts	Forward Current (min.) at +1V mAdc	Average Rectified Current mAdc (25°C)	Reverse Current	
				$\mu$ A	at V
1N300	15	15	65	0.001	10
1N300A	15	30	80	0.001	10
1N432	40	10	55	0.005	10
1N432A	40	20	70	0.005	10
1N301	70	5	45	0.05	50
1N301A	70	18	65	0.05	50
1N460	90	5	45	0.1	75
1N460A	90	15	60	0.1	75
1N303	125	3	40	0.1	100
1N303A	125	12	55	0.1	100
1N433	145	3	40	0.1	125
1N433A	145	10	50	0.1	125
1N434	180	2	35	0.1	150
1N434A	180	7	45	0.1	150
1N302	225	1	30	0.2	200
1N302A	225	5	40	0.2	200
CK863	300	1	20	0.3	275
CK863A	300	3	30	0.3	275

## GOLD BONDED GERMANIUM DIODES

Type	Peak Inverse Volts	Average Rectified Current (max.) mAdc	Reverse Current at -10V $\mu$ A
1N305	60	125	2
1N306	15	150	2
1N307	125	50	5

## GENERAL PURPOSE GERMANIUM DIODES

Type	Peak Inverse Volts	Average Rectified Current (max.) mAdc	Reverse Current $\mu$ A at V
1N66	60	50	800
1N67	80	35	50
1N68	100	35	625
1N294	60	50	800
1N297	80	35	100
1N298	70	50	250
VHF and UHF			
1N295	40	35	200
CK715	40	35	—

## SILICON POWER RECTIFIERS

Type	Peak Inverse Volts	Average Rectified Current Amps. (125°C*)	Reverse Current (max.) at FIV mAdc
CK774	25	5	5
CK775	60	5	5
CK775-1	125	5	5
CK776	200	5	5
CK777	325	5	5

\*Case Temperature

ACTUAL SIZE



YOUR DESIGN IS BETTER  
YOUR PRODUCT PERFORMS BETTER **when you use RAYTHEON SEMICONDUCTORS**

# DIODES and RECTIFIERS

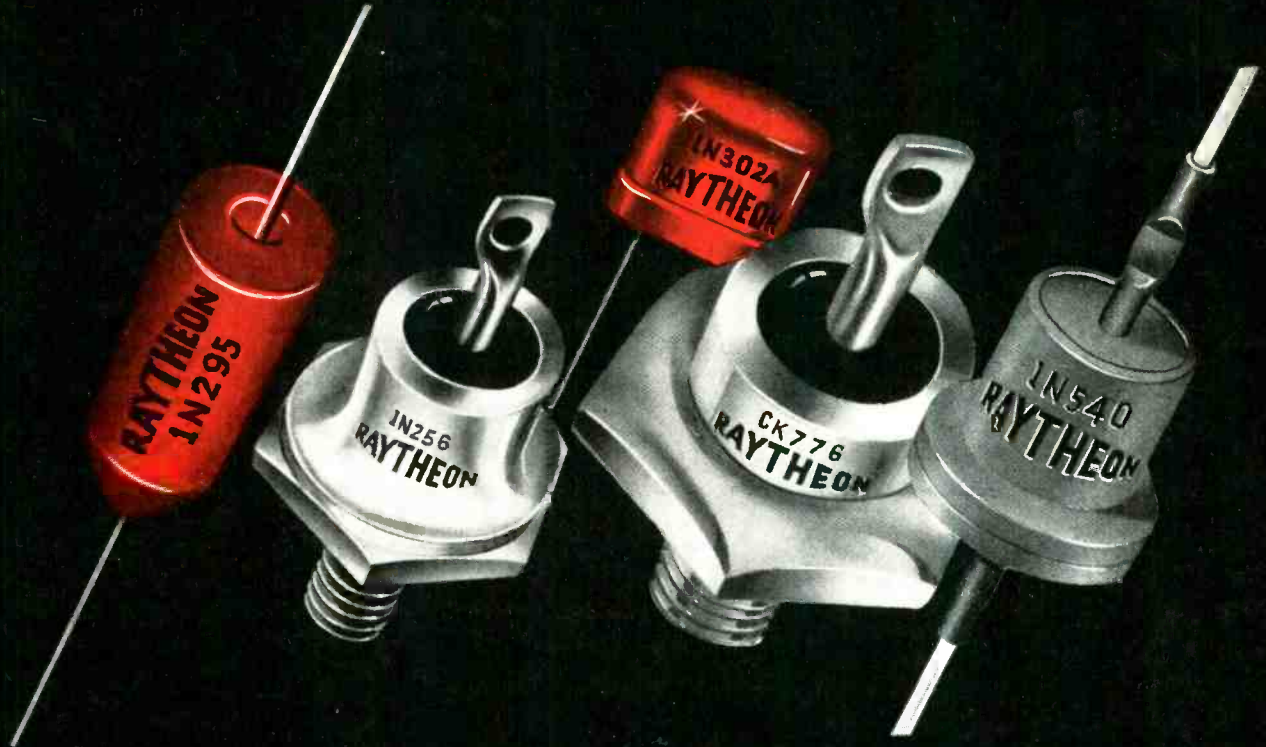

## DIFFUSED JUNCTION SILICON RECTIFIERS

A STUD TYPE				B WIRE-IN TYPE							
Type	Peak Inverse Volts	Average Rectified Current Amps. (150°C)	Reverse Current (max.) at PIV $\mu$ A	Type	Peak Inverse Volts	Average Rectified Current Amps. (135°C)	Reverse Current (max.) at PIV $\mu$ A	Type	Peak Inverse Volts	Average Rectified Current Amps. (150°C)	Reverse Current (max.) at PIV $\mu$ A
CK846	100	1.0	2	1N253	95	1.0	10	1N537	100	0.25	2
CK847	200	1.0	2	1N254	190	0.4	10	1N538	200	0.25	2
CK848	300	1.0	2	1N255	380	0.4	10	1N539	300	0.25	2
CK849	400	1.0	2	1N256	570	0.2	20	1N540	400	0.25	2
CK850	500	1.0	2					CK844	500	0.25	2
CK851	600	1.0	2					CK845	600	0.25	2



**SEMICONDUCTOR DIVISION**

Silicon and Germanium Diodes and Transistors • Silicon Rectifiers

Newton, Mass.: 55 Chapel St., Bldg. 4-7500  
 New York: 589 Fifth Ave., Plaza 9-3900  
 Chicago: 9501 Grand Ave., Franklin Park, TUxedo 9-5400  
 Los Angeles: 5236 Santa Monica Blvd., NOrmandy 5-4221

takes 1½ seconds and is repeated for each incoming point.

It is felt the Dataplotter will enable non-mathematically trained people to interpret the flood of facts and figures turned out by high speed electronic computers and data processing equipment. Also, hard pressed management personnel can reduce reports, studies, profit and loss statements, break-even figures, or forecasts, into comprehensive graphs much faster and cheaper than at present.

► **Physical makeup**—Except for the memory and integrating circuits, this plotter contains the same components and functions found in EA's Variplotter. Since it was designed with compatibility in mind, the Dataplotter can be used without modification by companies having IBM or similar output equipment.

► **Accuracy**—Plotter is accurate to

within 0.015 thousandths of an inch over a 30-inch pen translation. Drawings can be made on postage-stamp size paper or 30-by-30-inch sheets. Vacuum plate holder prevents paper from wrinkling.

► **Versatility**—It is possible to extend plots at future dates by inserting original plus additional data. Pen will retrace over first plot and continue the graph. If point plotting is desired, twelve dots symbols are provided to identify input information. Two-pen and four-pen carriages can be used to simultaneously plot as many as four related variables.

► **Applications**—First unit manufactured was purchased by Photonics of Columbus, Ohio to help plot lateral profiles of proposed new highways. Federal Reserve intends to use the device for preparing a greater number of charts for annual presentation to Con-

gress. Anticipated future markets include: brokerage houses for keeping constant visual records of stock trends in relationship to Dow-Jones averages; insurance companies for preparing actuarial graphs; chain stores for giving hour-by-hour plot of sales as against sales of previous day, week or year; factories for making daily plots of inventory, expense and payroll data; and topographical mapping for drawing accurate profiles of terrain features.

► **Cost**—Unit is currently selling for \$22,000 with 120-day delivery. Custom models for particular applications can be made for additional cost. By March, EA expects to be able to provide 30-day delivery. A transistorized version of the plotter is presently being designed. A demonstration unit is installed at the Princeton Computation Center at Princeton, New Jersey.

## Manometer Checks Blood Pressure in Veins

Sturdy meter now permits measuring of blood flow to sick person's heart

RAPID ELECTRONIC developments have frequently facilitated advances in medical technology. Still another example of this is now provided by the recent disclosure that the Gauer pressure manometer for measuring blood pressure in the veins has been in effective use at the Veterans Administration Hospital in Durham, North Carolina.

While measurements of arterial pressure have been commonplace, means of measuring blood flow to the heart have only recently been found. The Gauer manometer, about 12 mm in length and 3 mm in diameter can easily be inserted into the vein and passed up into the chambers of the heart.

► **Description** — Blood pressure variations depress a small rubber-capped disk at the end of the

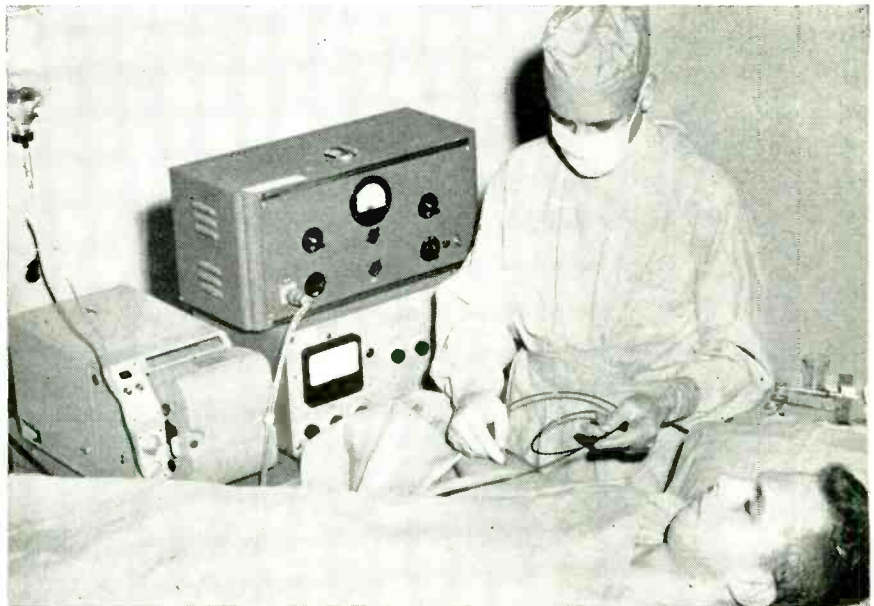

DOCTOR inserts tiny manometer into patient's vein

manometer. This compresses a tiny coil spring which displaces a piston. Soft iron, acting as the armature of a differential transformer,

is attached to the opposite end of the piston. As the piston position is varied through pressure altera-

(Continued on page 22)

# NEW T/PLOTTER CUTS VIBRATION TEST TIME 50% to 75%

Automatically Plots Detailed  
Curves of Transmissibility



Immediate evaluation of system transmissibility is made possible by the new Barry-Insco T/Plotter which automatically draws a continuous curve of transmissibility. The T/Plotter eliminates data processing and conversion, and ends laborious point-by-point recording, calculating, and curve plotting. And because the recorded curve is *continuous*, there is no danger of missing significant peaks through arbitrary choice of points in the plotted curve.

### How it works

Vibration pickups on the shaketable and on the test specimen feed their a-c voltage outputs into identical amplifiers and rectifiers in separate channels of the T/Plotter. The instrument's servo system responds to the difference between the two voltages, which is a measure of transmissibility.

Fast scan over the entire frequency spectrum quickly shows resonance points, and slow scan provides detailed analysis of these resonances, (see curves below).

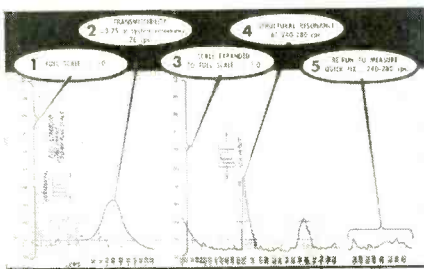

### Measurement range

The T/Plotter can be set for full-scale ranges of 0.2, 1.0, 10, and 100. Any standard laboratory vibration pickup can be used. Frequency range is from 5 to 4000 cps. Accuracy is  $\pm 2\%$  to 2000 cps,  $\pm 2\frac{1}{2}\%$  above 2000 cps. Chart speed is variable from 6 to 960 inches per hour, in 16 steps.

Released time for laboratory equipment and personnel, resulting from the faster and more accurate measurements possible with the T/Plotter, expands the capacity of present lab facilities — without adding space, shakatables, control or metering apparatus to existing equipment. Write for Bulletin 57-04 that tells how you can cut vibration-test time 50 to 75%.

# How to design for RELIABILITY UNDER SHOCK and VIBRATION

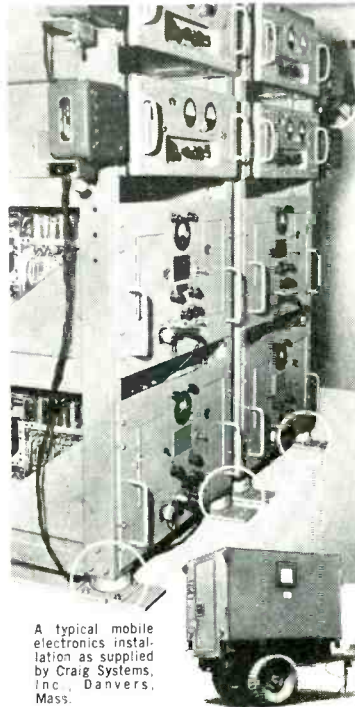

A typical mobile electronics installation as supplied by Craig Systems, Inc., Danvers, Mass.



To protect electronic gear against road shock during travel over rough terrain, Barry Cup-mounts supporting equipment racks of mobile air-traffic-control units combine effective protection against high-impact shock with efficient isolation of vibration frequencies above 45 cps. This isolates the structural resonances of the vehicle, with no amplification of vibration from tires and springs. In other applications, these mounts protect against the high transients of gun-fire shock. Details of load ratings, sizes, and characteristics — with useful data on choosing Cup-mounts — are yours in Barry Product Bulletin 56-02, free on request.

FOR VEHICULAR SERVICE

### LANDING-SHOCK CURVES

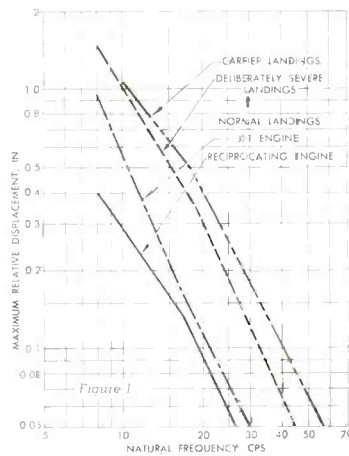

To protect sensitive electronic equipment in jet aircraft against landing shocks, while maintaining in-flight vibration isolation, mounts must be able to withstand the severe conditions indicated by the curves of Fig. 1, plotted from actual measured landing shocks. ALL-ANGL Barry Mounts, having natural frequencies above 25 cps, keep shock displacements within reasonable limits. Load-deflection curves, for this family of isolators that give protection under high thrust loads applied in any direction, are shown in Fig. 2. For complete performance data on ALL-ANGL Barry Mounts, write for Data Sheet 57-02.

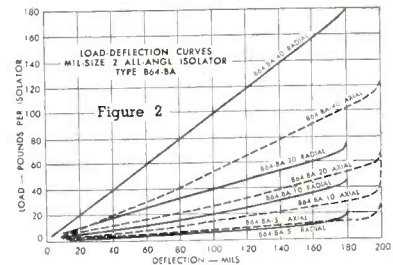
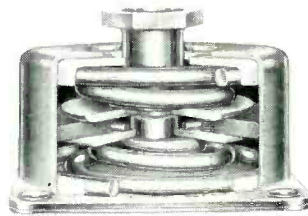

FOR AIRCRAFT SERVICE

# BARRY CONTROLS INCORPORATED

## BARRY B MOUNT

SALES REPRESENTATIVES  
IN ALL PRINCIPAL CITIES

707 PLEASANT STREET, WATERTOWN 72, MASSACHUSETTS

tions, the relative coupling of the transformer changes.

The transformer functions as one leg of a bridge circuit of a two-stage amplifier.

Physicians hope that with further use of the manometer many unanswered questions about heart failure and circulatory disorders can be answered.

## Oil Industry Looks To Computers

Increased computer orders brighten prospects for petroleum progress

RAPID ADVANCES in computer technology are making better, faster and more efficient computers an actuality. Some industries which previously considered the cost of purchasing or renting high-speed computers and the training of personnel to be prohibitive are now turning to electronics.

In the oil industry alone a 45 percent increase in the number of computers now in use is predicted by a survey conducted by *Petroleum Week*, a McGraw-Hill publication. The replies from electronics' people of 37 leading oil companies indicate that 84 large and medium-sized computers are now in use and orders for 38 more units have been placed.

► **Conversion**—Electronic retooling is still in the early stages. But 19 companies, recognizing the need for an integrated electronic program, have installed formal committees at the policy level to develop and administer activity.

► **Application**—Present computer uses divide fairly evenly between accounting and scientific research, but electronics experts envision a greater emphasis upon scientific and operations research. Other applications include refinery operations and planning, refinery simulation and research and development.

All firms have made studies, costing from \$1,000 to \$500,000, into computer uses for oil.

## FCC Actions

► **Amends** table of tv assignments, giving channel 13 to Fajardo, P. R., taking channel 12 from Charlotte Amalie, Virgin Islands, and assigning it to Aguadilla-Arecibo, P. R., in place of channel 13.

► **Changes** its rules so that cutoff date for consolidating and designating broadcast applications for hearing conforms to cutoff date for such applications granted without hearing.

► **Grants** permission to RCA Communications for point-to-point transmissions to and from Nicosia, Cyprus, both directly and through its relay station at Tangier.

► **Assigns** channel 12 to Mankato, Minn.; changes offset carrier requirement for that channel from even to minus in Brainerd, Minn., and from minus to plus in Ironwood, Mich.

► **Proposes** to delete channel 227 from Tacoma, Wash., substitute channel 284 for 279 in Olympia, Wash., and 289 for 284 in Centralia, Wash. Purpose is to add class A channel 280 to Tacoma.

► **Denies** request of Maryland & Virginia Milk Producers Association for control station of Special Industrial Radio Service in urban Washington, D. C.

► **Provides** for licensing of Land and Mobile Radio-positioning stations to operate speed measuring devices that use cw emissions at 2,455 and 10,525 Mc. Operation of such devices above 890 Mc continues on a developmental basis.

► **Grants** Western Union permission to increase message rates from Gibraltar and Malta to the U. S. and possessions, gives the telegraph company authority to reduce service at one station, discontinue 15 others.

► **Financing**—Most of the surveyed companies insist upon a projected economic payout for computers before placing orders.

Furthermore, 25 firms reported that they would probably continue to rent, rather than buy, large and medium-sized computers. Eight electronics' people were unsure about what company policy would be.

► **Improvements**—Among the computer characteristics desired by oil people are self-editing and common language features, unlimited storage and validity checking devices on all types of machines.

## Transistors Slash Telemetering Costs

As systems grow larger, transistors reduce needs in power and repair

TRANSISTORIZATION of multichannel telemetering and control systems can save money in operation and maintenance, according to an investigation made by the Warren Manufacturing Co. In addition, weight is reduced by 75 percent (compared with tube systems) and

(Continued on page 24)



**HIGH Output** (1.0 v. RMS into 70 ohms)  
**WIDE Range** (2-220 Megacycles. All At Fundamental)  
 and  
**CONSTANT OUTPUT**  
 (Fast Acting AGC)



High Output . . .



1.0 V RMS  
INTO 70 OHMS

**SPECIFICATIONS**

- Range:** Fundamental frequency 2 to 220 mc., continuously variable in 10 switched overlapping bands. Direct reading frequency dial
- RF Output:** 1.0 v. RMS into 70 ohms, metered. Flat within  $\pm 0.5$  db over widest sweep and frequency band.
- Sweep Width:** Continuously variable to  $\pm 30\%$  of center frequency to maximum of at least 30mc.
- Sweep Rate:** Continuously variable 10 to 40 cps.; also locks at line frequency.
- Attenuator:** Switched 20, 20, 10, 6, and 3 db plus continuously variable 6 db.
- Power Supply:** Electronically regulated 105 to 125 v. A.C. 50 - 60 cycles

**KAY**

*Vari-Sweep*

**ALL-ELECTRONIC HIGH LEVEL SWEEPING OSCILLATOR OR, (with sweep off) CONTINUOUSLY TUNED CW SIGNAL SOURCE**

- Operates On Fundamental Frequency, Therefore Stable Narrow-Band Sweeps
- 1.0 v. RMS (into 70 ohms) Output Flat to  $\pm 0.5$  db Over Widest Sweep
- Output Automatically Held Constant (AGC) Over Complete Range
- Variable Sweep Width (to 30 mc. PLUS) — Variable Center Frequency
- Direct Reading Frequency Dial Accurate To  $\pm 4.0\%$
- High Accuracy Attenuator
- Sweep Repetition Rates Down to 10 cps

Price: **\$695.** FOB Plant

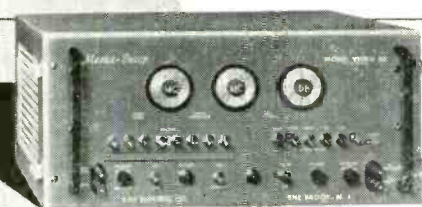

**NEW KAY *Marka-Sweep* MODEL VIDEO 50**

Combined Video and IF Sweeping Oscillator with Marks

**SPECIFICATIONS**

- Frequency Range:** Continuously variable, 50 kc to 50 mc.
- Sweep Width:** Linear, continuously variable, 4.0 mc to 50 mc.
- Sweep Rate:** Variable around 60 cps; locks to line frequency.
- Amplitude:** 1.0 v, peak-to-peak, into nom. 70 ohms. Flat within  $\pm 0.5$  db over widest sweep.

- Attenuators:** Switched 20, 20, 10, 6 and 3 db, plus continuously variable 3 db.
- Markers:** Eight sharp, pulse-type, crystal-positioned, internal and external markers.
- Price:** **\$695.00** F.O.B. Factory. Substitute markers, \$10.00. Additional markers, \$20.00 each.

**KAY ELECTRIC COMPANY**

14 MAPLE AVENUE PINE BROOK, N. J. CAIDwell 6-4000

Dept. E-12

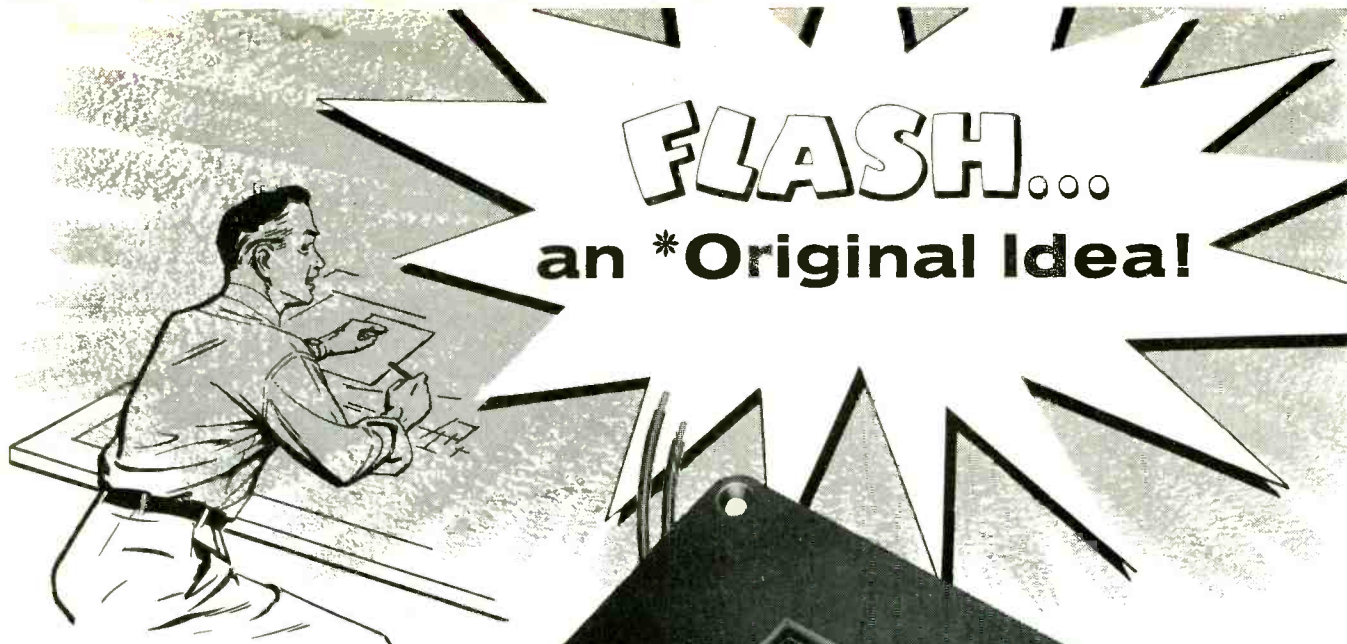

**FLASH...**  
**an \*Original Idea!**

**You Can  
 Count On...  
 to Pay Off!**



Series 1205  
 Reset Magnetic Counter

It's the *\*Original Equipment* idea . . . which simply means that, when you're figuring on electrical or mechanical counters in any new product, it pays to *design them in, when you begin.*

For then Veeder-Root quite likely can save you time and money by adapting or modifying a *standard* counter to your needs, instead of a special which you might specify on your own. This solves the counter problem . . . and saves you time in engineering, purchasing and assembly.

What's more, you give your product new sales-advantages: Direct-reading digits, instead of hard-to-read dials and verniers . . . instant remote indication if needed . . . up-to-the-minute performance records that serve as a basis for production-*Control*, and as proof of your performance guarantee. So don't let counters take a back seat in your new-product plans. *Design them in, when you begin . . .* it pays in many ways. Do you have the newest Veeder-Root Catalog? Write

*Everyone  
 Can Count on*  
**Veeder-Root**  
**INCORPORATED**



Hartford, Conn. • Greenville, S. C. • Chicago • New York  
 Los Angeles • San Francisco • Montreal  
*Offices and Agents in Principal Cities*

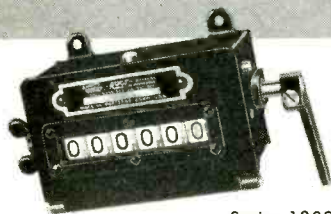

Series 1380  
 Box-Type Counter (Ratchet,  
 Revolution, or Geared)

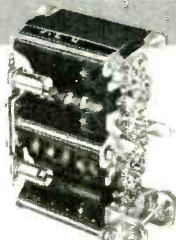

4-bank Counter for  
 Radio Transmission Equipment

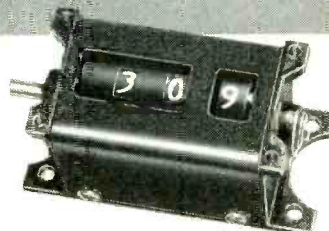

360-degree Bearing Counter

# VHF Transistors! First From PHILCO



## New family of Micro Alloy Diffused-base Transistors (MADT)\*

- Rise, Storage, Fall Time in Low  $\mu\text{sec}$  Range
- High Oscillator efficiency at 200 mcs
- Amplifier gains of 10 db at 200 mcs

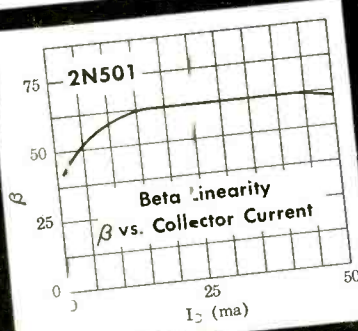
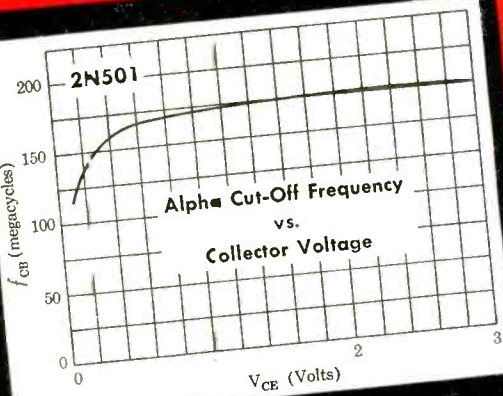

MADT FAMILY APPLICATIONS DATA

TYPE*	$f_{max}$	Power Gain	Oscillator Efficiency	Class of Use
2N499	250 mcs (min)	10 db at 100 mcs	25% at 100 mcs (min)	oscillator and amplifier to 100 mcs
2N500			25% at 200 mcs (min)	oscillator to 400 mcs
2N501		Ultra high-speed switch typical $t_r = 12 \mu\text{sec}$ ; (18 max.); $t_s = 7 \mu\text{sec}$ ; (12 max.); $t_f = 4 \mu\text{sec}$ ; (10 max.). In circuit with current gain of 10 and voltage turnoff.		
2N502†	500 mcs	10 db at 200 mcs		amplifier to 250 mcs
2N503†		11 db at 100 mcs (min)		amplifier to 100 mcs
2N504	50 mcs	46 db at 455 KC		high gain IF amplifier

\*Available in voltage ratings up to 35V and dissipation ratings to 100 mw.  
†In  $\epsilon$ -ETEC TO-5 Case (widely known as JETEC 30 Case).

Here is a major breakthrough in the frequency barrier . . . a new family of *field-flow* Micro Alloy Diffused-base Transistors. Philco MADT's extend the range of high gain, high frequency amplifiers; high speed computers; high gain, wideband amplifiers and other critical high frequency circuitry.

MADT's are available to various voltage and frequency specifications for design of high performance transistorized equipment through the entire VHF and part of the UHF spectrum. These transistors range in  $f_{max}$  from 250 mc to as high as 1000 mc. MADT gains are typically 10 db at 200 mc and greater than 16 db at 100 mc. A low cost general purpose unit is available which will deliver typically 18 db at 50 mc and 32 db at 10 mc.

Make Philco your prime source of information for high frequency transistor applications.

Write to Lansdale Tube Company, Division of Philco Corporation, Lansdale, Pa., Dept. E-1257

\*Trademark Philco Corporation for Micro Alloy Diffused-base Transistor

**PHILCO CORPORATION**  
LANSDALE TUBE COMPANY DIVISION  
LANSDALE, PENNSYLVANIA





## Sixty Volt Power Transistor Type 2N296

Sylvania develops a high voltage power transistor with optimum performance factors for a wide range of circuit applications.

Now Sylvania offers type 2N296, a PNP germanium alloy transistor designed for high voltage power amplifier or switching applications where supply voltages are 25-30 volts. The new unit is already finding growing use in computer, telephone and aircraft circuits.

The new 2N296 is physically identical with Sylvania type 2N242 and can be used as its high voltage companion.

### Here are the general features of the new 2N296

- 25 Watts. Max. Dissipation (Mounting base maintained at 25° C)
- 2 Amps Collector Current
- 60 Volts Max. Collector Voltage
- 0.8 Saturation Voltage (Typical)
- 20 Minimum Current Gain
- 85° C Storage Temperature
- 100° C Junction Temperature (Operating)
- Temperature Gradient (from junction to mounting base) 3° C/Watt
- New Welded Hermetic Seal Construction

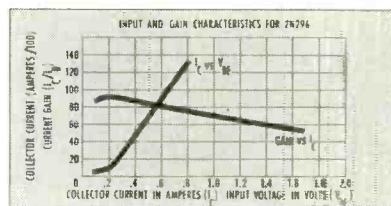

Input and Gain Characteristics for Type 2N296

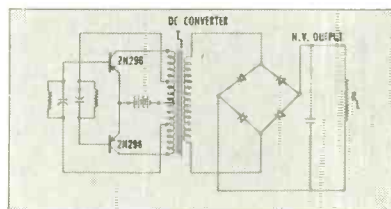

Transistorized DC Converter with Type 2N296

Call or write your Sylvania representative for complete particulars on the new 2N296 60-volt power transistor.

# SYLVANIA

SYLVANIA ELECTRIC PRODUCTS INC.  
1740 Broadway, New York 19, N.Y.  
In Canada: Sylvania Electric (Canada) Ltd.  
Shell Tower Bldg., Montreal

LIGHTING • RADIO • ELECTRONICS • TELEVISION • METALS & CHEMICALS

# NEW TRANSISTOR-CURVE TRACER

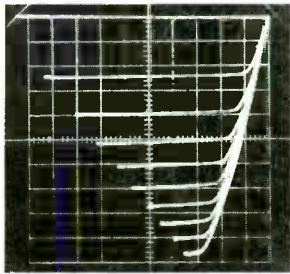

**HIGH COLLECTOR CURRENT**

PNP transistor, collector current vs collector voltage with constant-current base steps. Collector sweep is 0 to 5 v with a 0.25-ohm load, base current is 50 ma/step. Vertical deflection is 1000 ma/div, horizontal 0.5 v/div.

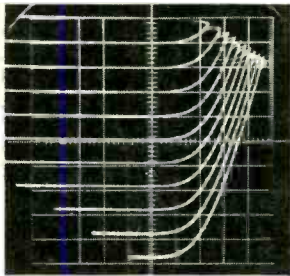

**HIGH INPUT CURRENT**

PNP transistor, collector current vs collector voltage with base grounded and constant-current emitter steps. Collector sweep is 0 to 1.5 v, emitter current 200 ma/step. Vertical deflection is 200 ma/div, horizontal 0.1 v/div. Zero voltage is at center scale.

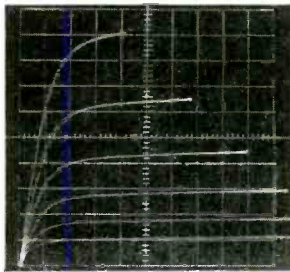

**LOW INPUT CURRENT**

NPN transistor, collector current vs collector voltage with constant-current base steps. Collector sweep is 0 to 1.5 v, base current 1 microamp/step. Vertical deflection is 10 microamp/div, horizontal 0.1 v/div.

**has 10-AMPERE COLLECTOR SUPPLY  
2.4-AMPERE BASE SUPPLY**

**Displays 4 to 12 curves per family  
with input current from  
1 MICROAMP/STEP  
to 200 MILLIAMPS/STEP**

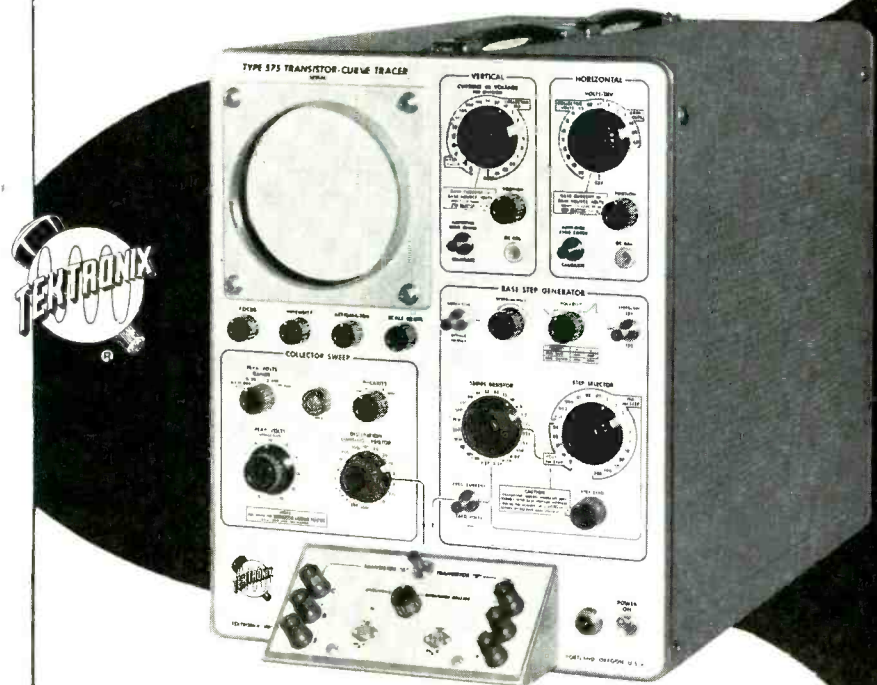

The Tektronix Type 575 traces characteristic curves for both PNP and NPN transistors on the face of a cathode-ray tube. Seven different types of curves can be plotted. Vertical deflection is calibrated in collector current, base voltage, base current and base source voltage. Horizontal deflection is calibrated in collector voltage, base voltage, base current and base source voltage. Collector current supply is capable of 10 amperes from 0 to 20 v, 1 ampere from 0 to 200 v. Constant current or constant voltage step supply to either base or emitter is calibrated in 17 values from 1 microamp/step to 200 milliamps/step, and in 5 values from 0.01 v/step to 0.2 v/step with 24 values of driving resistance from 1 ohm to 22 kilohms. Input steps are adjustable from 4 to 12 per family, with repetitive or single-family display.

TYPE 575 TRANSISTOR-CURVE TRACER . . . \$925

f.o.b. Portland, Oregon

## Tektronix, Inc.

P. O. Box 831 • Portland 7, Oregon

Phone CYpress 2-2611 • TWX-PD 311 • Cable: TEKTRONIX

First shipments against a sizeable backlog occurred early in November. Please check with your Tektronix Field Engineer or Representative for current Type 575 shipping schedule.

**ENGINEERS**—interested in furthering the advancement of the oscilloscope? We have openings for men with creative design ability. Please write Richard Ropiequet, Vice President, Engineering.

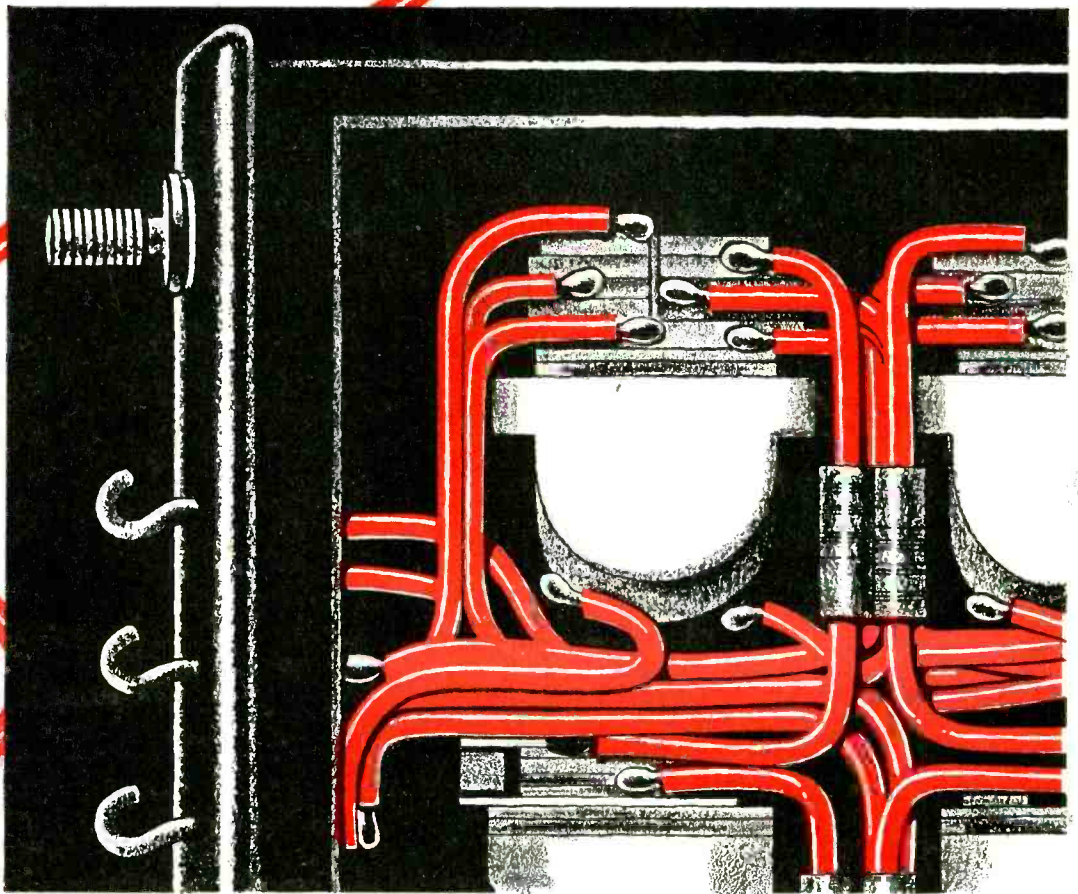

## **STAYS** flexible under temperature extremes

This group of hermetically sealed aircraft relays must function through a temperature range of  $-70^{\circ}\text{F}$ , to  $+450^{\circ}\text{F}$ , under prolonged frequency vibration.

They are insulated with BH "1151" Glass Fiber Silicone Elastomeric Sleeving to stay flexible from  $-90^{\circ}\text{F}$  to  $+600^{\circ}\text{F}$ . Not affected by heat ageing.

Temperature extremes, vibration, shock, rough assembly handling, soldering temperatures — all are factors that can cause rapid failure of ordinary insulation sleeving . . . but not BH Flexible Sleeveings.

Their flex-life has been production tested and proved.

Pioneers in flexible electrical insulation tubings and sleeveings, BH has a product for practically any application. Send us a few facts on temperatures to be encountered, unusual conditions to be met, we'll gladly send you samples for testing.

**BENTLEY, HARRIS MANUFACTURING CO.**

1200 Barclay Street

CONSHOHOCKEN 4, PA. TELEPHONE: TAYLOR 8-0634

**BENTLEY, HARRIS**

*Flexible*

**SLEEVINGS**

BH Non-Fraying glass fiber sleeveings are made by exclusive Bentley, Harris process (U.S. Pat. Nos.: 2393530; 2647296 and 2647299).



# Get out your pencil and . . .

## Help yourself to

# electronics' READER SERVICE

## it's free—it's easy—it's for your convenience

**NOW!**

All Advertisements  
New Products, and  
New Literature are  
numbered for your  
convenience.

Each Advertisement, New Product, and New Literature item is numbered.

For more information simply . . .

- (1) Circle number on postpaid card below that corresponds to number at the bottom of Advertisement or New Product item. Follow the same procedure if you desire New Literature.
- (2) Print your name, title, address, and firm name carefully. It is impossible to process cards that are not readable.

Correct additional postage **MUST** be added to cards for all **FOREIGN MAILINGS**

**DEC**

**1 • 57**

**CARD  
EXPIRES  
MAR • 1ST**

• **electronics** • **READER SERVICE CARD**

Please Print Carefully

NAME \_\_\_\_\_ POSITION \_\_\_\_\_

COMPANY \_\_\_\_\_

ADDRESS \_\_\_\_\_

1	2	3	4	5	6	7	8	9	10	11	12	13	14	15	16	17	18	19	20
21	22	23	24	25	26	27	28	29	30	31	32	33	34	35	36	37	38	39	40
41	42	43	44	45	46	47	48	49	50	51	52	53	54	55	56	57	58	59	60
61	62	63	64	65	66	67	68	69	70	71	72	73	74	75	76	77	78	79	80
81	82	83	84	85	86	87	88	89	90	91	92	93	94	95	96	97	98	99	100
101	102	103	104	105	106	107	108	109	110	111	112	113	114	115	116	117	118	119	120
121	122	123	124	125	126	127	128	129	130	131	132	133	134	135	136	137	138	139	140
141	142	143	144	145	146	147	148	149	150	151	152	153	154	155	156	157	158	159	160
161	162	163	164	165	166	167	168	169	170	171	172	173	174	175	176	177	178	179	180
181	182	183	184	185	186	187	188	189	190	191	192	193	194	195	196	197	198	199	200
201	202	203	204	205	206	207	208	209	210	211	212	213	214	215	216	217	218	219	220
221	222	223	224	225	226	227	228	229	230	231	232	233	234	235	236	237	238	239	240
241	242	243	244	245	246	247	248	249	250	251	252	253	254	255	256	257	258	259	260
261	262	263	264	265	266	267	268	269	270	271	272	273	274	275	276	277	278	279	280
281	282	283	284	285	286	287	288	289	290	291	292	293	294	295	296	297	298	299	300
301	302	303	304	305	306	307	308	309	310	311	312	313	314	315	316	317	318	319	320
321	322	323	324	325	326	327	328	329	330	331	332	333	334	335	336	337	338	339	340
341	342	343	344	345	346	347	348	349	350	351	352	353	354	355	356	357	358	359	360
361	362	363	364	365	366	367	368	369	370	371	372	373	374	375	376	377	378	379	380
381	382	383	384	385	386	387	388	389	390	391	392	393	394	395	396	397	398	399	400
401	402	403	404	405	406	407	408	409	410	411	412	413	414	415	416	417	418	419	420
421	422	423	424	425	426	427	428	429	430	431	432	433	434	435	436	437	438	439	440
441	442	443	444	445	446	447	448	449	450	451	452	453	454	455	456	457	458	459	460
461	462	463	464	465	466	467	468	469	470	471	472	473	474	475	476	477	478	479	480
481	482	483	484	485	486	487	488	489	490	491	492	493	494	495	496	497	498	499	500
501	502	503	504	505	506	507	508	509	510	511	512	513	514	515	516	517	518	519	520
521	522	523	524	525	526	527	528	529	530	531	532	533	534	535	536	537	538	539	540
541	542	543	544	545	546	547	548	549	550	551	552	553	554	555	556	557	558	559	560
561	562	563	564	565	566	567	568	569	570	571	572	573	574	575	576	577	578	579	580
581	582	583	584	585	586	587	588	589	590	591	592	593	594	595	596	597	598	599	600

INSIDE FRONT COVER

INSIDE BACK COVER

BACK COVER



Some Advertisements which cannot be numbered for the READER SERVICE CARD due to lack of space, must be indicated by writing the Advertiser's name in the space provided at the bottom of the

card . . .



# YOU WILL RECEIVE 53 ISSUES IN 1958

alternate  
engineering  
and business  
editions  
plus . . .  
the  
buyers' guide

electronics  

A MCGRAW-HILL PUBLICATION  
370 WEST 42ND STREET, NEW YORK 36, N.Y.

## CHART OF PUBLISHING CYCLES

electronics engineering edition	electronics business edition	electronics engineering edition	electronics business edition
CYCLE A	CYCLE B	CYCLE C	CYCLE D
JAN. 3	JAN. 10	JAN. 17	JAN. 24
JAN. 31	FEB. 7	FEB. 14	FEB. 21
FEB. 28	MAR. 7	MAR. 14	MAR. 21
MAR. 28	APR. 4	APR. 11	APR. 18
APR. 25	MAY 2	MAY 9	MAY 16
MAY 23	MAY 30	JUNE 6	JUNE 13
JUNE 20	JUNE 27	JULY 4	JULY 11
JULY 18	JULY 25	AUG. 1	AUG. 8
AUG. 15	AUG. 22	AUG. 29	SEPT. 5
SEPT. 12	SEPT. 19	SEPT. 26	OCT. 3
OCT. 10	OCT. 17	OCT. 24	OCT. 31
NOV. 7	NOV. 14	NOV. 21	NOV. 28
DEC. 5	DEC. 12	DEC. 19	DEC. 26

**BUYERS' GUIDE ISSUE — JUNE 15**

FIRST CLASS  
PERMIT NO. 64  
(Sec. 34.9 P.L.&R.)  
NEW YORK, N. Y.

### BUSINESS REPLY CARD

NO POSTAGE STAMP NECESSARY IF MAILED IN THE UNITED STATES

4¢ Postage Will Be Paid By

**ELECTRONICS**

Reader Service Dept.  
330 West 42nd Street  
New York 36, N. Y.



# A DEPENDABLE SUPPLIER FOR 61 YEARS



A CTS control can be tailored to your specific requirement. Consult CTS SPECIALISTS on your current variable resistor problems. Ask for 62 page catalog.

*Variable resistors shown 2/3 actual size*

## WEST COAST MANUFACTURERS:

Many types of variable resistors now in production at our South Pasadena plant. Your coil, transformer and compression molding business also invited. Prompt delivery. Modern versatile equipment. L. A. phone Clinton 5-7186.

**Specialized Technical Skills—**  
1500 job-trained, class-trained specialists . . . with a world-wide reputation for delivering variable resistors exactly as specified.

**Tremendous Production Facilities—**  
323,000 sq. ft. plant devoted to variable resistors.

**Your changing Requirements Anticipated—**continuous research develops new materials, designs and methods to meet your new requirements.

**Economical Uniform Assembly—**on a precision mass production basis.

**Dependable Delivery—**exceptionally good delivery cycle.

**Complete Line—**variable resistors for military, color and black and white TV, radio, and other commercial applications.

WEST COAST SUBSIDIARY  
Chicago Telephone Supply  
California Inc.  
105 Pasadena Avenue  
South Pasadena, California  
L. A. Phone: Clinton 5-7186  
VX LA 1105

EAST COAST OFFICE  
130 N. Broadway  
Camden 2, New Jersey  
Phone: Woodlawn 6-1668  
TWX No. Camden NJ 380  
Phila. Phone: Market 7-3129

SOUTH AMERICA  
Jose Luis Pontet  
Buenos Aires, Argentina  
Montevideo, Uruguay  
Rio de Janeiro, Brazil  
Sao Paulo, Brazil

SOUTHWESTERN U.S.A.  
John A. Green Company  
137 Parkhouse  
Dallas 7, Texas  
Phone: Riverside 3266

OTHER EXPORT  
Sylvan Ginsbury  
8 West 40th Street  
New York 18, New York  
Phone: Pennsylvania 6-8239

CANADIAN SUBSIDIARY  
C. Meredith & Co., Ltd.  
Brampton, Ontario  
Phone: 319

FOUNDED



1896

CHICAGO TELEPHONE SUPPLY  
*Corporation*

ELKHART, INDIANA

*The Exclusive Specialists in Precision Mass Production of Variable Resistors*

for  
**HEARING  
AIDS**



or  
**RECORDING  
HEADS**



or ANY MAGNETIC MATERIALS JOB...

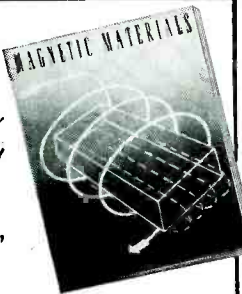

*Write for  
your Copy*

**"MAGNETIC  
MATERIALS"**

This 32-page book contains valuable data on all Allegheny Ludlum magnetic materials, silicon steels and special electrical alloys. Illustrated in full color, includes essential information on properties, characteristics, applications, etc. Your copy gladly sent free.

**ADDRESS DEPT. E-96**

You can rely on core materials like the Allegheny 4750 components illustrated above, in your receivers, recording heads or microphone assemblies.

In fact, whether your equipment is small or large, the extra-broad line of A-L magnetic materials will solve your magnetic core problems. It includes all grades of silicon steel sheets or coil strip, as well as Allegheny Silectron (grain-oriented silicon steel), and a wide selection of high-permea-

bility alloys such as 4750, Mumetal, Permendur, etc.

Our service on these materials also includes complete facilities for the fabrication and heat treatment of laminations. (For users of electrical sheets and strip, our lamination know-how is a real bonus value!) Either way, we'll welcome the chance to serve you. *Allegheny Ludlum Steel Corporation, Oliver Building, Pittsburgh 22, Pa.*

**STEELMAKERS** to the Electrical Industry

**Allegheny Ludlum**



W&D 5335

# For the record... it's **IMMEDIATE-PRINT** scope photos with the **DUMONT® 302**

- NOW, ULTRA-FAST TRANSPARENT POLAROID-LAND FILM FOR HIGH SPEED RECORDING!
- CONTACT AND PROJECTION PRINTS... NO IMAGE REVERSAL.
- EASY, INEXPENSIVE CONVERSION TO VARIETY OF STANDARD ROLL AND CUT FILMS.
- CLICK-STOP SLIDE PERMITS MULTIPLE EXPOSURES ON SINGLE FRAME FOR GREATER FILM ECONOMY AND EASY, DIRECT WAVEFORM COMPARISON.
- FULL BINOCULAR VIEWING SIMULTANEOUS WITH RECORDING.
- MOUNTS QUICKLY AND EASILY ON ANY STANDARD 5" SCOPE. NO ADDITIONAL SUPPORTS REQUIRED.
- EASY ACCESS FOR LENS AND SHUTTER ADJUSTMENT.
- BUILT-IN DATA RECORDING SYSTEM.



The Du Mont Type 302 Recording Camera provides the most convenient and flexible means for applying the many advantages of the immediate-print Polaroid-Land process to oscilloscope recording.

And now the utility of the Polaroid-Land process has been greatly extended with the development of the new Polaroid-Land projection film — a transparent base material with a specified emulsion speed of 1000 (ASA).

This new film not only permits contact and projection prints, and eliminates image reversal, but also enables use of the Polaroid-Land process in recording ultra-high-speed phenomena — even single transients.

Utility of the 302 is further broadened by the availability of adapter backs which permit the camera to use various standard roll and cut films. Write for full information...

## SPECIFICATIONS

- Wollensak-Du Mont 75 mm f/2.8 three element lens, or 75 mm f/1.9 six element lens.
- Image reduction ratio 2.25:1.
- Alphax #2 shutter, bulb and 1/25 to 1/100 sec. with f/2.8 lens. Alphax #3 shutter, time, bulb and 1 sec. with f/1.9 lens.
- Writing rate dependent upon film used.
- Mounting clamp for use on any standard 5" scope bezel.

Type 302 with f/2.8 lens \$314.00  
Type 302 with f/1.9 lens 391.00

## WHATEVER YOUR REQUIREMENTS... DUMONT HAS THE CAMERA



### TYPE 352

High-speed, single frame 35 mm featuring automatic film advance. 8 frames/sec. automatically. Wollensak f/1.5 lens. \$648.00



### TYPE 339

Immediate-print type utilizing Polaroid film. Special f/2.8 lens for distortion-free images. Binocular viewing of screen. \$246.00



### TYPE 299

General-purpose camera accepting backs for roll-film, film-pack, or cut film. Converts to Type 302 for Polaroid recording. f/1.9 lens \$369.00, f/2.8 lens \$292.00



### TYPE 296

Low-cost, general-purpose single-frame camera. Uses standard cassette wound 35 mm film. Corrected f/2.8 lens. Viewing port. \$164.50



### TYPE 321-A

Permits either continuous or single-frame recording. Perforated or unperforated film or paper in 100 or 400 foot reels. Variable film drive speeds from 0.8 to 10,800 in./min. 321-A with f/1.5 lens \$1270.00, 321-A with f/2.8 lens \$1120.00. (50 cps models available)

# DUMONT®

WRITE FOR COMPLETE DETAILS...

TECHNICAL SALES DEPARTMENT, ALLEN B. DUMONT LABORATORIES, INC.  
CLIFTON, NEW JERSEY

# Insulate... Hold... Protect

REG. U. S. PAT. OFF.  
**with SCOTCH Electrical Products!**  
BRAND

CONSIDER THE VARIETY: "SCOTCH" Brand Electrical Products come in many forms... each planned to do a specific job better, easier, more dependably:

"SCOTCH" Brand Pressure-Sensitive Tapes (they stick at a touch!) insulate... strengthen... pad... hold... identify. There are thermosetting tapes for maximum adhesion and varnish resistance... tapes with temperature performance ranges from Class O to Class H... tapes that offer dielectric strengths up to 19,000 V... others to fill space requirements down to .002" *thin*. There are rigid and flexible epoxy resins for embedment, encapsulation, and dipping.

DEPEND ON THE QUALITY: All "SCOTCH" Brand Electrical Products are designed and formulated with valuable non-corrosive features in 3M's own laboratories—America's most progressive electrical insulation laboratories. Constant quality control assures you that when you design with "SCOTCH" Brand in mind, the product functions the way you want it to.

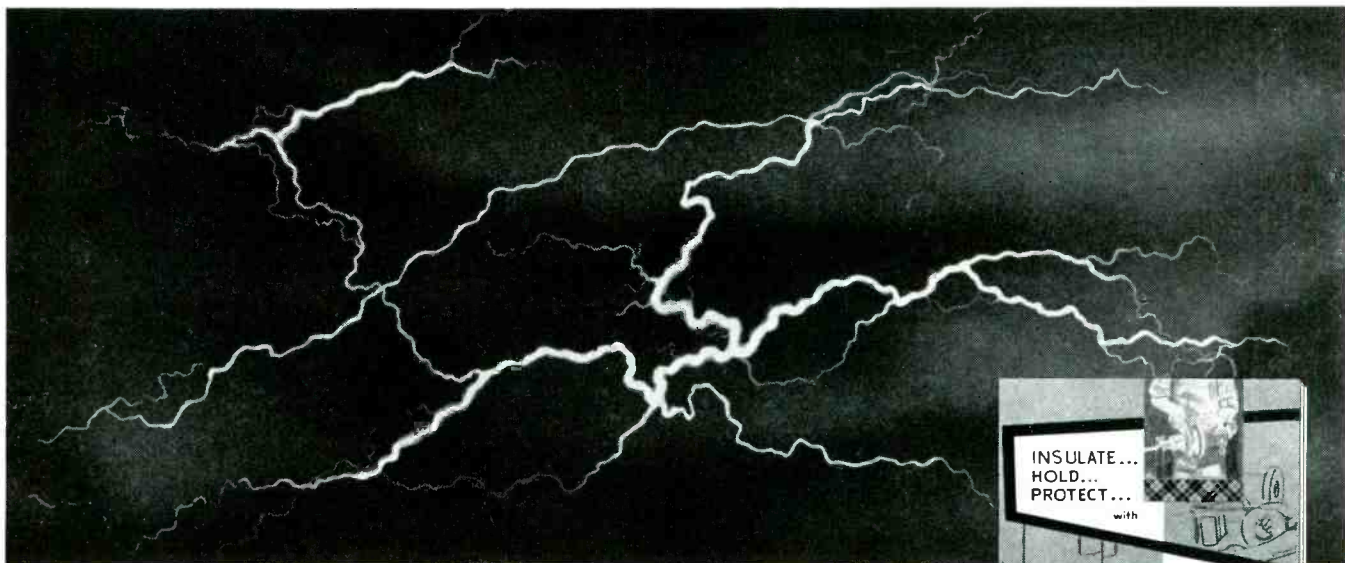

WANT TECHNICAL ADVICE? Ask for a 3M Sales Representative to call. He is trained and experienced to assist you in developing and planning your insulation requirements. Send for free catalog of "SCOTCH" Brand Electrical Products with performance characteristics and specification data. Just write on your letterhead to 3M Company, 900 Bush Avenue, St. Paul 6, Minn., Dept. CA-127.

REG. U. S. PAT. OFF.  
**SCOTCH Electrical Products**  
BRAND

The term "SCOTCH" is a registered trademark of Minnesota Mining and Manufacturing Company, St. Paul 6, Minn.  
Export Sales Office: 99 Park Ave., New York 16, N.Y. In Canada: P.O. Box 757, London, Ontario.





**WHEN IT  
COMES TO  
MINIATURE  
CONTROLS...**

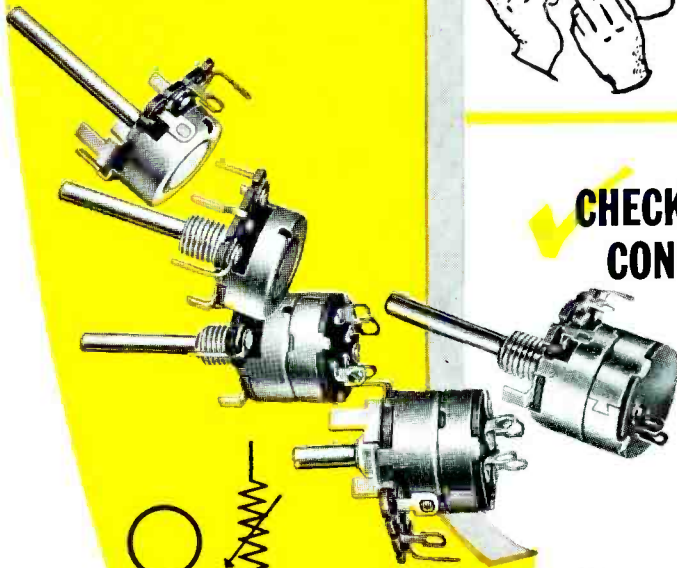

**STACKPOLE**  
miniature "F"-series  
**VARIABLE RESISTORS**

**CHECK THE OVERALL SIZE...**

including switch, if needed. For practical space-saving ability, Stackpole miniature "F" Controls lead the way — only 0.637" in diameter behind the panel for the entire length of *both* control and switch.

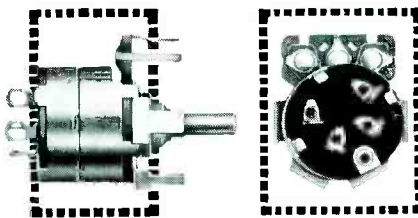

Photos show side and rear views of a Stackpole F Control with 2-pole switch. Dotted lines indicate behind-panel space occupied by a conventional "miniature" control.

Notice how Stackpole's small switch size perfectly complements the miniature control . . . saves precious chassis space where it's needed the most.

**FEEL and HEAR THE SWITCH ACTION...**



for the tease-proof, positive "feel" and audible "click" only a true snap-action switch provides. "B"-Series switches used on "F" Controls have the same time-proven mechanism as larger Stackpole control switches. They're U.L. Inspected for 1 amp. @ 125v ac-dc; 4 amps @ 25v dc.

**CHECK THE COMPLETENESS OF BOTH  
CONTROL and SWITCH LINES**

Printed wiring, wire-wrap, or standard lug terminals as well as fold-tab or threaded bushing mountings are available on all Stackpole miniature "F" controls. *Both* SPST and DPST switches can be supplied.

*Electronic Components Division*

**STACKPOLE CARBON COMPANY, St. Marys, Pa.**

*In Canada: Canadian Stackpole Ltd., 550 Evans Ave., Etobicoke, Toronto 14, Ont.*

FIXED & VARIABLE COMPOSITION RESISTORS • SLIDE & SNAP SWITCHES • IRON CORES • CERAMIC MAGNETS  
FIXED COMPOSITION CAPACITORS • CERAMAG® FERROMAGNETIC CORES  
HUNDREDS OF CARBON, GRAPHITE, AND METAL POWDER PRODUCTS.

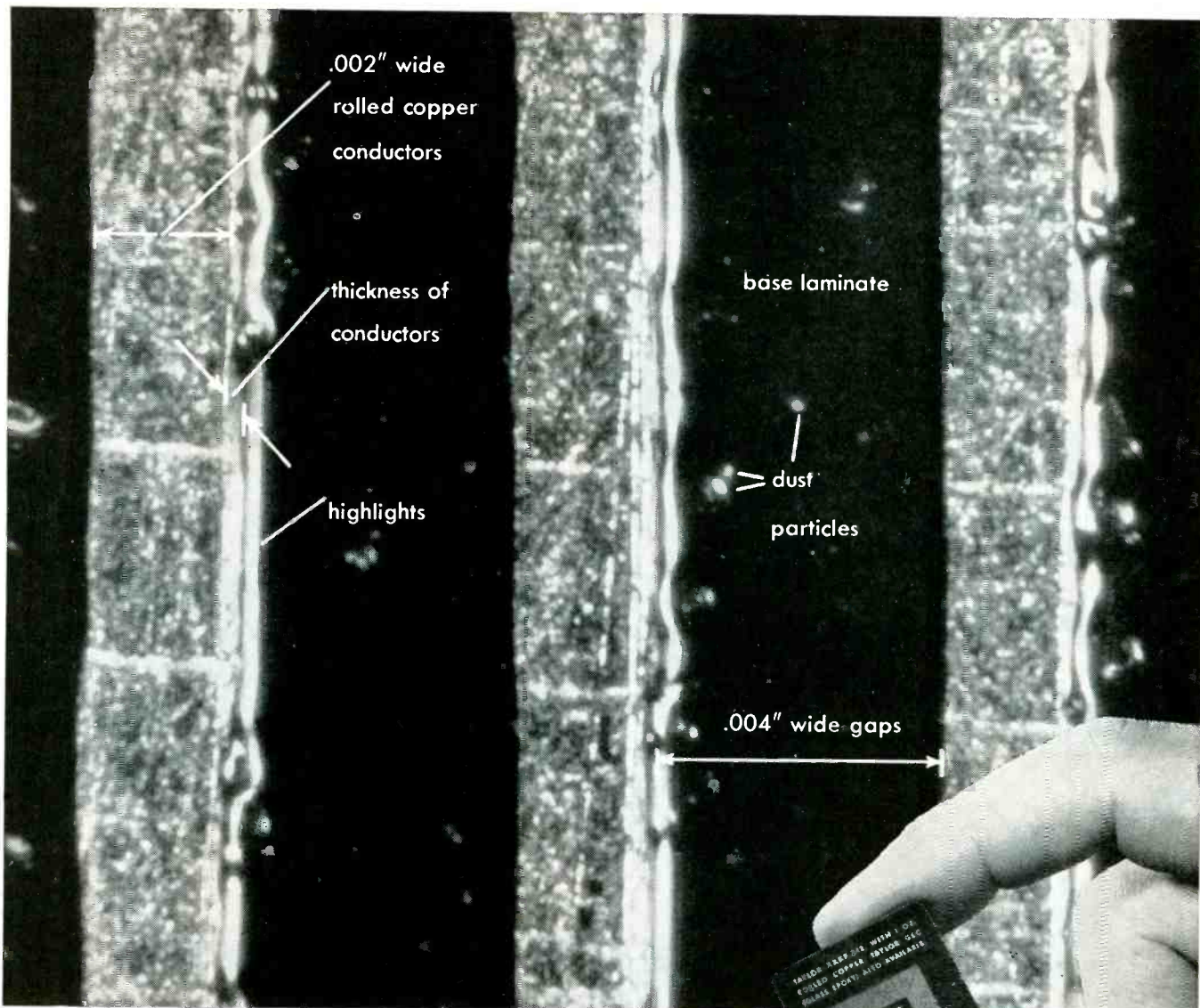

## Here's Fine Line Etching ... 375 Times Enlarged!

This is what Taylor means by *better printed circuits* . . . the unretouched photograph above is an enlargement of the miniature etched test coil shown at right. Here is a dramatic illustration of exactly what Taylor means by saying rolled copper-clad laminates give you *better printed circuits*. Enlarged 375 times, this photograph shows how the .002" wide conductors are parallel and free of pits, pinholes and lead inclusions.

Here's proof of why you'll be satisfied with your printed circuits . . . if they're made with Taylor copper-clad laminates. You're assured of a uniform material, offering consistently satisfactory etching . . . better production rates.

For more detailed information on Taylor copper-clad laminates . . . for a discussion on how these laminates can help you produce *better printed circuits* . . . contact your nearest Taylor sales office.

Actual Size



TAYLOR FIBRE CO., PLANTS IN NORRISTOWN, PA. AND LA VERNE, CALIFORNIA

INTEGRATED MANUFACTURER & FABRICATOR OF  
Phenolic—Melamine—Silicone—Epoxy—Copper-Clad and  
Combination Laminates • Vulcanized Fibre

**TAYLOR**  
Laminated Plastics  
Vulcanized Fibre

FIRST AND LARGEST PRODUCER OF ROLLED COPPER-CLAD LAMINATES FOR BETTER PRINTED CIRCUITS

CIRCLE 6 READERS SERVICE CARD

December 1, 1957 — ELECTRONICS

# BRAND MULTI- CONDUCTOR CABLE GIVES RCA'S BIZMAC SYSTEMS...

- top signal fidelity
- freedom from cross talk

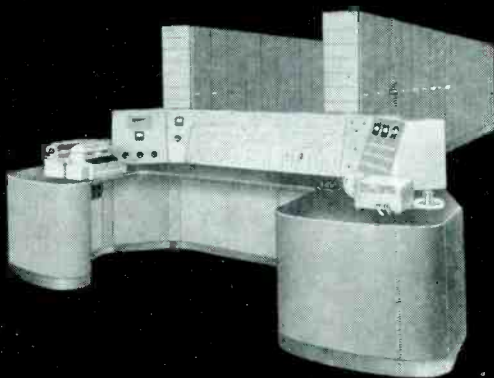

RCA'S Bizmac Business System Units combine to perform foolproof results in business efficiency. Connecting these units are three extremely flexible, abrasion resistant, Turbo-Brand multi-conductor cables, custom manufactured for RCA.

RCA says, "Brand cables transmit signals between our Bizmac units with high fidelity and without disrupting cross talk between signal lines."

One Brand cable (a) transmits a five micro-second pulse "write signal." Low impedance drive allows transmission of signals through 400 feet of balanced lines. The cable has nine twisted pairs of AWG 22 color coded conductors. The shielding of #36 tinned copper wires is braided over the conductor assembly. The over-all jacket is of .030" brown plastic. Another cable (b) transmits "tape control" signals which have a five micro-second pulse with about a three micro-second rise time across the conductors. Each of the 12 pairs of conductors are shielded with a #36 tinned soft copper braid, and the over-all jacket is of .030" red polyvinyl chloride. The other cable (c) transmits "read signals" that resemble a full sine wave whose period is 70 micro-seconds. The 12 twisted pairs of AWG 22 conductors have a tinned copper over-all shielding braided over the conductor assembly. The over-all jacket is of .030" black vinyl plastic.

The accumulated experience of the William Brand & Co., Incorporated Engineering, Research and Production Departments is always available. You are invited to use these services in the solution of any of your wire and/or cable problems.



## THE WILLIAM BRAND & CO., INCORPORATED

WILLIMANTIC 3



CONNECTICUT

electrical and electronic wires and cables • harnesses and cable assemblies • plastic and coated insulating tubings • identification markers

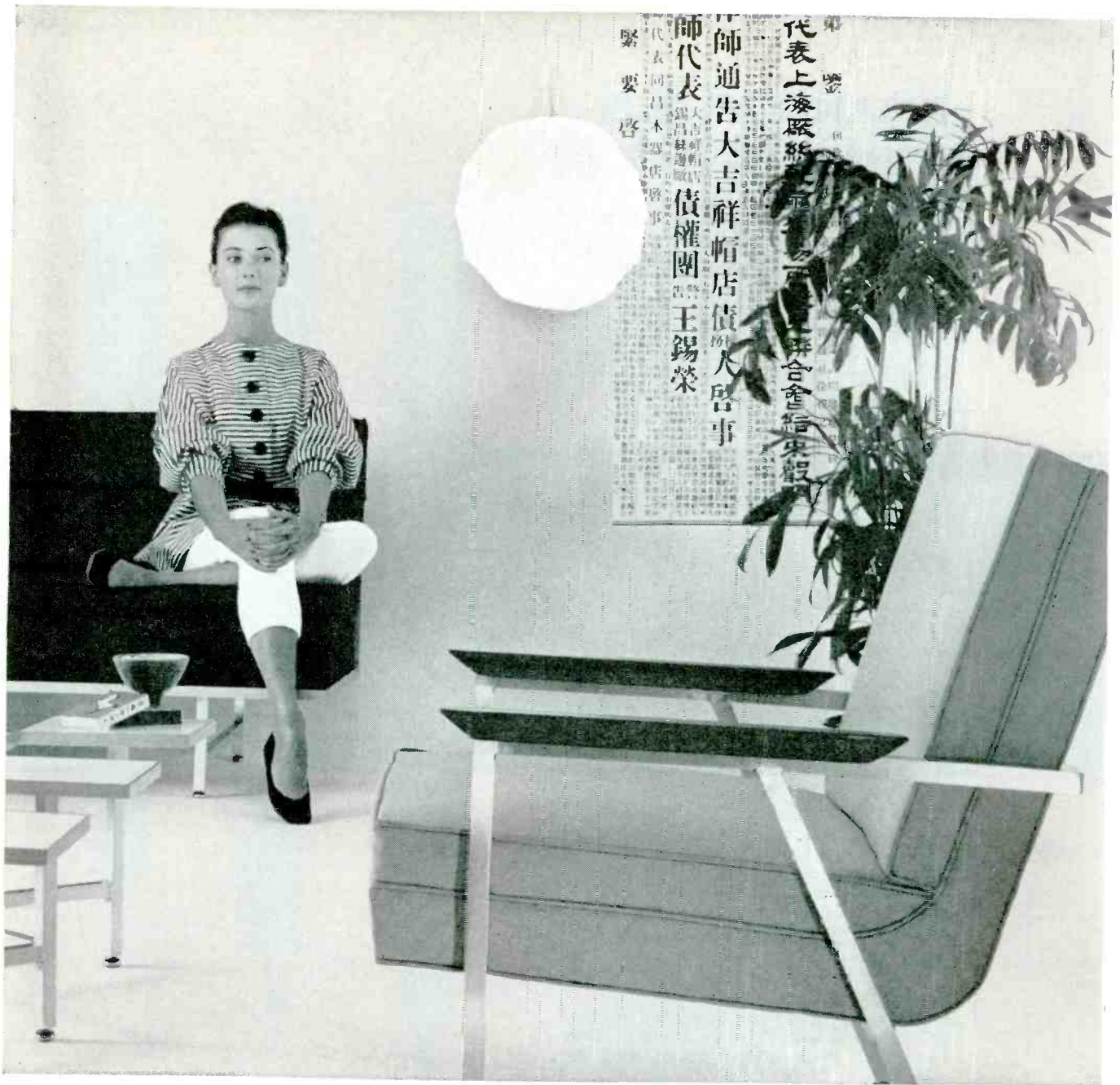

## Variety—you can choose from a wide range of finishes for magnesium

Smart, modern furniture is just one example of how finishes for magnesium are widening design horizons. Whether for appearance, protection, or a combination of both, the right finish is available. Magnesium can be painted, chemically treated, electroplated, and coated with plastic or rubber.

To meet the rigorous standards set by the aircraft industry, there are air dried and baked paint finishes with excellent adhesion, maximum imperviousness and good wear resistance. Various types of chemical pickling provide the right

paint base. Anodizing provides exceptional corrosion, heat and abrasion resistance. In addition, any metal which can be applied by electroplating may be deposited on magnesium.

What about your products? If you're not making use of magnesium lightness, strength and durability—and the variety of finishes for magnesium—there's no better time to start than right now. Contact your nearest Dow sales office or write to us for more information. THE DOW CHEMICAL COMPANY, Midland, Michigan, Department MA 1405M.

YOU CAN DEPEND ON

**DOW**



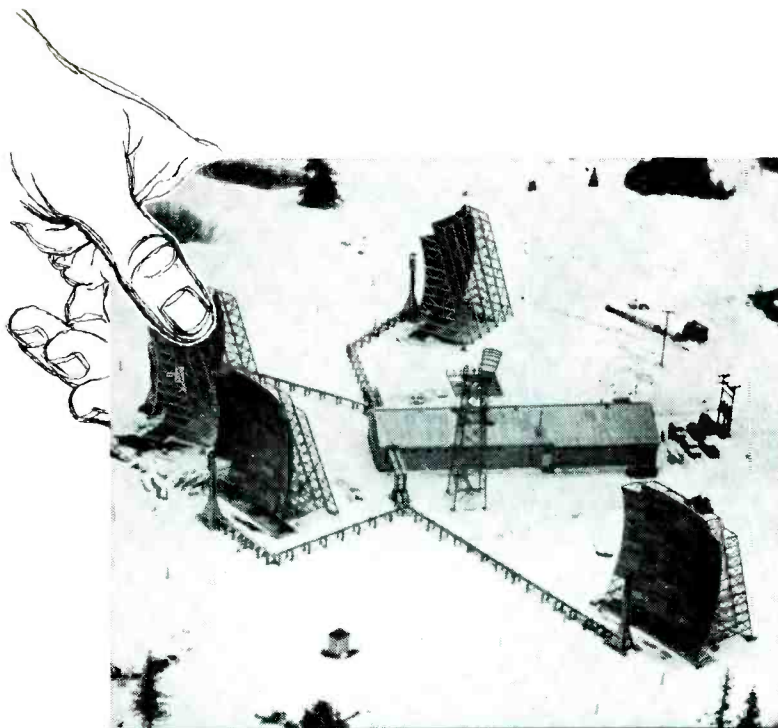

Photo: Western Electric Co., Inc.

## TOP NAME IN TROPO SCATTER

Detailed information and technical data on the tropospheric scatter radio equipment for four major projects has recently been published by REL.

Entitled *Top name in tropo scatter*, this manual describes the radio apparatus developed and manufactured by REL for the first major project, Polevault; for the largest, White Alice; for AN/FRC-39; and for the Texas Towers, AN/FRC-56.

If you have a specialized interest in this field, a free copy is yours for the asking from REL, world leader in tropo scatter equipment.

*Creative careers at REL await a few exceptional engineers. Address resumes to James W. Kelly, Personnel Director.*

## Radio Engineering Laboratories-Inc.

*A subsidiary of Dynamics Corporation of America*

**29-01 Borden Ave • Long Island City 1, NY**

STillwell 6-2100 • Teletype: NY 4-2816

Canadian representative: AHEARN & SOPER CO • 384 BANK ST • OTTAWA



*Behind the quality of Phelps Dodge* **FORMVAR...**

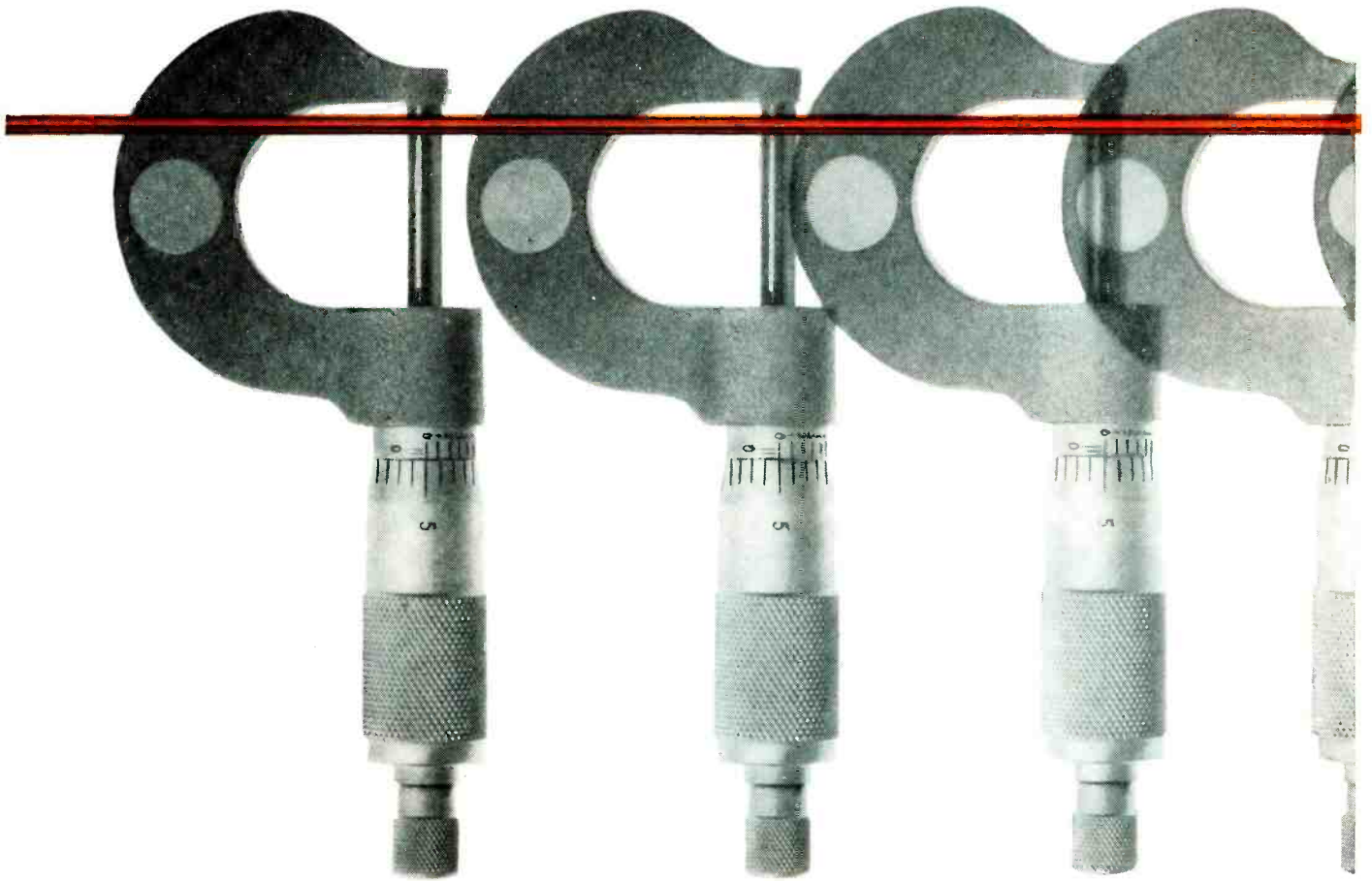

## **CAREFUL CONTROL OF FINELY**

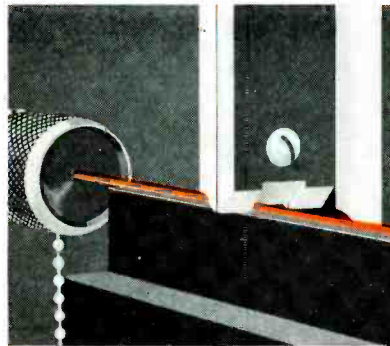

Abrasion resistance



Film flexibility

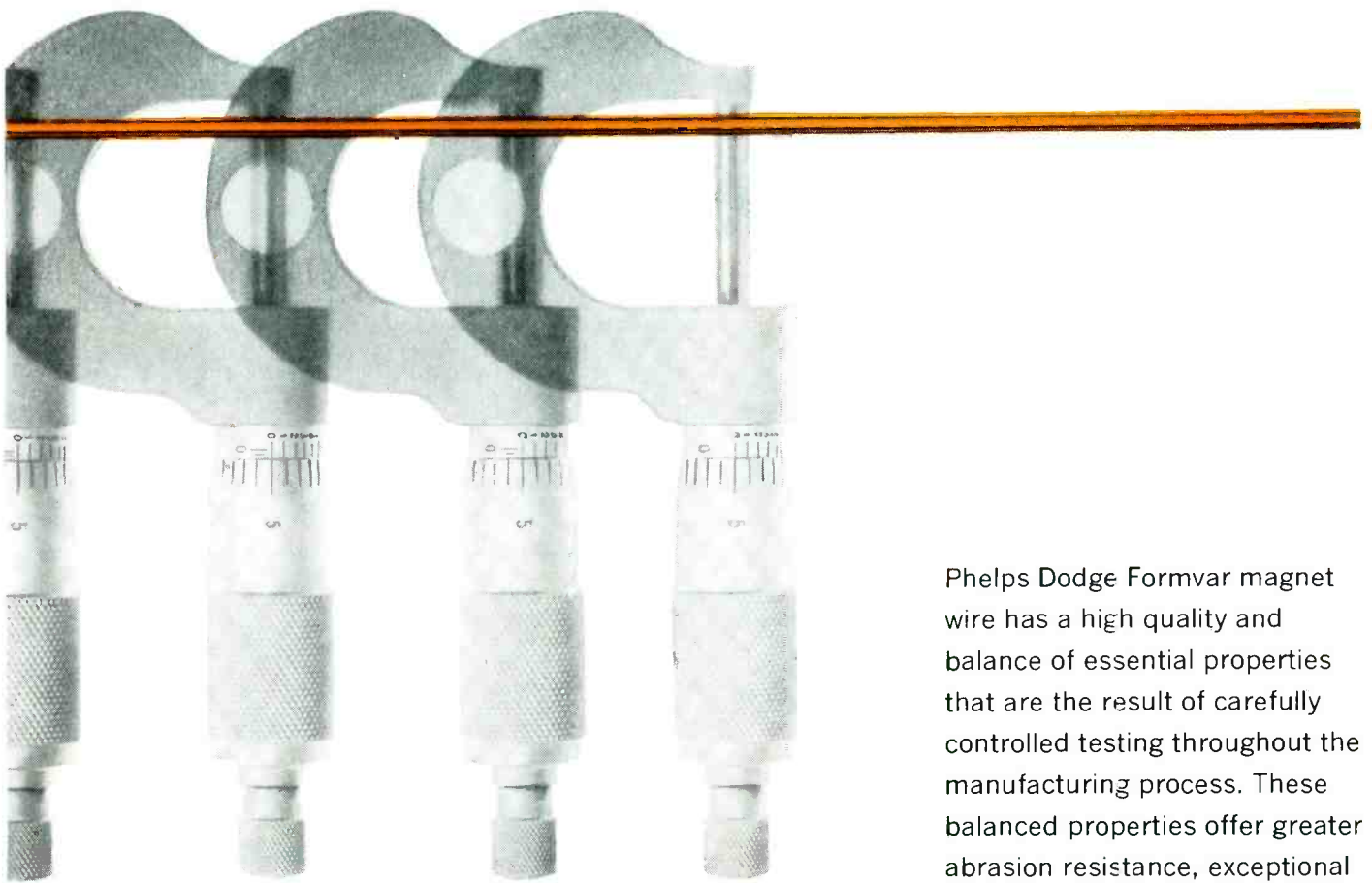

Phelps Dodge Formvar magnet wire has a high quality and balance of essential properties that are the result of carefully controlled testing throughout the manufacturing process. These balanced properties offer greater abrasion resistance, exceptional film flexibility, improved solvent resistance and high product uniformity—factors that serve to make Phelps Dodge Formvar the standard “yardstick” for the electrical equipment industry. Phelps Dodge Formvar is available in round, square and rectangular shapes.

## BALANCED PROPERTIES

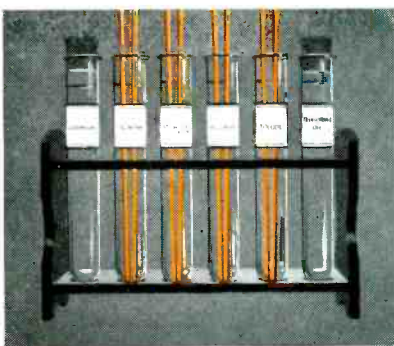

Solvent resistance

*Any time magnet wire is your problem, consult Phelps Dodge for the quickest, easiest answer!*

**PHELPS DODGE COPPER PRODUCTS CORPORATION**

**INCA MANUFACTURING DIVISION**

FORT WAYNE, INDIANA



FIRST FOR  
LASTING QUALITY  
—FROM MINE  
TO MARKET!



**For Contacts  
Which Don't Exist  
Look to  
GENERAL PLATE**

Paradoxical statement? Not at all — it's merely another way of saying that at G.P. you're not limited to yesterday's thinking in solving tomorrow's contact problems.

For beyond the tremendous variety of contacts already in production at G.P., are the know-how of G.P. engineers and the versatility of G.P. clad metals which combine to offer you better contact performance at lower cost.

Here are a few examples of new contact ideas which are now in commercial use at G.P.

**Clad Electrical Contact Tapes** — designed for high speed mechanized assembly — ideal for miniaturization — give increased performance at reduced cost.

**New Metal Bonding Processes** — offer improved contact materials — include silver cadmium oxides, refractory metal mixtures and platinum group metals, as well as all regular silver materials.

**New Clad Button Projection** — designed and produced to meet your specific application requirements — facilitate easier welding, provide better conductivity.

**Single and Double Inlay-Overlay-Top-Lay** — made by G.P.'s new exclusive P.T. cladding process — achieves permanent bonding of preferred contact metals to practically any malleable base metal without intermediate bonding agents.

**Trimetal Clad Projection Welding Contacts** — a copper conductor between contact face and backing — provides higher specific heat with lower surface temperatures — gives greater contact capacity and longer life at lower cost.

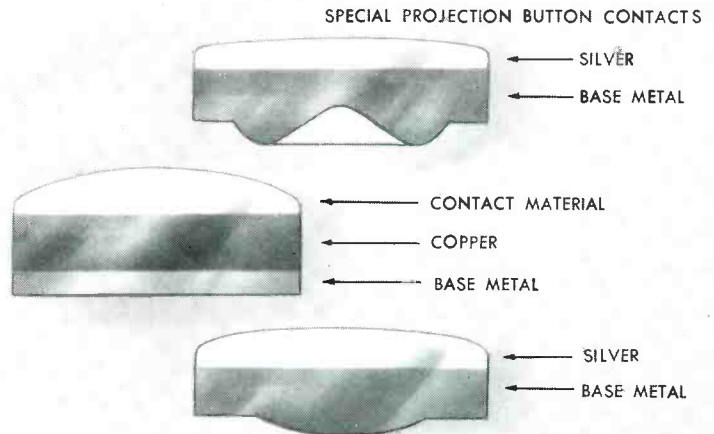
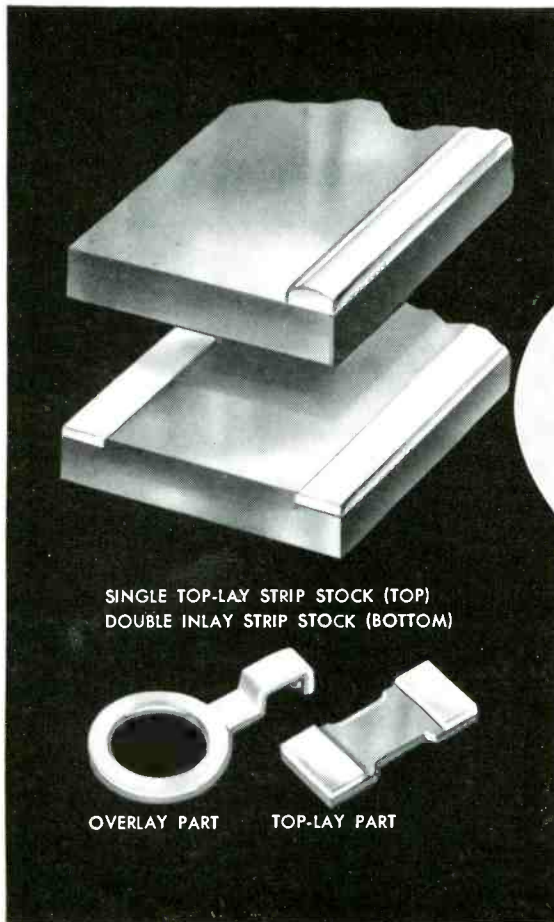

With 41 years of General Plate metal cladding experience behind the emphasis now being put on G.P. electrical contacts, it will pay you to investigate. Technical data bulletins are available on request — just let us know what types of contacts you are interested in.

**METALS & CONTROLS CORPORATION**

General Plate Division 1312 Forest Street, Attleboro, Mass.

FIELD OFFICES: NEW YORK. CHICAGO, DETROIT. MILWAUKEE. LOS ANGELES

You can profit by using General Plate clad metals.

# Transitron

# Silicon Transistors

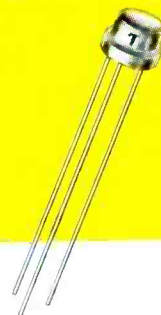

ACTUAL SIZE

## Features . . .

- Low  $I_{CO}$ , typically under .02  $\mu$ a
- Operation to 175°C
- 200 mw Power Rating
- High Frequency Operation
- High Temperature Tested
- Excellent Stability
- Welded Hermetic Seal

## ... for high temperature operation

Transitron's NPN silicon transistors are designed for a wide range of small signal applications in the power range up to 200 mw. They will provide dependable operation up to 175°C in circuits such as RF and IF amplifiers, video and audio amplifiers, servo control, switching, and many others.

Manufactured by diffusion in the liquid phase during crystal growth, these transistors are essentially free of parameter drift and instability common in conventional grown junction transistors. Through close process control, these units have exceptionally low  $I_{CO}$  up to their maximum voltage and temperature ratings. As a result, performance reliability can be achieved even at higher voltage levels.

For environmental stability, extensive temperature cycling and storage as well as mechanical and hermetic seal tests are included as a regular part of the manufacturing process.

Type	Minimum Common Emitter Current Gain, B	Maximum Collector Voltage $V_{CE}$ Peak (volts)	Typical Cut-off Frequency (mc)	Maximum Collector Cut-Off Current at 25°C at $V_{CE}$ Max. ( $\mu$ a)
ST42	40	45	11	.5
ST32	40	30	11	.5
ST12	40	15	11	.5
ST33	30	30	17	.5
ST13	30	15	17	.5
ST41	20	45	10	.5
ST31	20	30	10	.5
ST11	20	15	10	.5
2N332	9	45	7	50
2N333	18	45	9	50
2N334	18	45	11	50
2N335	37	45	10	50

Send for  
Bulletin TE-1353

# Transitron

electronic corporation • wakefield, massachusetts



Transistors



Diodes



Regulators



Rectifiers



## A versatile DC supply for men who design or test electrical and electronic equipment prototypes

Do you design or test "prototypes?" If so, and you're seeking a laboratory source of high-current DC voltage, it will pay you to use the "DC Solavolt." It's a moderately-priced, adjustable, regulated dc power supply that provides unusual stability with intermittent, variable, or pulse loads. Output voltage is regulated to within  $\pm 1\%$  though supply voltage may vary as much as  $\pm 10\%$ . Ripple is held to 0.1% or less.

Electrical specifications of the six stock "DC Solavolts" available appear in the table below:

All Inputs 100-130 volts, 60 cps

Catalog Number of Stock Units	Regulated Adjustable Output Voltage Range	Rated Loadings in Amperes		Ripple* Voltage—% of Total Output
		At max. Voltage Setting	At min. Voltage Setting	
28510	5-35	7.0	7.0	0.10
28520	25-60	4.0	6.0	0.05
28530	30-90	2.8	4.0	0.04
28540	60-180	1.4	2.0	0.03
28550	150-250	1.0	1.5	0.02
28560	250-400	0.6	0.75	0.02

\*Figures in this column cover ripple voltages measured at full rated load and input of 115 volts.

Along with these laboratory standards of performance, the DC Solavolt offers compactness, low weight, high efficiency, and high short-time overload capacity. All stock models occupy only 7" of height and 12 $\frac{1}{4}$ " of depth on a standard 19" relay rack frame. There are no tubes to replace, no compensating adjustments are needed, and no maintenance is required. Carrying handles, available as accessory equipment, provide "one-man" portability and self-stacking. Your local electronic distributor, who stocks the DC Solavolt, will be happy to give you further information.

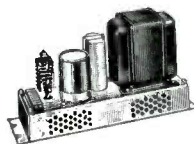

Write for Bulletin  
SOLA ELECTRIC CO.  
4633 W. 16th Street, Chicago 50

**SOLA** *Constant Voltage*  
**DC POWER SUPPLIES**

CONSTANT VOLTAGE TRANSFORMERS • LIGHTING TRANSFORMERS • CONSTANT VOLTAGE DC POWER SUPPLIES  
SOLA ELECTRIC CO., 4633 West 16th Street, Chicago 50, Illinois, Bishop 2-1414 • BRANCH OFFICES: Boston, Mass.; Cleveland, Ohio; Kansas City, Mo.; Los Angeles, Calif.; New York, N. Y.; Philadelphia, Pa.; San Francisco, Calif.; Wallingford, Conn. • Representatives in Other Principal Cities  
Sola Electric (Canada) Ltd., Toronto 17, Ontario; 102 Laird Drive, Mayfair 4554



# TIP-N-DIP

Now . . . printed circuit component mounting  
**SECURELY — RAPIDLY**

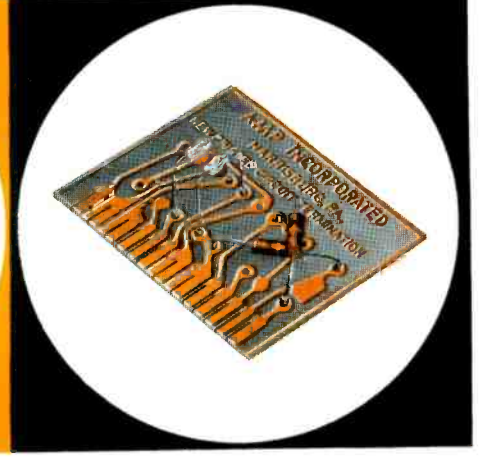
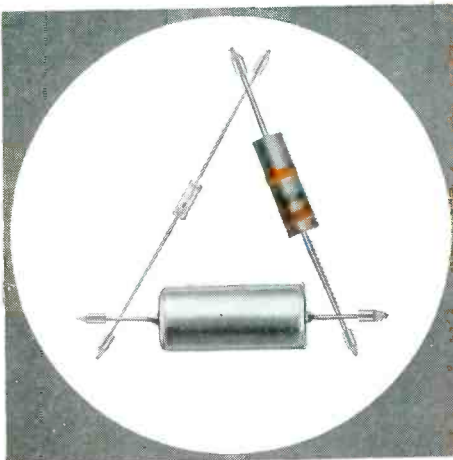

**The A-MP Component Tip provides these new advantages to manufacturers using printed circuit techniques:**

- eliminates the need for eyelets or thru-plating on two-sided boards
- prevents cold solder problems by eliminating any movement of the component during dipping cycle
- permits bridging or offsetting of components—for air circulation and elimination of temperature influence
- design promotes solder-wicking and uniform solder deposit
- protects fine semi-conductor leads from heat and assembly damage

AMP-engineered, high-speed, automatic tipping machines provide an easy and economical method for applying A-MP Component Tips to leads of single-piece or belted components.

**Additional Information is available on request.**

## AMP INCORPORATED

**GENERAL OFFICES:**

**3340 Eisenhower Boulevard, Harrisburg, Pa.**

Wholly Owned Subsidiaries: Aircraft-Marine Products of Canada Ltd., Toronto, Canada  
 Aircraft-Marine Products (Great Britain) Ltd., London, England • Societe AMP de  
 France, Le Pre St. Gervais, Seine, France • AMP-Holland N. V.'s-Hertogenbosch, Holland  
 Distributor in Japan: Oriental Terminal Products Co., Ltd., Tokyo, Japan



# NEW!

The color film that changed the standards of still photographers everywhere is now available as a 16mm motion picture stock.

# SUPER ANSCOCHROME 16mm FILM

## Daylight-exposure index 100

● This premium color emulsion, widely accepted and acclaimed in still work, has been made available in 16mm width for motion picture photography. Its speed of 100 makes it the most useful film for all phases of industrial cinematography where speed and superb color renditions are called for. Super Anscochrome's improved curve conformity, characteristic of all Anscochrome emulsions, provides a color balance that has never been achieved in any other color film. It combines high speed, good latitude, clean highlights and superior shadow area penetration—all so desirable for high speed motion analysis, stress studies and data recording as well as routine work where a reserve of speed is needed. And, Super Anscochrome's high speed does *not* mean a loss of quality. Its design is such that the speed becomes an added feature to the already outstanding characteristics of Anscochrome emulsions.

Also available in 35mm and 70mm. *Ansco, Binghamton, New York.*  
*A Division of General Aniline and Film Corporation.*

**AnSCO**

*Super Anscochrome  
16 mm Film*





Model ESG

# All Electronic MICROWAVE SWEEP GENERATOR

- Dynamic Measurements, Rapidly
  - High Power Source
- ## 1,000 to 15,000 mc

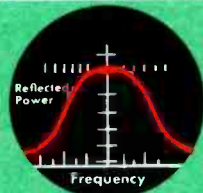
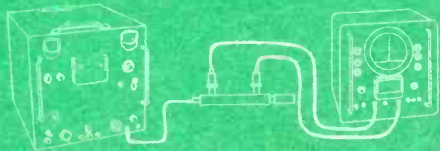

### MEASUREMENT OF VSWR OR PERCENT POWER REFLECTION

By employing an ESG along with a Rapid Scan Ratio-Scope (Model VS-1) in a reflectometer system set-up, accuracies equivalent to those obtained with the use of a slotted line can be achieved, by an untrained technician, in a fraction of the time formerly required. A two-to-one frequency range is provided. 7 interchangeable microwave oscillator units enable measurements to be made at microwave frequencies of 1000 to 15,000 mc.

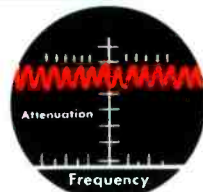
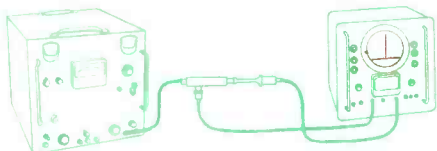

### ATTENUATION MEASUREMENT

Broadband attenuation measurements are easily made with an ESG and Rapid Scan Ratio-Scope (Model VS-1). Attenuation of the unit under test is read directly on the ratio-scope indicator. Attenuation measurements can be made either at single frequency or over a band of frequencies (ESG sweeps its full frequency range).

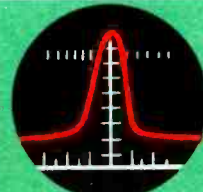
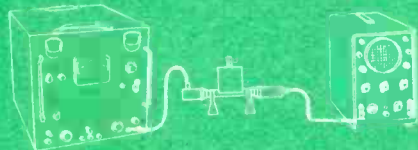

### MEASUREMENTS OF Q

The use of a Model ESG enables rapid visual instantaneous measurement of high and low Q. This cuts down engineering man hours when compared with laborious point-to-point Q measurements. The diagram shows a typical set-up utilizing a standard oscilloscope.

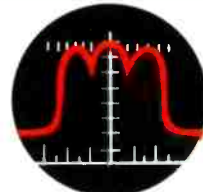
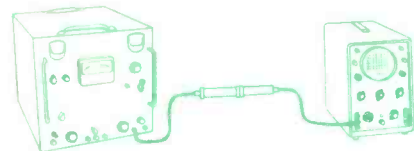

### FILTER ALIGNMENT AND BANDPASS MEASUREMENTS

Because of the ESG's rapid sweep, the complete characteristics of a filter can be observed and measured instantaneously, utilizing a standard oscilloscope. The ESG's high power output enables determination of the filter's offband response. Dynamic measurements across the entire frequency range of the filters are possible because the stable backward wave oscillator in the ESG sweeps the full frequency range of the filter.

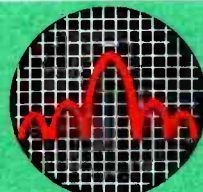

### ANTENNA PATTERN MEASUREMENTS

By using an ESG to feed an antenna under test, accurate pattern measurements can be obtained over long distances and over a wide frequency range. This because of the ESG's high stable power output from 10 milliwatts to 1 watt. Provision is made in the instrument for amplitude modulation from external source and internal 1000 cps and 456 kc square wave modulation is provided.



## POLARAD ELECTRONICS CORPORATION

43-20 34th Street, Long Island City 1, New York

REPRESENTATIVES: Abington, Albany, Atlanta, Baltimore, Boeing Field, Chicago, Cleveland, Dayton, Denver, Detroit, Englewood, Fort Worth, Kansas City, Los Angeles, Orlando, Portland, Rochester, St. Louis, Stamford, Sunnyvale, Syracuse, Washington, D.C., Westbury, Westwood, Wichita, Winston-Salem, Canada: Arnprior, Ontario. Resident Representatives in Principal Foreign Cities.

Polarad Model ESG Microwave Sweep Generator utilizes stable backward wave oscillators to make possible rapid dynamic tests of broadband and narrowband microwave systems and components. This instrument covers the frequency range from 1000 to 15,000 mc by use of 7 interchangeable microwave oscillator units, each of which can be purchased separately. The ESG can be externally modulated, providing a pulse rise time less than 0.15 microsecond.

Contact Polarad or your nearest Polarad representative for complete details. Polarad Model VS-1 Rapid Scan Ratio-Scope is available to provide visual presentation of VSWR and attenuation.

### SPECIFICATIONS: Basic Unit: Model E-B

INTERCHANGEABLE PLUG-IN UNITS					
MODEL	FREQUENCY RANGE	POWER OUTPUT	MODEL	FREQUENCY RANGE	POWER OUTPUT
Model E-L1	1,000 to 2,000 mc	80 to 1,000 mw	Model E-C2	4,800 to 9,600 mc	20 to 150 mw
Model E-L2	1,600 to 3,200 mc	80 to 1,000 mw	Model E-X1	6,500 to 11,000 mc	20 to 100 mw
Model E-S1	2,000 to 4,000 mc	80 to 800 mw	Model E-X2	7,500 to 15,000 mc	15 to 40 mw
Model E-C1	3,600 to 7,200 mc	25 to 400 mw			

# CODE MODULATED MULTIPLE-PULSE MICROWAVE SIGNAL GENERATOR 950-10,750 mc

*An integrated mobile instrument. Generates multi-pulse modulated carrier for missiles, beacons, radar, DME, Tacan, Loran... provides 5 independently adjustable pulse channels. Variable pulse width, delay and repetition rate; and pulse time modulation.*

## SPECIFICATIONS:

### Frequency Range:

- Band 1: 950 to 2400 mc.
- Band 2: 2150 to 4600 mc.
- Band 3: 4450 to 8000 mc
- Band 4: 7850 to 10,750 mc

### Frequency Accuracy: $\pm 1\%$

RF Power Output: 1 milliwatt (0 DBM)

### Attenuator:

- Output Range: 0 to  $-127$  DBM
- Output Accuracy:  $\pm 2$  db
- Output Impedance: 50 ohms nominal

### RF Pulse Characteristics:

- a. Rise Time: Better than 0.1 microsecond as measured between 10 and 90% of maximum amplitude of the initial rise.
- b. Decay Time: Less than 0.1 microsecond as measured between 10 and 90% of maximum amplitude of the final decay.
- c. Overshoot: Less than 10% of maximum amplitude of the initial rise.

### Internal Pulse Modulation:

- No. of Channels: 1 to 5 independently on or off
- Repetition Rate: 40 to 4000 cps.
- Pulse Width: 0.2 to 2.0 microseconds
- Pulse Delay: 0 to 30 microseconds
- Accuracy of Pulse Setting: 0.1 microsecond
- Minimum Pulse Separation: 0.3 microsecond
- Initial Channel Delay: 2 microseconds from sync. pulse
- Internal Square Wave: 40-4000 pps (separate output)

### Pulse Time Modulation:

- Frequency: 40-400 cps any or all channels
- Required Ext. Mod.: 1 volt rms min.
- Maximum deviation:  $\pm 0.5$  microsecond

Power Input (built-in power supply) 105/125 v. 60 cps 1200 watts.

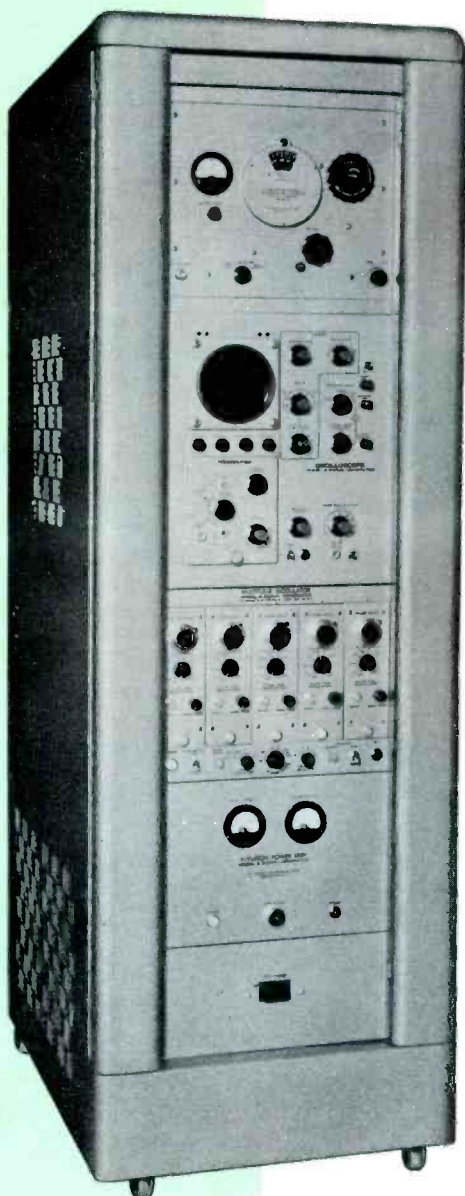

## FOUR INTERCHANGEABLE MICROWAVE OSCILLATOR UNITS

— all stored in the instrument... each with UNI-DIAL control... precision power monitor circuit to maintain 1 mw power output reference level... keying circuit to assure rapid rise time of modulated r-f output... non-contacting chokes.

## PRECISION OSCILLOSCOPE WITH BUILT-IN WIDE BAND RF DETECTOR

for viewing the modulation envelope and accurately calibrating the r-f pulse width, delay, and group repetition rate. Equipped with built-in calibration markers.

## FIVE INDEPENDENTLY ADJUSTABLE PULSE CHANNELS

— each channel features variable pulse width and delay; has provisions for external pulse-time modulation. Repetition rate for each group of pulses can be varied.

## SELF-CONTAINED POWER SUPPLIES

— Model B operates directly from an AC line through an internal voltage regulator. The coded multipulse generator is equipped with an electronically regulated low voltage DC supply. Klystron power unit adjusts to proper voltage automatically for each interchangeable tuning unit.

Model B

Contact your Polarad representative or write to the factory for detailed information.

**POLARAD ELECTRONICS CORPORATION**

43-20 34th Street, Long Island City 1, New York



REPRESENTATIVES: Abington, Albany, Atlanta, Baltimore, Boeing Field, Chicago, Cleveland, Dayton, Denver, Detroit, Englewood, Fort Worth, Kansas City, Los Angeles, Portland, Rochester, St. Louis, Stamford, Sunnyvale, Syracuse, Washington, D. C., Westbury, Westwood, Wichita, Winston-Salem, Canada: Arnprior, Ontario. Resident Representatives in Principal Foreign Cities.

# ENGINEERING REPORT

*A Case History of Environmental Control*

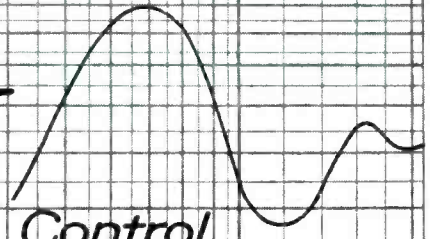

## PROBLEM

**VIBRATION • SHOCK  
AND COOLING**

**POWER TUBE FAILURE** during environmental testing of the Servo-Amplifier in the flight stabilization system of Chance Vought's F8U-1 Crusader.

## SOLUTION

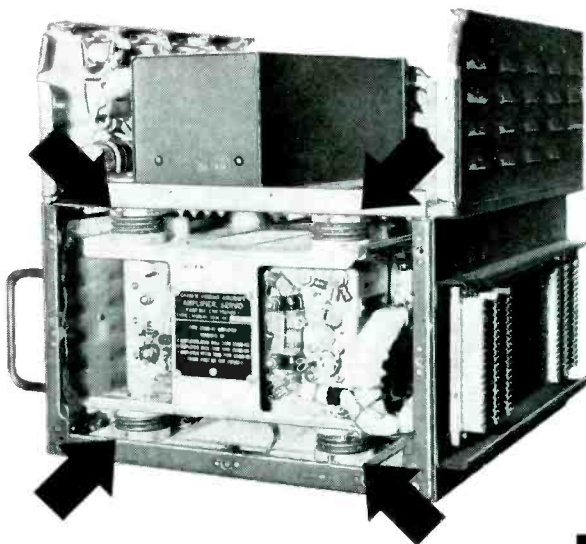

### ENGINEERED MOUNTING SYSTEM:

Robinson Model 1514 all-metal light-weight mounting system to protect entire Servo-Amplifier assembly. Highly damped Met-L-Flex resilient elements are incorporated in an opposed cushioning design. Resulting center-of-gravity suspension system assures all attitude protection for power tube and other electronic components.

*The Servo-Amplifier assembly was isolated with no increase in over-all equipment dimensions.*

### SPECIAL FEATURE:

Range of environmental protection is extended by screened cooling apertures designed as part of the combined chassis and mounting.

### PERFORMANCE:

Natural frequency of the mounting system is between 15-21 c.p.s. After 15 G drop tests on all six sides, there was no loss of isolation efficiency which remained as high as 90% at 55 c.p.s. with .060 inches excursion.

### RESULT:

1. Increased operational reliability of Chance Vought's supersonic Crusader.
2. Another contribution to the weapons system reliability program pioneered by Chance Vought Aircraft, Inc. in cooperation with Robinson engineers.

ROBINSON CONTROL IS RELIABILITY CONTROL

# ROBINSON

AVIATION, INC.

Teterboro, New Jersey

West Coast Engineering Office, Santa Monica, California

# FREQUENCY STANDARDS

## PRECISION FORK UNIT TYPE 50



\*3 1/8" high  
400 - 1000 cy.

*Size 1" dia. x 3 3/4" H.\* Wght., 4 oz.*  
Frequencies: 240 to 1000 cycles  
Accuracies:—  
Type 50 ( $\pm 0.02\%$  at  $-65^{\circ}$  to  $85^{\circ}\text{C}$ )  
Type R50 ( $\pm 0.002\%$  at  $15^{\circ}$  to  $35^{\circ}\text{C}$ )  
Double triode and 5 pigtail parts required  
Input, Tube heater voltage and B voltage  
Output, approx. 5V into 200,000 ohms

## FREQUENCY STANDARD TYPE 50L



*Size 3 3/4" x 4 1/2" x 5 1/2" High  
Weight, 2 lbs.*  
Frequencies: 50, 60, 75 or 100 cycles  
Accuracies:—  
Type 50L ( $\pm 0.02\%$  at  $-65^{\circ}$  to  $85^{\circ}\text{C}$ )  
Type R50L ( $\pm 0.002\%$  at  $15^{\circ}$  to  $35^{\circ}\text{C}$ )  
Output, 3V into 200,000 ohms  
Input, 150 to 300V, B (6V at .6 amps.)

## PRECISION FORK UNIT TYPE 2003



\*3 1/2" high  
400 to 500 cy.  
optional

*Size 1 1/2" dia. x 4 1/2" H.\* Wght. 8 oz.*  
Frequencies: 200 to 4000 cycles  
Accuracies:—  
Type 2003 ( $\pm 0.02\%$  at  $-65^{\circ}$  to  $85^{\circ}\text{C}$ )  
Type R2003 ( $\pm 0.002\%$  at  $15^{\circ}$  to  $35^{\circ}\text{C}$ )  
Type W2003 ( $\pm 0.005\%$  at  $-65^{\circ}$  to  $85^{\circ}\text{C}$ )  
Double triode and 5 pigtail parts required  
Input and output same as Type 50, above

## FREQUENCY STANDARD TYPE 2005

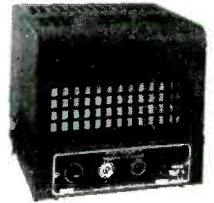

*Size, 8" x 8" x 7 1/4" High  
Weight, 14 lbs.*  
Frequencies: 50 to 400 cycles  
(Specify)  
Accuracy:  $\pm 0.001\%$  from  $20^{\circ}$  to  $30^{\circ}\text{C}$   
Output, 10 Watts at 115 Volts  
Input, 115V. (50 to 400 cycles)

## FREQUENCY STANDARD TYPE 2007T TRANSISTORIZED



\*3 1/2" in 2007S, 400 to 800 cycles.

*Size 1 1/2" dia. x 4 1/2" H.\* Wght. 7 ozs.*  
Frequencies: 240 to 1000 cycles  
Accuracies:—Same as 2003, above  
Type 2007S—Silicon type  
Input, 28V.  
Output, Multitap, 75 to 100,000 ohms

## FREQUENCY STANDARD TYPE 2121A



*Size  
8 3/4" x 19" panel  
Weight, 25 lbs.*  
Output: 115V  
60 cycles, 10 Watt  
Accuracy:  
 $\pm 0.001\%$  from  $20^{\circ}$  to  $30^{\circ}\text{C}$   
Input, 115V (50 to 400 cycles)

## FREQUENCY STANDARD TYPE 2001-2

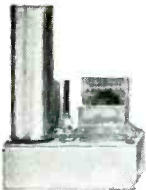

*Size 3 3/4" x 4 1/2" x 6" H., Wght. 26 oz.*  
Frequencies: 200 to 3000 cycles  
Accuracy:  $\pm 0.001\%$  at  $20^{\circ}$  to  $30^{\circ}\text{C}$   
Output: 5V. at 250,000 ohms  
Input: Heater voltage, 6.3 - 12 - 28  
B voltage, 100 to 300 V., at 5 to 10 ma.

## FREQUENCY STANDARD TYPE 2111C

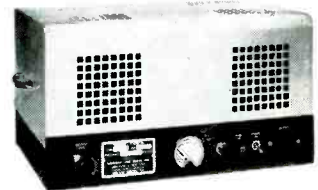

*Size, with cover  
10" x 17" x 9" H.  
Panel model  
10" x 19" x 8 3/4" H.  
Weight, 25 lbs.*  
Frequencies: 50 to 1000 cycles  
Accuracy: ( $\pm 0.002\%$  at  $15^{\circ}$  to  $35^{\circ}\text{C}$ )  
Output: 115V, 75W. Input: 115V, 50 to 75 cycles.

## ACCESSORY UNITS for TYPE 2001-2



L—For low frequencies  
multi-vibrator type, 40-200 cy.  
D—For low frequencies  
counter type, 40-200 cy.  
H—For high freqs, up to 20 KC.  
M—Power Amplifier, 2W output.  
P—Power supply.

*This organization makes frequency standards  
within a range of 30 to 30,000 cycles. They are  
used extensively by aviation, industry, govern-  
ment departments, armed forces—where maxi-  
mum accuracy and durability are required.*

WHEN REQUESTING INFORMATION  
PLEASE SPECIFY TYPE NUMBER

# American Time Products, Inc.

580 FIFTH AVENUE, NEW YORK 36, N. Y.

# PYLE *star-line* CONNECTORS

Assure long-lasting protection of vital connections under a wide range of extreme environmental conditions

Currently establishing itself as a performance leader in the missile systems field, Pyle-Star-Line connectors offer engineers an entirely new line of electrical connectors for universal military and industrial use.

With characteristics of construction and performance never before combined in compact, rugged, lightweight standardized connectors, they exceed NEC requirements and classes A, B, C and E of military specifications MIL C-5015C.

## FEATURES

**Tough, lightweight shell:** Strength comparable to mild steel, yet weighs only 1/3 as much.

**Anodic coating:** Gives shell toughness of case-hardened steel. Takes up to 1800 volts to penetrate coating.

**"Sandwich" insulation:** Silicone laminate floats between two rigid discs. Silicone disc absorbs shock, lets contacts align themselves freely; rigid discs impart just the right amount of restraint. Gives all advantages of both flexible and rigid mountings.

**Chamber sealing:** Silicone insulation disc positively and completely prevents water, gas, moisture or dust from passing into shell.

**Wide range of pin and socket configurations:** Configurations from 2 to 100 poles available. Within each form size all inserts are interchangeable and reversible.

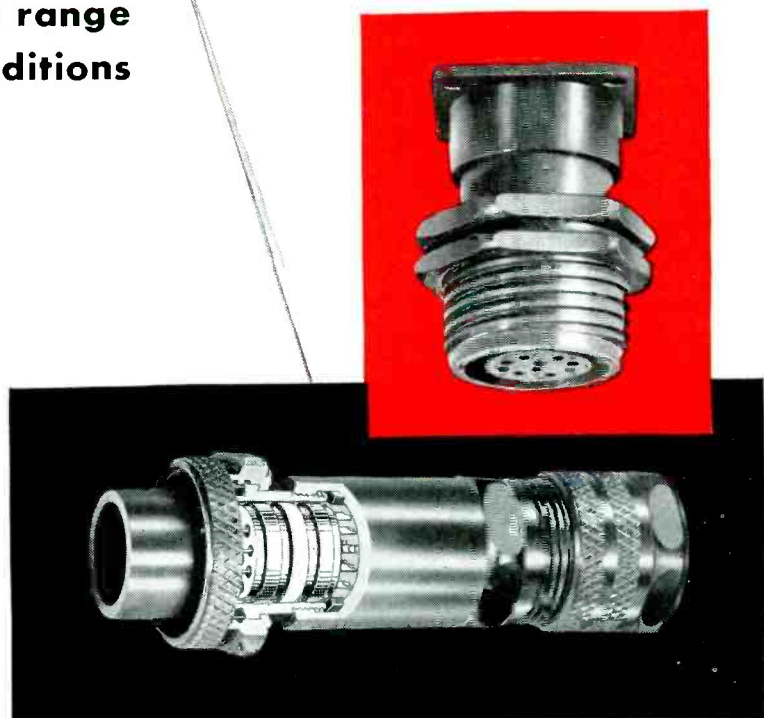

Environmental Limits of Pyle-Star-Line connectors	
Temperature	-80 F. to 225 F.
Pressure	300 PSI External, 200 PSI Internal
Chemical Resistance	Most acids, most alkalis, oil
Corrosion Resistance	Salt Spray: 300 days without failure
Dust Resistance	Exceed requirements of MIL C-5015C
Shock Resistance	50G Minimum
Vibration	Exceed 20G to Method II of Mil C-5015C
Humidity & Moisture Resistance	Exceed Class E. Spec. of Mil C-5015C
Air Leakage	Meet Class E Spec. of Mil C-5015C

Write today for complete specifications.

**the PYLE-NATIONAL company**



Where Quality is Traditional

1330 North Kostner Avenue, Chicago 51, Illinois

District Offices and Representatives in Principal Cities of the United States  
**CONDUIT FITTINGS • CIRCUIT CONTROLS • LIGHTING EQUIPMENT**



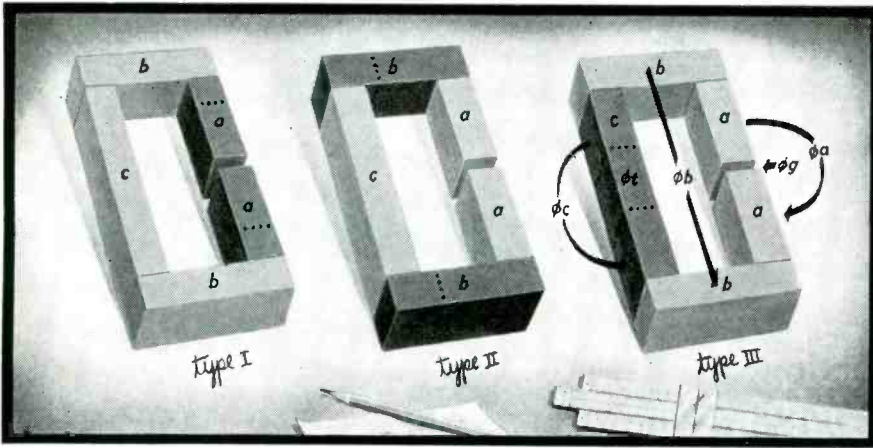

## How You Can Save Time Estimating Leakage Factors for Magnetic Circuits

Computing even approximate values for leakage flux in magnetic circuits is a time consuming job. The research department of Indiana Steel recently undertook a series of studies, supported by the U.S. Air Force, to simplify these computations. Dr. R. K. Tenzer reported the results of this work, which reduce the time in computing leakage flux up to 90% by diminishing the number of mathematical operations necessary.

The investigations were done on circuits with permanent magnets; the results were also found applicable to unsaturated electromagnetic circuits when the coil-covered parts were treated as permanent magnet parts.

After checking values obtained by this method with actual measured values for many Type I, II, and III magnetic circuits, deviations were found to be less than  $\pm 10\%$ .

### Leakage Flux, Leakage Factor

Because of magnetic leakage, only a part of the total flux through the neutral zone of the permanent magnet is found in the air gap. The difference between these two values is known as leakage flux. Mathematically this is:

$$\phi_L = \phi_t - \phi_o \quad (1)$$

In practical design, leakage is best considered as a factor stated thus:

$$\sigma = \frac{\phi_t}{\phi_o} = 1 + \frac{\phi_L}{\phi_o} \quad (2)$$

For simplification, the flux can be assumed to follow three basic, probable paths:  $\phi_a$  between parts *a*,  $\phi_b$  between parts *b*, and  $\phi_c$  along part *c*. The equation above then becomes:

$$\sigma = 1 + \frac{\phi_a + \phi_b + \phi_c}{\phi_o} \quad (3)$$

With  $\phi = mmf \times P$ , this formula can be written:

$$\sigma = 1 + \frac{1}{P_o} \left( \frac{mmf_a P_a}{mmf_o} + \frac{mmf_b P_b}{mmf_o} + \frac{mmf_c P_c}{mmf_o} \right) \quad (4)$$

Letting the *mmf* ratios be denoted by *K*,

$$\sigma = 1 + \frac{1}{P_o} \left( K_a P_a + K_b P_b + K_c P_c \right) \quad (5)$$

This becomes the basic equation for numerical calculations of leakage factors after introducing simple expressions for leakage permeances and *mmf* ratios.

### Simplified Leakage Permeances

The following formulas have been found satisfactory for leakage permeances between soft steel parts:

$$P_a = 1.7 \times U_a \times \frac{a}{a + L_o} \quad \text{where } U \text{ is cross-section perimeter;} \quad (6)$$

$$P_b = 1.4 \times b \times \sqrt{\frac{U_b}{c} + .25} \quad (7)$$

where  $U_b/c$  is greater than .25 and less than 4. The total length of part *b* is used.

Since permanent magnets have a neutral zone which does not contribute to leakage, the value of 2/3 of the magnet's total length is used when computing leakage permeances—this is the effective length  $a'$  and  $b'$  to compute  $P'$ ; thus the two equations above become:

$$P'_a = 1.7 U_a \frac{.67a}{.67a + L_o} \quad (6a)$$

and

$$P'_b = 1.4 \times .67b \sqrt{\frac{U_b}{c} + .25} = .67 P_b \quad (7a)$$

When part *c* consists of a permanent magnet (Type III) its permeance can be calculated as:

$$P_c = .5 U_c \quad (8)$$

The permeance of the air gap itself is

$$P_o = A_o / L_o \quad (9)$$

### Simplified MMF Ratios

Simplifying the *mmf* ratios is done by neglecting the reluctance in soft steel parts; so

$$mmf_a = mmf_b = mmf_o \text{ or } K_a = K_b = 1 \text{ (} mmf_c = 0 \text{ so } K_c = 0 \text{).} \quad (10)$$

Since the *mmf* along permanent magnet parts is not constant, integral values ( $\overline{mmf}$ ) are used. Experiments showed that 2/3 of the  $mmf_o$  was the effective *mmf* for leakage flux between permanent magnet parts; thus

$$\overline{mmf}_a = \overline{mmf}_b = \overline{mmf}_c = 2/3 mmf_o \text{ or } K_a = K_b = K_c = 2/3. \quad (11)$$

### Basic Formulas

By inserting the permeances for soft steel into equation (5), the general formula becomes:

$$\sigma = 1 + \frac{L_o}{A_o} \left( K_a \times 1.7 U_a \frac{a}{a + L_o} + K_b \times 1.4 b \sqrt{\frac{U_b}{c} + .25} + K_c \times .5 U_c \right) \quad (12)$$

This formula contains only constants and dimensions; and by the two following rules this can be modified into the three basic equations for the Type I, Type II, and Type III circuits.

Rules: (1) For leakage flux paths between soft steel parts, use total lengths and constant *K* of 1. (2) For leakage flux paths between permanent magnet parts, use 2/3 of lengths and *K* of .67.

The following provide the leakage factors for the three types of circuits:

Type I:

$$\sigma = 1 + \frac{L_o}{A_o} \times .67 \times 1.7 U_a \frac{.67a}{.67a + L_o}$$

Type II:

$$\sigma = 1 + \frac{L_o}{A_o} \left( 1.7 U_a \frac{a}{a + L_o} + .67 \times .67 \times 1.4 b \sqrt{\frac{U_b}{c} + .25} \right)$$

Type III:

$$\sigma = 1 + \frac{L_o}{A_o} \left( 1.7 U_a \frac{a}{a + L_o} + 1.4 b \sqrt{\frac{U_b}{c} + .25} + .67 \times .5 U_c \right)$$

For variations on these basic formulas, write today for the April-June issue of *Applied Magnetism* which also shows examples of the formulas in use.

### NEW DESIGN MANUAL READY

Write today for your copy of the newest edition of the Indiana Permanent Magnet Design Manual No.6. Write to Dept. A-12.



**THE INDIANA STEEL PRODUCTS COMPANY**  
VALPARAISO, INDIANA

**THE WORLD'S LARGEST MANUFACTURER OF PERMANENT MAGNETS**

**INDIANA PERMANENT MAGNETS**

In Canada . . . The Indiana Steel Products Company of Canada Limited, Kitchener, Ontario

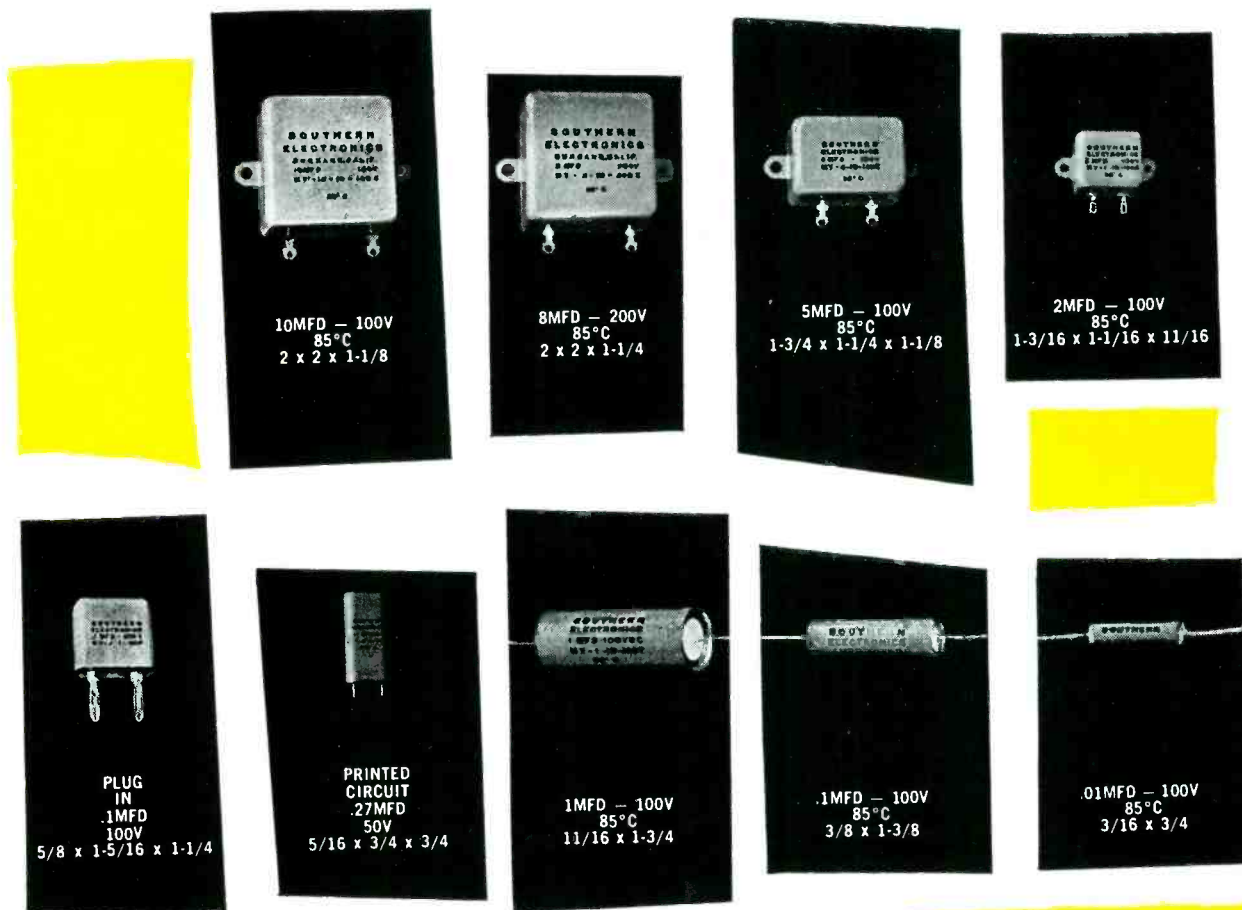

*At last!*  
**Mycon Plastic**  
**Capacitors**  
*up to 150° C!*

- *Reliability proved*
- *Rated for infinite long life*
- *Insulation resistance  $1 \times 10^{11}$  OHMS*

Wire, write or phone for complete catalog today!

**SOUTHERN ELECTRONICS**  
*Corporation*

150 West Cypress Avenue, Burbank, California  
 NEW DISTRICT OFFICE: 1186 Broadway, New York City Phone OR 9-2770  
 PIONEERS IN CUSTOM CAPACITOR ENGINEERING

Derated at 125°C as follows:

- 100 volts — 50%
- 200 volts — 50%
- 300 volts — 33½%
- 400 volts — 33½%
- 500 volts — 20%
- 600 volts — 16%

Tested and proved! Only Southern Electronics Corporation has developed a test procedure which insures built-in reliability! For your most exacting requirements—be sure—always specify S.E.C.

**SUPER MYCON CAPACITORS**  
 Tolerance to 1%—lowest temperature coefficient. Superior insulation resistance at high ambient temp. Good stability compatible with material.



# THE HEART

## of this Differential Voltmeter

### is an Airpax. Chopper

A chopper amplifier extends the range of this null-reading VTVM down to  $0 \pm 0.01$  DC volt. An Airpax Type 175 chopper modulates the input signal at 60 CPS so that it can readily be amplified and then the chopper synchronously rectifies the signal and returns it to the DC portion of the meter.

Here is another example of how a reliable chopper helps provide the stability essential to modern electronic equipment. This particular instrument is one of the precision laboratory meters developed by John Fluke Manufacturing Co., Seattle, Washington.

Type 175 chopper is one of the Airpax family of miniature choppers. For full details just write to

#### CHARACTERISTICS OF TYPE 175 CHOPPER

##### Drive

Frequency - - - - -  $60 \pm 3$  CPS  
Voltage - - - - -  $6.3 \pm 0.6$  RMS volts

##### Contacts

Dwell Time -  $167 \pm 10$  electrical deg.  
Balance - - - within 15 electrical deg.  
Phase angle -  $20 \pm 5$  electrical deg.  
Voltage - - - - - up to 100 DC volts  
Current - - - - - up to 2 MA  
Noise - - - - - 50 microvolts average  
Life - - - - - 2,000 hours

Hermetically sealed for trouble-free operation in any atmosphere, humidity, or altitude.



DESIGNERS

ENGINEERS

MIDDLE RIVER • BALTIMORE 20, MD.



# Custom Wire & Cable Specs Got You At Sea ?



## PHALO Will Know The Way Home!

It gets pretty rough at sea sometimes — especially when they're screaming for "that certain wire or cable". So how do you get home with the right answer? Well, if you're a thinking man (and we're sure you are), you think of PHALO . . . the custom wire and cable house who have helped more people in your position than almost any firm in the country.

Set the compass for home, engineer, call for PHALO and ease the tension!

*Here's one way to keep out of trouble — Get This Catalog!*



**PHALO**

**PLASTICS CORPORATION**

Corner of Commercial Street

WORCESTER, MASSACHUSETTS

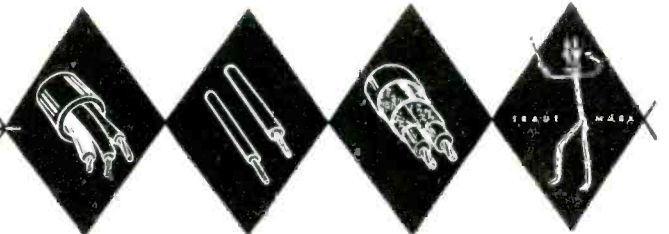

# WESTINGHOUSE MAGAMP

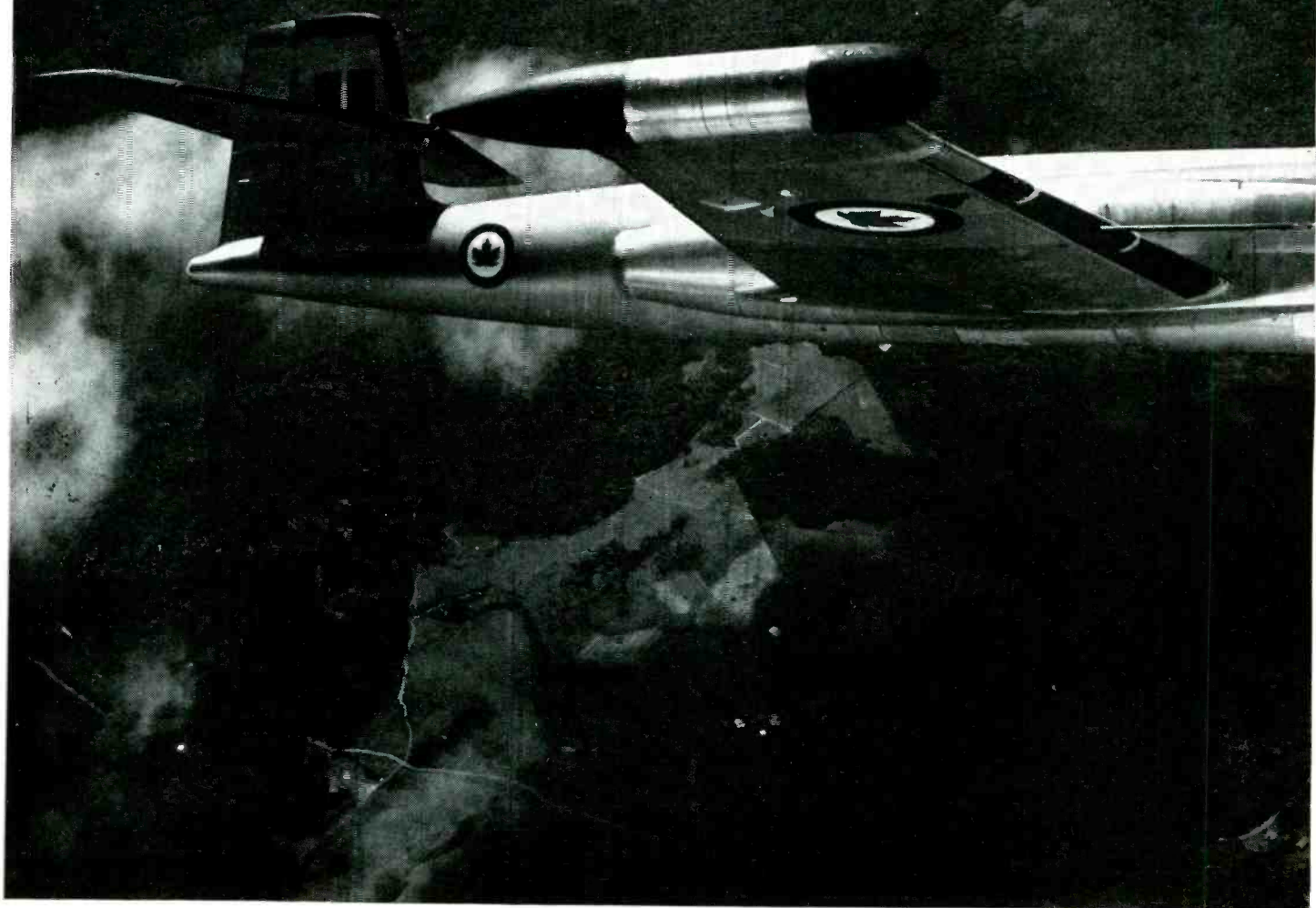

Another Example of CREATIVE MAGAMP ENGINEERING By Westinghouse

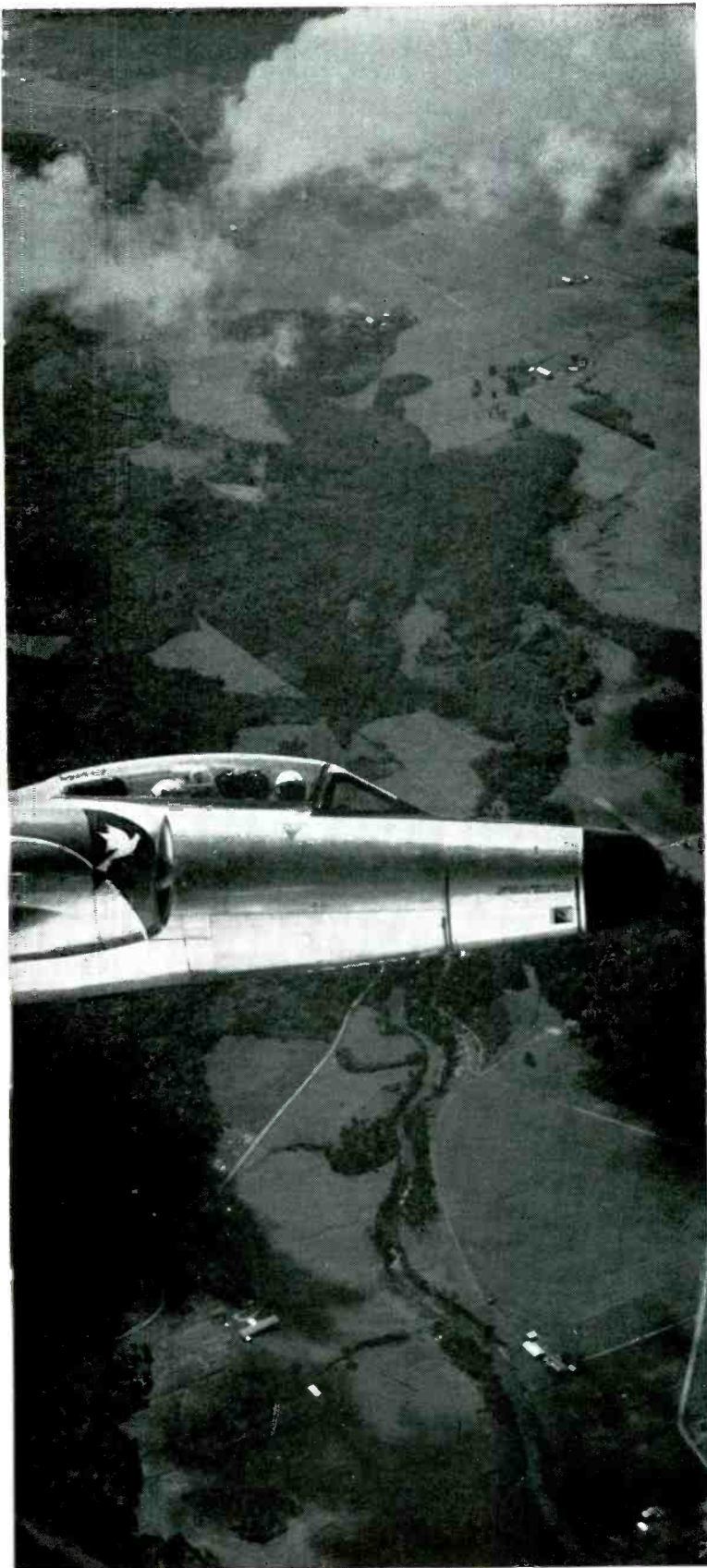

## World's Lightest Magnetic Amplifier Regulator Unit . . . Capable of Voltage Regulation Plus or Minus 1 Volt up to 120° C.

The high altitude missile-carrying CF-100 Mark VI, designed and developed by Avro Aircraft Ltd., of Canada, is undergoing advanced flight testing. Complete dependability and fast response are critical in control and power supply components for these all-weather aircraft. That's why Westinghouse transformer-rectifier unit with MAGAMP\* static control was specified — it assures electrical system reliability over a wide range of temperatures and altitudes on aircraft and guided missiles.

Using a 12-phase amplifier and silicon rectifiers, Westinghouse can obtain an output of 5.6 kw . . . yet the unit occupies less than one cubic foot and weighs only 62 pounds. By designing reactors that will operate at 200°C internal temperatures, Westinghouse engineers are able to provide the only magnetic amplifier voltage regulator on the market that will operate at a sea-level temperature of -55°C to +120°C.

This is an example of Westinghouse creative MAGAMP engineering to solve today's problems and tomorrow's applications. For information or engineering assistance on your specific control problems, call your Westinghouse sales engineer, or write Westinghouse Electric Corporation, P.O. Box 868, 3 Gateway Center, Pittsburgh 30, Pennsylvania.

\*TRADE-MARK

J-22030

### MAGAMP STATIC REGULATOR CHARACTERISTICS

**INPUT**  
190 to 210 volts rm-3 phase

**OUTPUT**  
28 volts at 200 amperes

**FREQUENCY RANGE**  
380 to 420 cps

**RIPPLE**  
1.5-volt peak ripple

**TRANSIENT RESPONSE**  
0.2-second maximum

**EFFICIENCY**  
Minimum of 80% at full load

**PERFORMANCE**  
As specified in MIL-E 5272 A

**LIFE**  
1,000 hours minimum with no  
maintenance or adjustments.

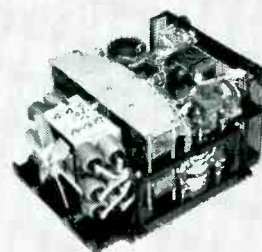

YOU CAN BE SURE...IF IT'S **Westinghouse**



# Foremost in the application of Electronics

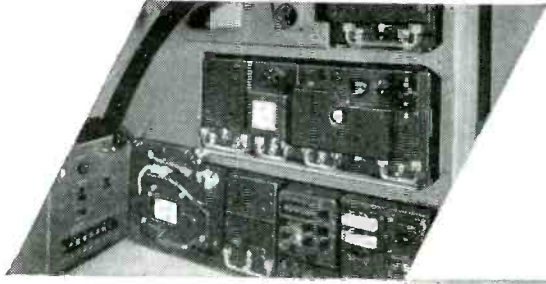

**IN AVIATION** Over 30 Air Forces rely on Marconi radio, radar or navigational aids. For over three years Marconi's have been in quantity production with Doppler navigators for British and Commonwealth Governments.

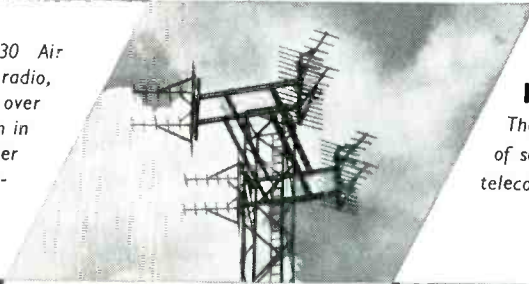

**IN TELECOMMUNICATIONS** The Post and Telegraph Authorities of some 80 countries use Marconi telecommunications equipment.

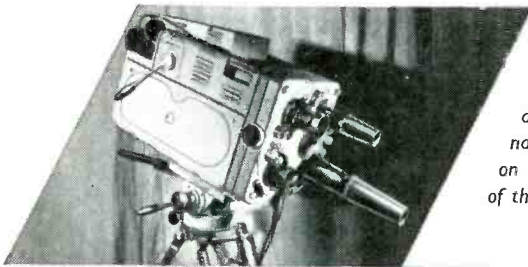

**AT SEA** Marine communication and radar equipment for navies and merchant fleets. Marconi navigation beacons are to be found on all the main shipping routes of the world.



**IN BROADCASTING AND TELEVISION** The Broadcasting Authorities of 75% of the countries of the world are using Marconi sound broadcasting or television equipment.



**IN VALVES AND CRYSTALS** Valves of all powers and types, magnetrons, klystrons, stabilovolts, travelling wave tubes and television camera tubes. Crystals for all requirements up to the highest grade unit employed in frequency measuring.

**IN RADAR** The armed Services of Great Britain and many other countries rely on Marconi's radar for defence, surveillance, navigation and airport control.

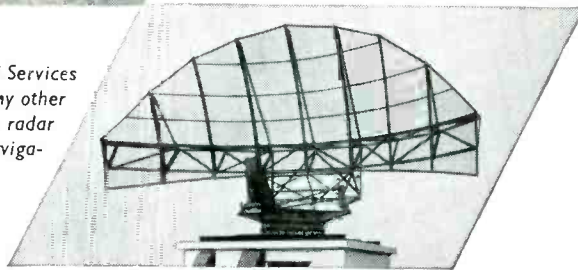

# MARCONI

*on land, at sea and in the air*

The inquiries of radio and electronic engineers who wish to keep themselves posted about the latest Marconi equipment and activities are most welcome. Write to:

J. S. V. WALTON, MARCONI'S WIRELESS TELEGRAPH COMPANY LIMITED, 23-25 Beaver Street, New York City 4

MARCONI'S WIRELESS TELEGRAPH COMPANY, LIMITED, CHELMSFORD, ESSEX, ENGLAND

LG 24

# OHMITE®

offers the  
complete line of  
**RESISTORS**  
to meet MIL-R-26C  
characteristics

**Y** HIGH TEMPERATURE  
350C CHARACTERISTIC  
HIGH INSULATION RESISTANCE

**V** HIGH TEMPERATURE  
350C CHARACTERISTIC

AND **G**

### TAB- TERMINAL TYPE

Characteristics  
V and G

Style	Over-all		*Watts	††Watts
	Length	Diameter		
RW-29	1 3/4"	1/2"	8	11
RW-30	1"	19/32"	8	11
RW-31	1 1/2"	19/32"	10	14
RW-32	2"	19/32"	12	17
RW-33	3"	19/32"	18	26
RW-35	4"	29/32"	38	55
RW-36	4"	1-5/16"	54	78
RW-37	6"	1-5/16"	78	113
RW-38	8"	1-5/16"	110	159
RW-47	10 1/2"	1-5/16"	145	210

### TAB- TERMINAL TYPE

Characteristic  
Y

Style	Over-all		*Watts	††Watts
	Length	Diameter		
RW-30	1"	19/32"	8	11
RW-33	3"	19/32"	18	26
RW-37	6"	1-5/16"	78	113
RW-47	10 1/2"	1-5/16"	145	210

### FLAT TAB- TERMINAL TYPE

(Stack Mounting)  
Characteristics  
V and G

Style	Over-all Length	Width and Thickness of Core	*Watts	††Watts
RW-21	3 1/4"	1-3/16"	22	31
RW-22	4 3/4"	x	37	53
RW-23	6"	1/4"	47	68
RW-24	7 1/4"		63	91

### AXIAL- TERMINAL TYPE

Characteristics  
V and G

Style	Length of Core**		*Watts	††Watts
	Core**	Diameter		
RW-55	1 3/4"	15/32"	5	7
RW-56	2"	15/32"	10	14
RW-57	1"	5/16"	5	6.5
RW-58	1 7/8"	11/32"	8	11
RW-59	1/2"	3/16"	2.5	3

\*Watts free air MIL Characteristic "G."  
†Watts free air MIL Characteristic "Y."  
††Watts free air MIL Characteristic "V."

\*\*1-1/2" wire leads.

Even including resistors  
wound with the finest  
wire size (.00175)

The Ohmite resistor types shown in the table above can withstand a continuous operating temperature of 350C—the high temperature requirement of MIL-R-26C, Char. "V." These resistors also meet Characteristic "G." The new Char. "Y" combines all requirements of Char. "V" and "G" plus extremely high insulation resistance at the end of the moisture-resistance test. Under all three Char., "V," "Y," and "G," Ohmite resistors have to satisfy severe moisture-resistance tests, thermal shock tests, vibration tests, and many others. The Ohmite line of wire-wound resistors is the most extensive available in the industry.

ALL  
CHARACTERISTICS  
\*  
ALL SIZES  
\*  
ALL RESISTANCE  
VALUES



PATENTED, ALL-WELDED  
CONSTRUCTION

WRITE FOR BULLETIN 139

Be Right with

# OHMITE®

RHEOSTATS  
RESISTORS  
RELAYS  
TAP SWITCHES  
TANTALUM CAPACITORS  
VARIABLE RESISTORS

OHMITE MANUFACTURING COMPANY, 3610 Howard Street, Skokie, Illinois

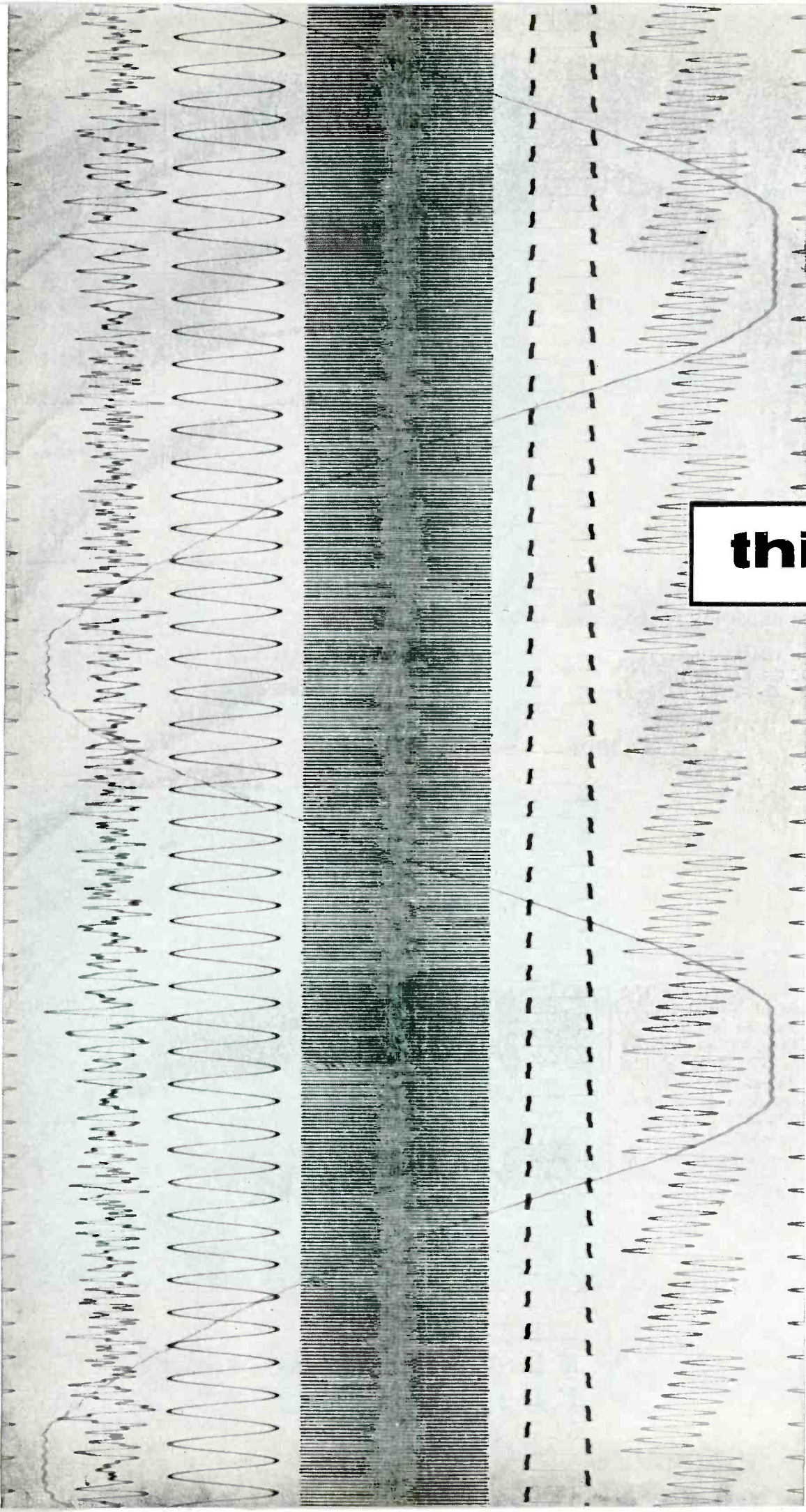

**this is**



This Visicorder Oscillograph record\* is a symbol of the leadership that is typical of Honeywell engineering. In laboratories all over the world the Visicorder's instantly-readable direct records are showing the way to new advances in rocketry, control, computing, product design and component test and in nuclear research.

\*reproduced actual size, unretouched

The Model 906 Visicorder is years ahead of the trend. It is the first oscillograph that combines the convenience of direct recording with the high frequencies and sensitivities of photographic-type instruments. The Visicorder alone among oscillographs lets you monitor high-speed variables as they go on the record.

## a record of leadership

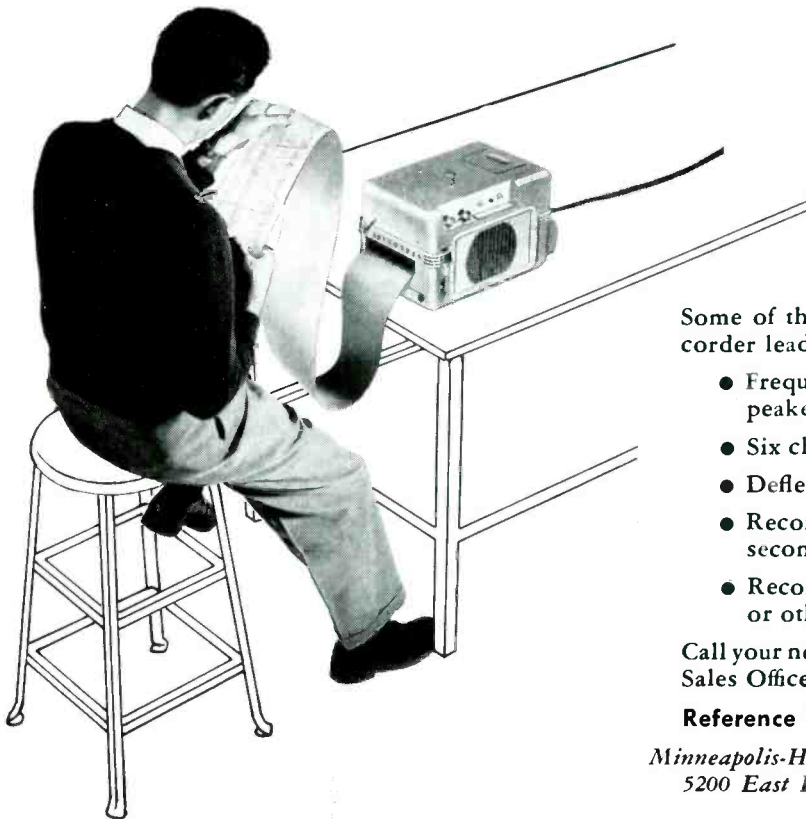

Some of the general features which give the Visicorder leadership in the direct-recording field are:

- Frequencies from DC to 2000 cps without peaked amplifiers or other compensation
- Six channels plus 2 timing traces on 6" paper
- Deflection 6" peak to peak; traces may overlap
- Record speeds 0.2, 1, 5, and 25 inches per second, minute, or hour
- Records require no liquids, powders, vapors, or other processing

Call your nearest Minneapolis-Honeywell Industrial Sales Office for a demonstration.

**Reference Data: Write for Visicorder Bulletin**

*Minneapolis-Honeywell Regulator Co., Heiland Division,  
5200 East Evans Avenue, Denver 22, Colorado.*

MINNEAPOLIS  
**Honeywell**



*Heiland Division*

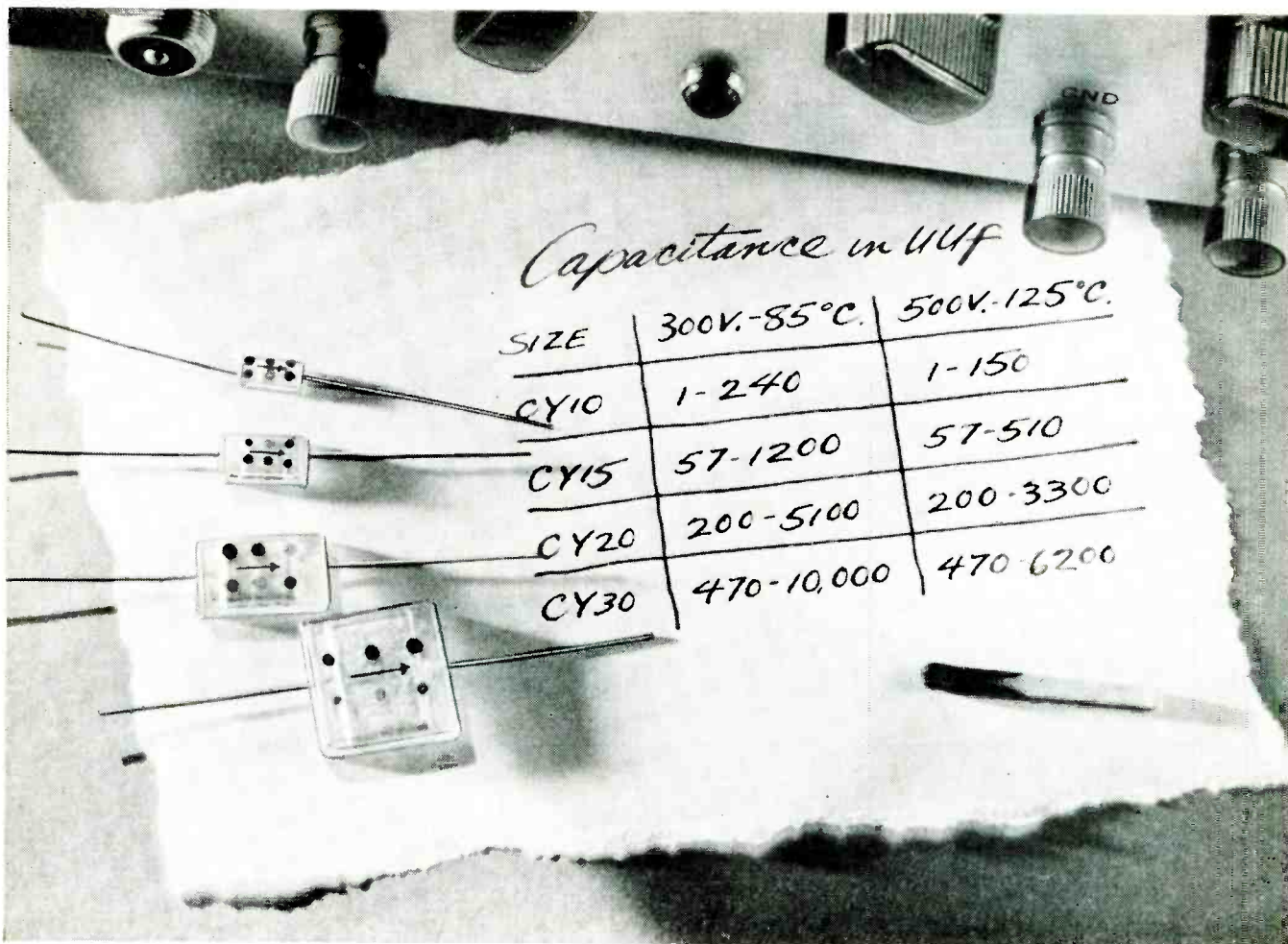

## *uuf* for *uuf*, the smallest, most stable, fixed capacitors you can buy—Here's why...

These are *glass* capacitors—probably as much as one-third smaller than those you're used to; certainly much lighter.

Though made with glass, they are *not* fragile. In fact, the layers of glass dielectric, the metal foil plates and the leads are fused into a surprisingly rugged, inseparable unit.

This unusual construction, developed at Corning offers you these advantages:

**Small size, light weight.** If you're at work on guided missiles, fire controls, computers, and similar devices, you can cut valuable ounces and inches from your assemblies with these capacitors. See table above for some indications.

**Exceptional stability.** After a load life test at 50% more than rated voltage at

### Capacitance in uuf

Size	300 V. —85° C.	500 V. —125° C.
CY10	1-240	1-150
CY15	57-1200	57-510
CY20	200-5100	200-3300
CY30	470-10,000	470-6200

85° C., the average change in capacitance of these units is less than 0.4% after 1,000 hours, less than 0.6% after 10,000 hours.

**Very low drift.** This drift is so slight that it's generally within the normal error of measurement. Taking MIL-C-11272A as a standard, capacitance drift is less than 0.1% or 0.1 *uuf* (whichever is greater).

**Predictable, retraceable TC.** The difference in TC between any units at any given temperature is less than 15 ppm/° C. It is well within the limits of  $140 \pm 25$  ppm/° C. from -55° C. to +85° C. and referred to 25° C.

**Low loss.** Even at elevated temperatures, the dielectric loss is relatively low. Dissipation factor at 1 kc. and 25° C. is about 0.055% and independent of capacitance.

**Other electronic products by Corning Components Department:** Glass Film Type Resistors\*, LP, LPI, H, R, N, S, HP and Water Cooled Styles. Direct Traverse and Midget Rotary Trimmer Capacitors\*. Metallized Glass Inductances, Delayline Coil Forms, Bushings, Enclosure Tubes, Rectifier Tubes and Attenuator Plates.

**Bulletin shows performance charts.** Bulletin CD-1.00 contains charts and other data on these capacitors. Circle this magazine's service card for a copy or write us direct at Corning.

### Ask for information on these other Corning Capacitors:

**Medium Power Transmitting**—CY60 and CY70. Ideal for mobile RF transmitters.

**Canned High Capacitance**—Provide the advantages of rugged glass design to your specifications.

**Subminiature Tab-Lead**—Up to 90% less volume compared to pigtail types. To your specifications.

**Special Combinations**—The performance and benefits of glass in infinite shapes, sizes and leads. To custom order.

\*Distributed by Erie Resistor Corporation

Corning means research in Glass



**CORNING GLASS WORKS, 94-12 Crystal Street, Corning, N. Y.**

Electronic Components Department



**ACCURATE  
INDICATION  
OF 0.0002%  
OXYGEN,  
0.0004%  
HYDROGEN**



The detection and indication of the faintest traces of oxygen or hydrogen in gases like Nitrogen, Carbon Dioxide, Argon, Helium, Neon or saturated hydrocarbons is now possible with the Super-Sensitive Deoxo Indicator. The measurement range of this super-sensitive equipment is from 0.0002% to 0.0200% (2 to 200 parts per million) oxygen and from 0.0004% to 0.0400% hydrogen. A dual range allows measurement of up to 0.25% oxygen and 0.5% hydrogen, should the amount present be in excess of the super-sensitive range.

Baker's Super-Sensitive Deoxo Indicator offers many outstanding features aside from the great sensitivity. A self-contained calibrating unit and a recorder for a continuous, permanent record are included as integral parts of the unit. A recorder-controller can be supplied in place of the recorder, if desired.

The Super-Sensitive Deoxo Indicator operates by measurement of the temperature increase of the gas sample. This increase results from catalytic combination of the oxygen impurity with hydrogen, or the hydrogen impurity with oxygen, depending upon which gas is to be indicated. The reacting gas, either hydrogen or oxygen, is generated in a self-contained electrolytic cell.

Ideal for analysis of gases used in sintering, annealing (stainless and alloy steels), filling of vacuum tubes and lamps, and liquification of gas, the Super-Sensitive Deoxo Indicator is of particular value in all processes that require oxygen-free atmosphere.

Write for complete catalog material and details.

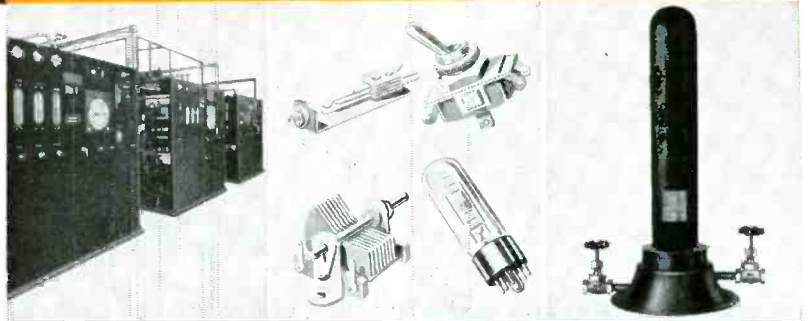

**NITRONEAL® GAS GENERATOR** economically and safely provides forming gas atmosphere for bright annealing of tube parts.

**RHODIUM PLATING** provides a hard, brilliant white, non-tarnishable surface extremely resistant to corrosive conditions.

**DEOXO® PURIDRYER** produces extremely pure, dry hydrogen with a dew-point of better than -100°F, with no inert gas purging necessary.

**BAKER PRECIOUS METALS**

**BAKER & CO., INC.**

113 ASTOR STREET, NEWARK 2, NEW JERSEY  
NEW YORK • SAN FRANCISCO • LOS ANGELES • CHICAGO

**ENGELHARD INDUSTRIES**

RESEARCH MAINTAINS BAKER'S LEADERSHIP IN PRECIOUS METALS



*S.S. White*  
 Flexible Shafts  
 Withstand  
 Temperature  
 Extremes!

A leading aircraft manufacturer has used S.S. WHITE flexible shafts for many years to transmit control between this graduated dial and aircraft thermostat. He finds that under any kind of temperature conditions, there is no measurable variation in torque to turn the shaft, or in torsional deflection required to initiate cam movement over the temperature range!

This ability to withstand temperature extremes is only one of the many remote control and power drive advantages industry has discovered in S.S. WHITE flexible shafts. Perhaps they can help you to simplify control or product design . . . cut your production costs . . . speed assembly. These quality shafts range from small to large sizes, and up to 12 feet in length. The assistance of our engineering staff in helping you work out a flexible shaft application for your product is yours for the asking. Just write to

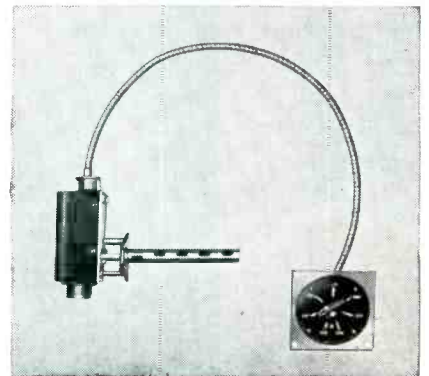

*S.S. White*

FIRST NAME

IN FLEXIBLE SHAFTS



*USEFUL DATA on how to select and apply flexible shafts. Write for Bulletin 5601.*

S. S. White Industrial Division, Dept. D, 10 East 40th St., New York 16, N. Y. Western Office: 1839 West Pico Blvd., Los Angeles 6, Calif.

Centralab  
1922 1957

35  
YEARS

Since 1922, industry's  
No. 1 source of  
standard and special  
electronic components

### VARIABLE RESISTORS

Miniature



Radio and TV



Transistor Circuits



Wirewound



Military



### ELECTRONIC SWITCHES

Miniature Rotary



Rotary-Action Flat



Rotary Power



Lever-Action



Slide



### TRANSISTOR AMPLIFIERS

Single-stage



Four-stage



Continued  
on next page . . .

# Centralab can put your variable resistance problems on

# ICE



This quality  
construction - I.C.E. -  
is now featured in these  
Centralab Radiohms®



**MODEL 3 RADIOHM®**  
Standard or locking bushing; ¼  
watt; 1000 ohms to 2.5 megohms.  
Meets MIL-R-94 specifications.



**MODEL 6 RADIOHM®**  
Plain or switch type; 1/10 watt;  
500 ohms to 10 megohms. Dia.,  
.502". Wide range of values and  
tapers.



**MODEL 1 RADIOHM®**  
Switch or plain type; 1/10 watt;  
500 ohms to 10 megohms. Dia.,  
.625". Seven standard tapers.

## Centralab's exclusive **Interfused Composition Element**

offers these advantages:

- Exceptional wattage dissipation
- Low moisture absorption
- Voltage and temperature stability
- Smooth electrical curve
- Noise-free performance
- Proven load-life reliability

Write for free technical bulletins.

# Centralab

A DIVISION OF GLOBE-UNION INC.  
914 EAST KEEFE AVENUE • MILWAUKEE 1, WISCONSIN  
IN CANADA: 804 MT. PLEASANT RD. • TORONTO, ONTARIO  
Circle 150 Reader Service Card

# stays cool when the heat's on

## Centralab's Model 3 Radiohm® now with I.C.E.\*

The Centralab Model 3 Radiohm, with its exclusive \**Interfused Composition Element*, provides unbelievable wattage dissipation, yet is smaller than a dime.

This miniature rotary potentiometer, with its rugged element, is ideally suited for high-temperature operations in both commercial and military applications.

Advanced design features offer you both standard and locking-type bushings. Each is available with sealed construction to meet today's demand for a unit that can be potted.

For immediate delivery in ratings from 1,000 ohms to 2.5 megohms, ask your local Centralab distributor for the JP and JL series.

typical  
watt-hour  
rating

Only 10% maximum resistance change, when used at . . .

- 1 watt for 1-1/2 hours
- 3/4 watt for 35 hours
- 1/2 watt for 80 hours
- 1/3 watt for 300 hours
- 1/4 watt, continuous rating

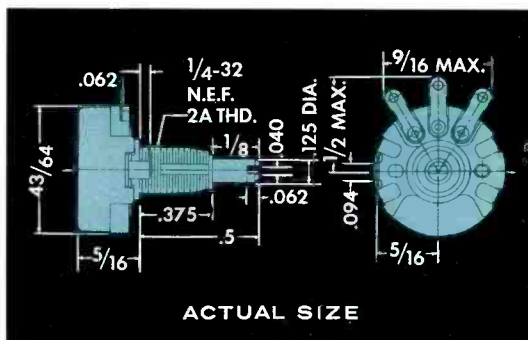
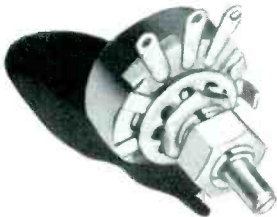

Write today for  
Technical Bulletin EP-63,  
for complete engineering data

Centralab  
CRL

A DIVISION OF  
GLOBE-UNION INC.

914 E. Keefe Ave.  
Milwaukee 1, Wis.

In Canada:  
804 Mt. Pleasant Road  
Toronto, Ontario

Circle 151 Reader Service Card

### CERAMIC CAPACITORS

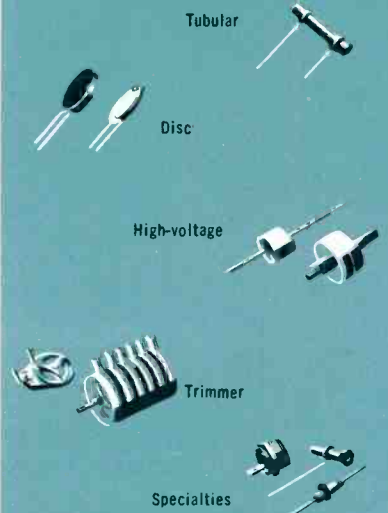

### PACKAGED ELECTRONIC CIRCUITS

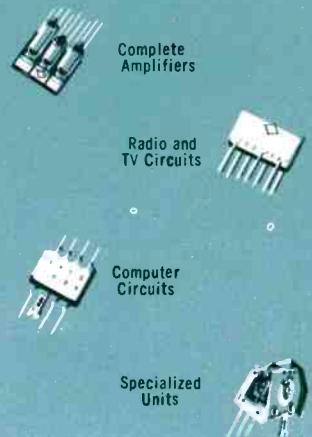

### ENGINEERED CERAMICS

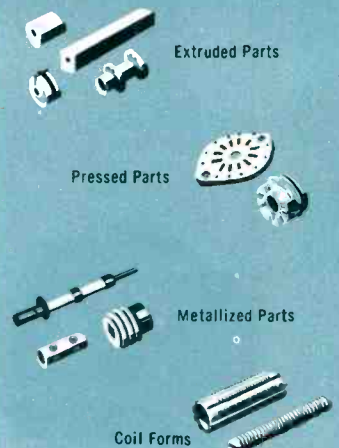

Hundreds of standard components are carried in stock by your nearby Centralab distributors.

Discuss your special requirements with the Centralab representative.

# A.C. Ratiometer

*...accurate to five parts per million!*

REFERENCED TO UNITY RATIO

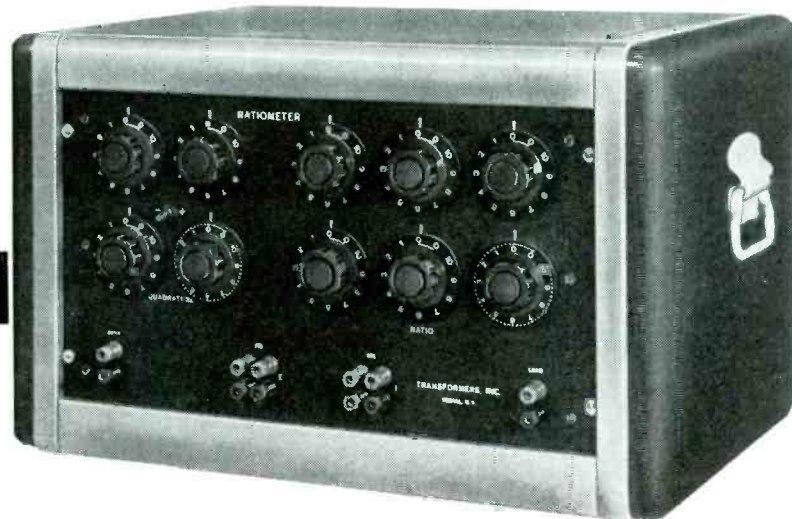

The Transformers, Inc. Ratiometer is a precision instrument to measure any voltage ratio from 0.000001 to 1.111111. Transformer ratios can be accurately measured at "no load" and under full load. Two models are available:

**MODEL 204** is designed for use between 200 cps and 2,000 cps. It is supplied with plug-in units for 400 cps operation.

**MODEL 206** is designed for use between 40 cps and 1,000 cps. It is supplied with plug-in units for 60 cps operation.

Plug-in units for any other frequency are supplied to order.

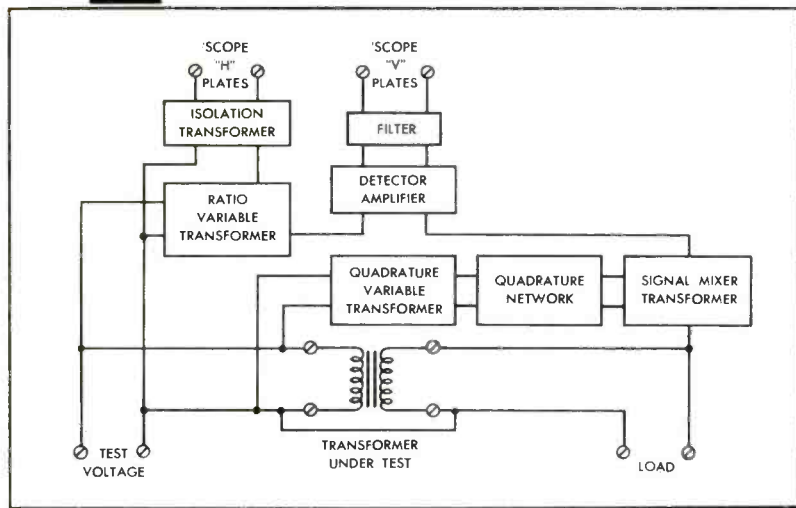

The Ratiometer consists of two precision variable transformers, a calibrated quadrature injector, a filter, and a pre-amplifier. Block diagram indicates connections of the various components within the instrument.

For additional information, ask for Bulletin #204

## TRANSFORMERS, INCORPORATED

200 Stage Road, Vestal, N.Y.

### ACCURACY

Five parts per million referenced to unity ratio.

### MAXIMUM VOLTAGE

<b>Model 204</b>	120 V	200 cps
	180 V	300 cps
	240 V	400 cps and over
<b>Model 206</b>	80 V	40 cps
	120 V	60 cps
	240 V	120 cps and over

### PRICE

Model 204 Ratiometer, complete with 400 cps plug-in filter and quadrature units **\$865**

Model 206 Ratiometer, complete with 60 cps plug-in filter and quadrature units **\$1235**



## SMALL...SELF-CONTAINED...10 MC CAPACITY!

- Frequency measurements at 0.1 v rms over 0 cps—10 mc, without heterodyning or plug-ins
- 10 operating functions and three input channels for maximum application flexibility
- 7-place direct digital readout—no meter indicators
- Priced at only \$1975.00

### *Beckman/Berkeley Model 7370 Universal EPUT® and Timer*

#### BRIEF SPECIFICATIONS

##### *Model 7370*

##### Functions:

E/UT, E/UT × 10, SCAN, COUNT, TIM,  
PER, PER × 10, E/B, E/B × 10,  
E/B-A, (TEST)

##### Ranges:

Frequency: 0 cps to 10 mc  
Period: 0 cps to 3 mc  
Time Interval: 0.3 μsec to 10<sup>7</sup> sec  
Ratio: 1 to 10<sup>7</sup> from 10 cps to 10 mc

##### Time Bases:

0.1 μsec to 10 sec in decade steps

##### Accuracy:

±1 count ± oscillator stability

##### Oscillator Stability:

3 parts in 10<sup>7</sup> per week

##### Price:

\$1975.00 F. O. B. Richmond, California

Developed specifically to meet the test instrumentation needs of today Model 7370 is a completely self-contained precision instrument capable of handling a broad range of frequency, frequency ratio, and time interval measurements easily, dependably and with extreme accuracy. The most modern counter-timer obtainable, it features three input channels for greater application flexibility; field-proved components; advanced circuitry; modular chassis construction; binary coded output from all DCU's for driving auxiliary equipment such as a digital recorder.

Half the size of conventional instruments of its type, Model 7370 weighs only 62 pounds. Input impedance is 1 megohm; available output frequencies, 1 cps to 1 mc; accuracy, ±1 count. Built-in self-test facility checks correct operation of all frequency dividers and DCU's. Optional Standard Modifications, including provision for flow meter input, expand the laboratory and in-plant utility. Controls are functional, and so simple that non-technical personnel can be readily trained in their use.

Complete technical details on the Beckman/Berkeley Model 7370 Universal EPUT and Timer are available on request. Write to Department G12

## Beckman®

*Berkeley Division*

2200 Wright Avenue, Richmond 3, California

a division of Beckman Instruments, Inc.

## Another NEW CLARE PLANT to give you relays of unequalled quality

- Telephone type relays (ac and dc)
- Hermetically sealed relays
- Computer relays
- Video relays
- Power relays
- Mercury-wetted contact relays
- Relay banks
- Plate circuit relays
- Stepping switches
- Lever, push and turn keys
- Other special relays

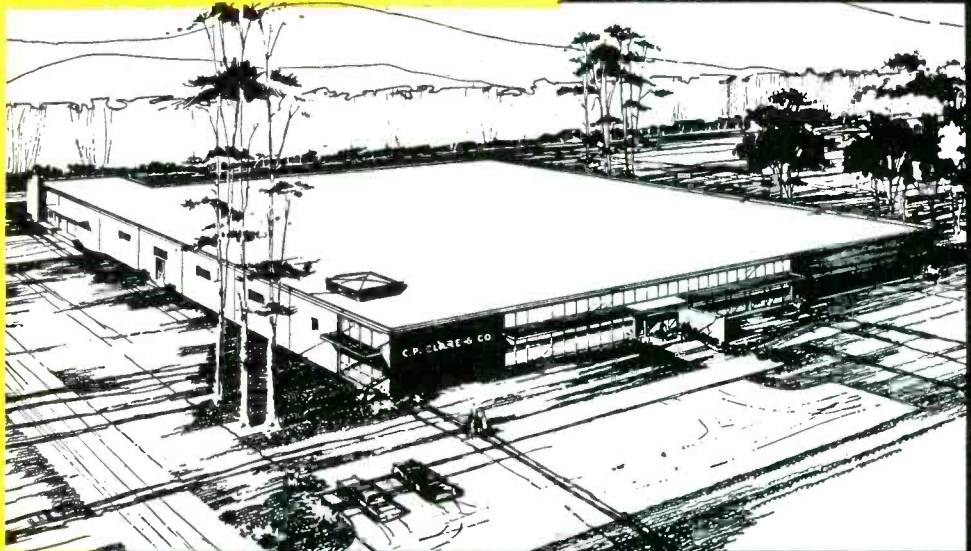

New C. P. Clare & Co. plant at Fairview, N. C. will expand manufacturing facilities which have been under way in Fairview for two years.

Before midyear 1958 CLARE will be serving customers from a new factory at Fairview, N. C.—a facility that will match the manufacturing advantages of our Chicago plant, itself only five years old.

This CLARE expansion is made necessary by the tremendous growth of the electronics industry and the increasing demand for precise components, including relays whose life can be measured in billions of operations.

Facilities of virtually clinical cleanliness are required for this kind of precision. That's why CLARE plants in both

Chicago and Fairview maintain complete control of the temperature, humidity and cleanliness of the air . . . immaculate walls and floors . . . powerful, shadowless lights, for assembly of small parts.

If yours is a product whose long life, reliable performance and freedom from maintenance depends on relays, it will pay you to know ALL about CLARE relays. C. P. Clare & Co., 3101 Pratt Blvd., Chicago 45, Illinois. In Canada: C. P. Clare Canada Ltd., 2700 Jane Street, Toronto 15, Ontario. Cable Address: CLARELAY

# CLARE RELAYS

FIRST in the industrial field

# VERSATILE

Multi-channel—telegraph A1 or telephone A3

# STABLE

High stability (.003%) under normal operating conditions

# RUGGED

Components conservatively rated. Completely tropicalized



FROM GROUND TO AIR OR POINT TO POINT

Here's the ideal general-purpose high frequency transmitter! Model 446, suitable for point-to-point or ground-to-air communication. Can be remotely located from operating position. Coaxial fittings to accept frequency shift signals.

This transmitter operates on 4 crystal-controlled frequencies (plus 2 closely spaced frequencies) in the band 2.5-24.0 Mcs (1.6-2.5 Mcs available). Operates on one frequency at a time; channeling time 2 seconds. Carrier power 350 watts, A1 or A3. Stability .003%. Nominal 220 volt, 50/60 cycle supply. Conservatively rated, sturdily constructed. Complete technical data on request.

Now! Complete-package, 192 channel, H.F., 75 lb. airborne communications equipment by Aer-O-Com! Write us today for details!

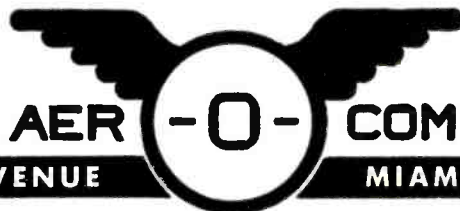

3090 S. W. 37th AVENUE

MIAMI 33, FLORIDA

A-131



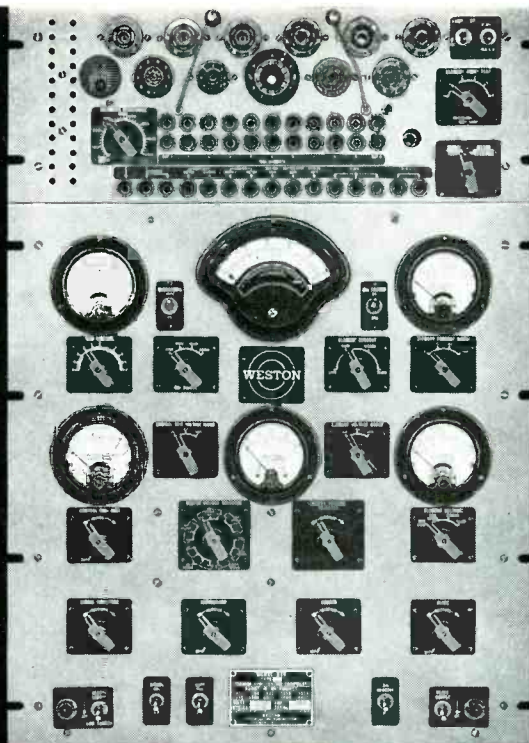

## LABORATORY MODEL (686)

- A true mutual conductance analyzer that tests tubes under actual circuit operating potentials. Overall GM accuracy is 3% or better.
- Transconductance is measured directly without need for null adjustments or corrections, providing GM readings on all receiving type tubes.
- Circuit is mathematically calibrated and requires no calibrated tubes for GM circuit standardization.
- A real laboratory for electron tubes, Model 686 is entirely self-contained, with a filtered d-c power source, special circuitry to keep meter loading effects negligible, and a well regulated grid bias supply.

# Tube Analyzers

by **WESTON**

## PORTABLE MODEL (981)

- Filtered d-c potentials provide better GM accuracy.
- Voltage divider network for better grid bias settings.
- Four signal levels provided protect against excessive grid current surges.
- Provision for tube interelectrode leakage measurements as high as 10 megohms.



Whether for production quality control . . . laboratory analysis of tube characteristics . . . or quick accurate servicing of electronic equipment, WESTON tubecheckers are acknowledged leaders for accuracy, time-saving facility, and long term dependability. These and other Weston test instruments are available through leading distributors. Bulletin available by writing WESTON INSTRUMENTS, Division of DAYSTROM, INC., 614 Frelinghuysen Avenue, Newark 12, New Jersey.

**WESTON**  
**TEST EQUIPMENT**



# **HYFEN**

## **a big step toward automation of wiring harnesses**

**Crimped  
pins and  
sockets  
snap-locked  
in plug  
or receptacle.  
Individual circuit  
removal or  
gang disconnect.**

Hyfen ends the need for time consuming solder operations — and the high rejection rate inherent with solder.

Pins and sockets are speedily crimped on wire ends by automatic installation tooling — or where more convenient, by bench or hand tools. Dies control and provide a uniform depth of indent which can be inspected by depth micrometer assuring absolute unvarying reliability. Crimping may be done before or after harness is in place.

Hyfen meets or exceeds MIL specifications for voltage drop, dielectric strength, contact engaging force, and contact retention force. It provides high corrosion resistance since there are no fluxes or dissimilar metals involved. Floating contacts in both plug and receptacle make for uniform mating and disconnecting force by the alignment flexibility provided.

Hyfen principle is not limited as to size, shape of plug and receptacle nor to number or size of connections.

Wire for bulletin.

Burndy, Norwalk, Connect.—Scarboro, Canada

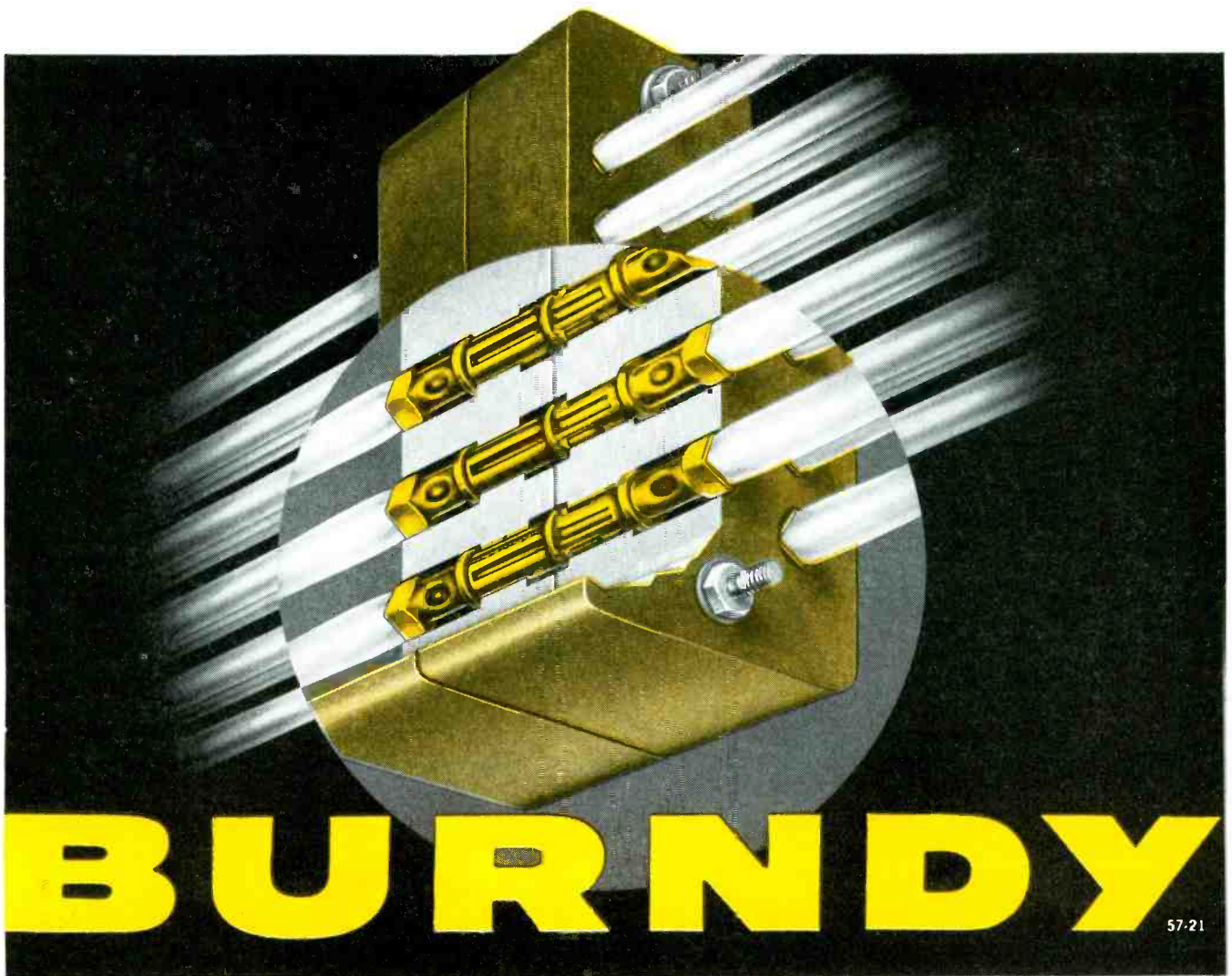

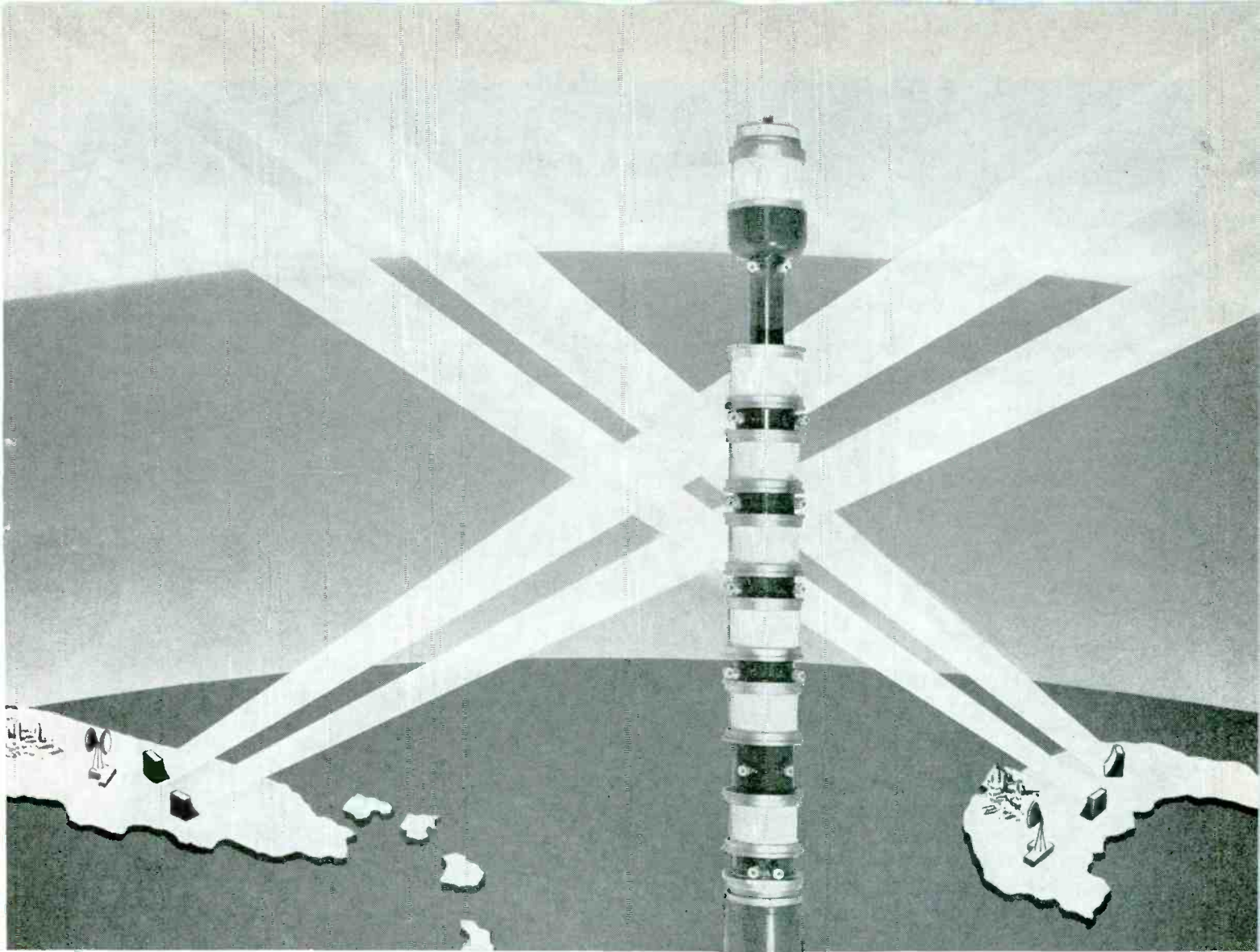

## EIMAC klystron powers Florida-Cuba tropospheric bridge

Federal Telecommunication Laboratories O/H tropospheric equipment built for American Telephone and Telegraph Company and International Telephone and Telegraph Company spans the gap between Florida and Cuba, transmitting TV programs simultaneously with multi-channel telephone service.

Each site of this joint A. T. & T. and I. T. & T. system employs two transmitters and four receivers to obtain space and frequency diversity. Radio equipment has sufficient band

width to handle a television program and 120 or more telephone messages.

In the final amplifier of the FTL 12-1 System, engineers specified the Eimac 6K50,000LQ. This six cavity water cooled klystron delivers 10 kw rf output power in FTL equipment with a power gain of 1000 times and band widths to 20 mc.

Another in a series of advertisements on the extensive use of Eimac klystrons in tropo-scatter systems.

**EITEL-McCULLOUGH, INC.**  
SAN BRUNO - CALIFORNIA

*Eimac First for high-power amplifier klystrons.*



### 6K50,000LQ KLYSTRON AMPLIFIER

#### Electrical

Power Output.....10 KW CW  
Frequency Range.....720-980 Mc.  
Gain.....Greater than 50 db. (Narrow band)  
Beam Voltage.....16 KV DC  
Beam Current.....1.62 Amps

#### Mechanical

Cathode.....Bombarded  
Number of Cavities.....Six  
Overall Length.....58"  
Outside Diameter.....5"  
RF circuitry including tube......26" diameter x 61" high

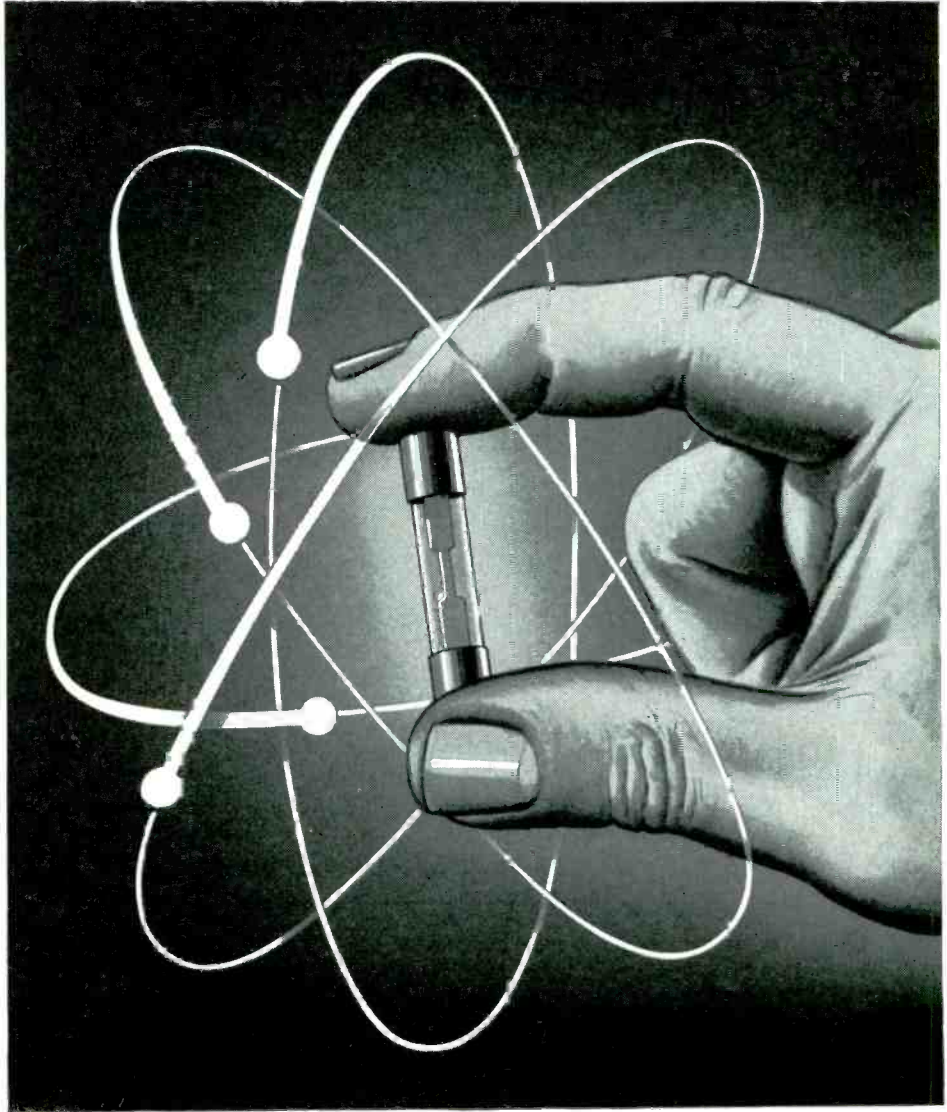

## ELECTRONICALLY TESTED BUSS FUSES *can help safeguard you against troubles and complaints*

With BUSS fuses, dependable electrical protection is not left to chance. Every BUSS fuse is tested in a sensitive electronic device that automatically rejects any fuse not correctly calibrated, properly constructed and right in all physical dimensions.

As a result, when you specify BUSS fuses you are sure the fuse will operate properly under all service conditions. You avoid 'kicks' or complaints from users about faulty fuses failing to

protect or causing needless shutdowns.

By their unfailing dependability, BUSS fuses help you safeguard the reputation of your equipment for quality and reliability.

**Should you have an unusual problem  
in electrical protection . . .**

. . . the BUSS fuse engineers are at your service — and in many cases can save you engineering time by helping you choose the right fuse for the job. Whenever possible, the fuse selected

will be available in local wholesalers' stocks, so that your device can be serviced easily.

For more information on BUSS and FUSETRON Small Dimension fuses and fuseholders . . . Write for bulletin SFB. Bussmann Mfg. Division McGraw-Edison Co., University at Jefferson, St. Louis 7, Mo.

***BUSS fuses are made to protect — not to blow, needlessly***

1227



MAKERS OF A COMPLETE LINE OF FUSES FOR HOME, FARM, COMMERCIAL, ELECTRONIC, AUTOMOTIVE AND INDUSTRIAL USE.

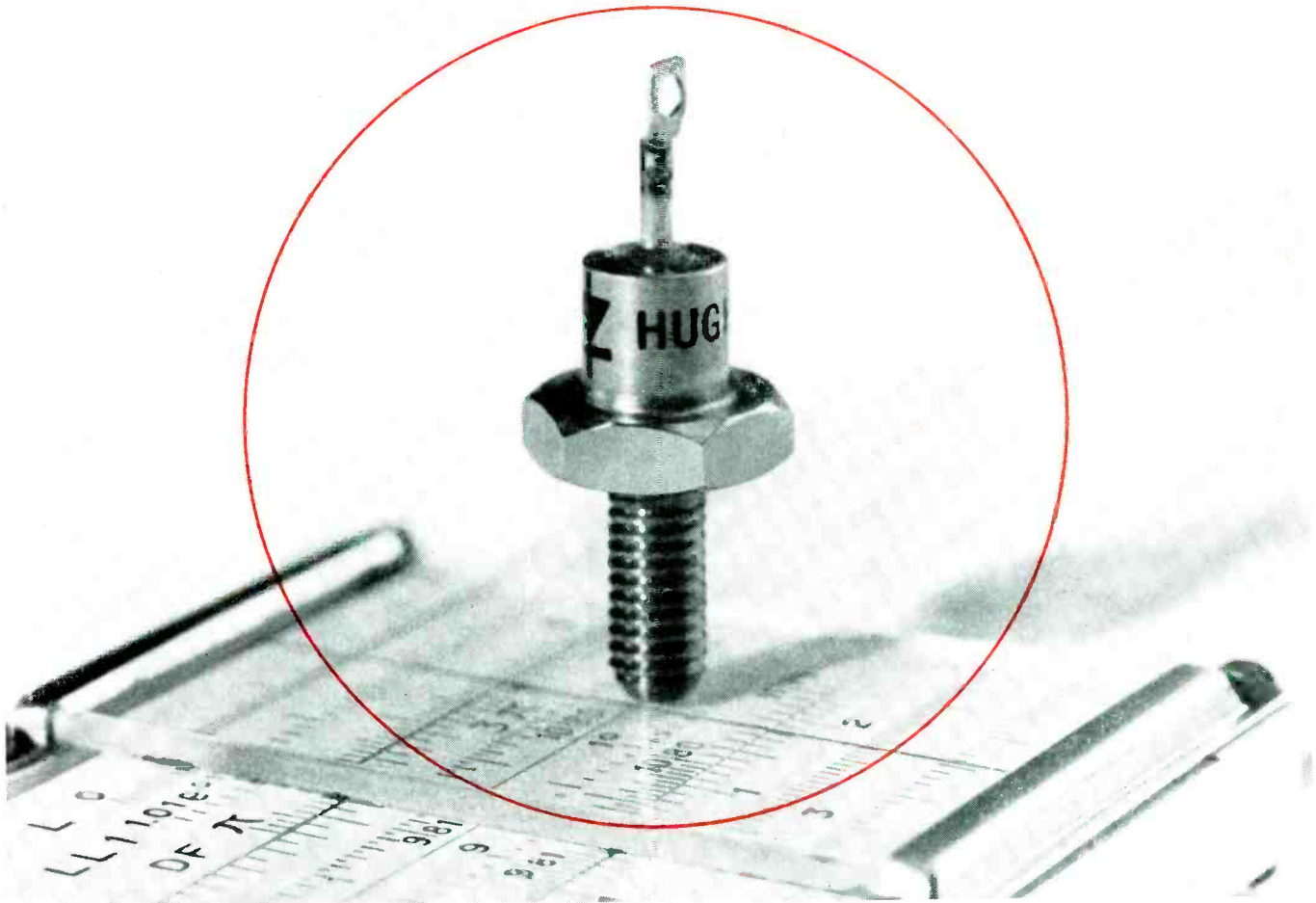

## announcing a new Hughes series — high efficiency, medium power silicon rectifiers

For the first time, you can obtain high forward conductance and a high breakdown voltage, together in one rectifier. High forward conductance increases the efficiency of the rectifier, thereby providing *more* power to the load at lower junction temperatures. And low junction temperatures ensure long life plus reliable rectifier operation.

The unique combination of high forward conductance and high breakdown voltage permits rectifier performance never before achieved in the standard EIA Group 20 (7/16" hex.) stud mounted package. This package is welded and hermetically sealed with a glass-to-metal seal to provide complete protection from contamination and moisture penetration. Inside, where it counts, protection like this is essential.

The **HR10681**, a typical rectifier in the series.

Min. Breakdown Voltage	= 600V
Max. Average Rectified Current @ 25°C	= 2A*
Average Reverse Leakage Current @ 2A and 420V <sub>rms</sub> @ 25°C	≅ 100 <sub>μ</sub> A
Typical Full Load Average Forward Voltage Drop	≅ 1.0V
Typical Dynamic Forward Resistance	≅ 0.2ohm

\*Higher currents obtainable with heat sink.



actual size

*Our sales engineers welcome the opportunity to discuss application of these new units to your circuitry. For address of sales office nearest you, or for complete information, write:*

SEMICONDUCTOR DIVISION • HUGHES AIRCRAFT CO.  
 International Airport Station, Los Angeles 45, California

*Creating a new world with ELECTRONICS*

**HUGHES PRODUCTS**

© 1957, HUGHES AIRCRAFT COMPANY

HUGHES



SEMICONDUCTORS

# NEW!

## thinnest pushbutton switch

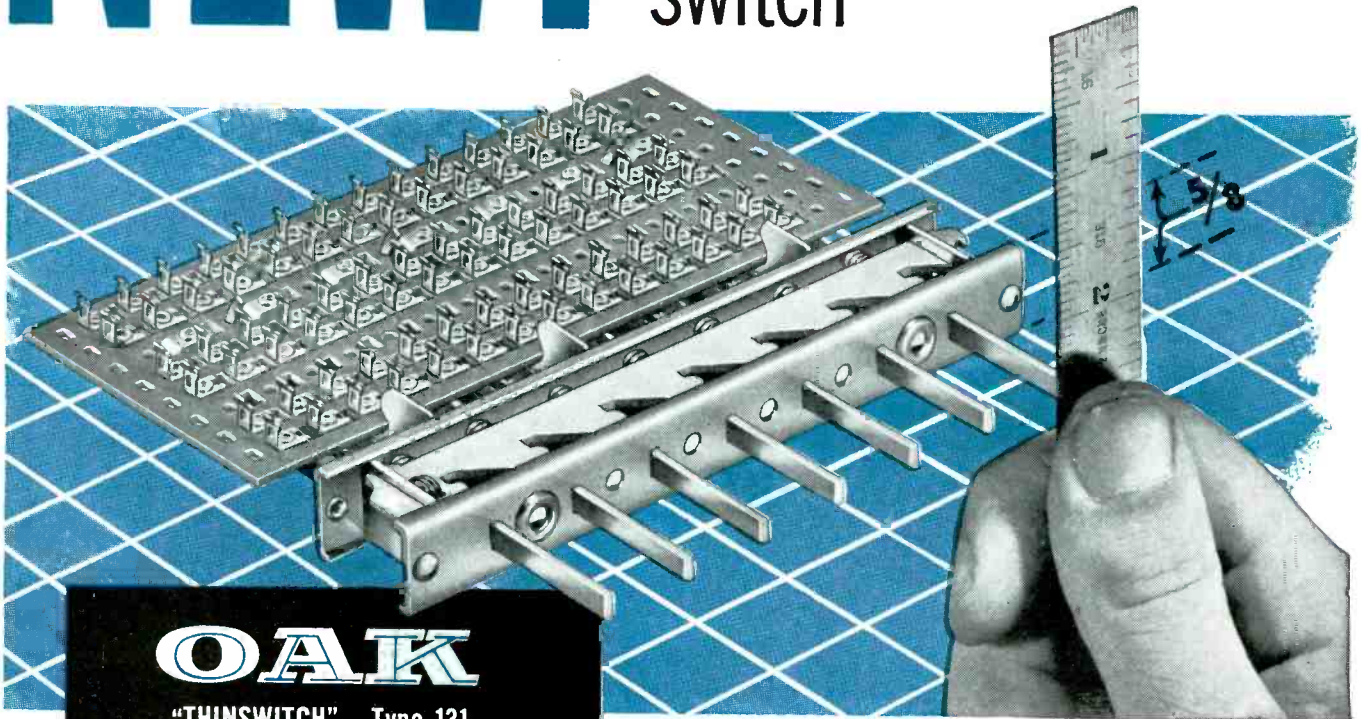

### OAK

"THINSWITCH" Type 131

#### FEATURES

- Measures only  $\frac{5}{8}$ " thick.
- 1 to 12 buttons, standard, with  $\frac{5}{8}$ " spacing.
- Up to 14 contacts per button.
- "Floating" slider design for smooth, easy operation.
- Famous Oak double-wiping contacts.
- Highest grade phenolic punching stock.

#### REQUIRES 45% LESS PANEL AREA!

This new Oak switch is particularly valuable as a spacesaver in keyboards handling complicated, low-current circuits. The Type 131 can be mounted side by side on  $\frac{1}{16}$ " centers, so that a bank of 10 switches, for example, requires only  $6\frac{13}{16}$ ".

Thus, in equipment such as computers, testers, automatic coin devices, and communications gear, the Type 131 offers extra flexibility in laying out panel areas, or actually permits a decrease in the size of the equipment.

Type 131 switches are built to your exact requirements with the same high quality materials and workmanship as other Oak switches. Call in your Oak representative, or write for full technical details.



SWITCHES



ROTARY  
SOLENOIDS



CHOPPERS



VIBRATORS

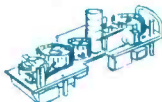

SUBASSEMBLIES

### OAK

MFG.  
CO.



1260 Clybourn Ave., Dept. G, Chicago 10, Illinois  
Phone: MOhawk 4-2222

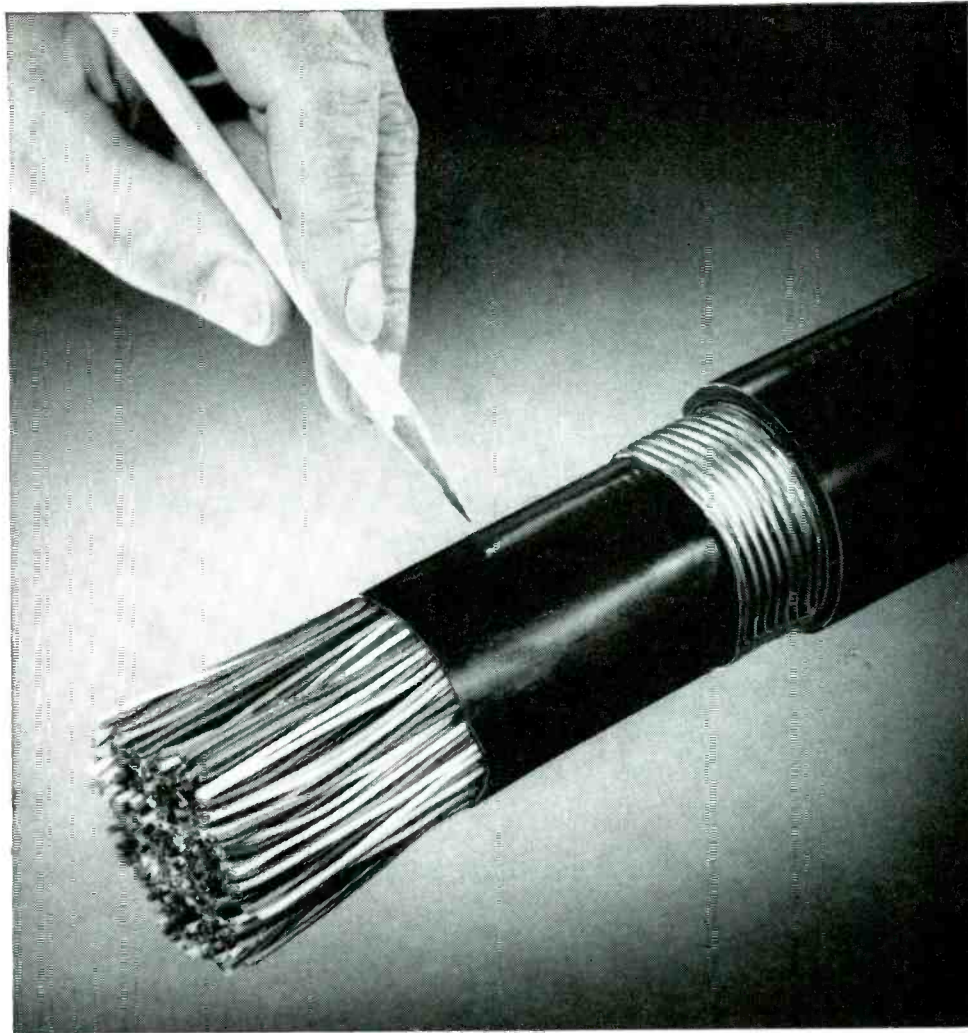

**"MYLAR"** offers a unique combination of properties valuable for electrical design

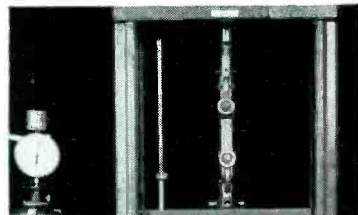

**HIGH TENSILE STRENGTH.** "Mylar" is the strongest plastic film. Instron tester shows an average strength of 20,000 lbs. psi.

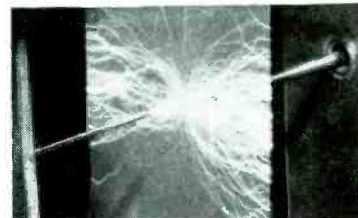

**HIGH DIELECTRIC STRENGTH.** Average of 4,000 volts per mil . . . average power factor of 0.003 to 60 cycles . . . dielectric constant above 3.0 at 72°F., 1,000 cycles.

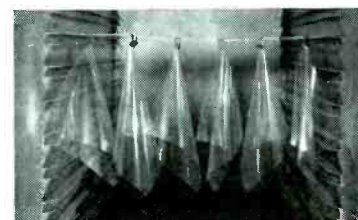

**THERMAL STABILITY.** "Mylar" has an effective operating range from -80° to 300°F. . . won't become brittle with age.

## Core binder tape made with Du Pont MYLAR<sup>®</sup> helps Western Electric speed production of communication cable

**PROBLEM:** Western Electric's new long-life, high-dielectric communications cable posed a challenging problem for production engineers. The problem was this—how to efficiently extrude an outer jacket of polyethylene without fusing the inner pairs of wires also coated with polyethylene.

**SOLUTION:** After extensive tests with

combinations of materials, a tape of Du Pont "Mylar"\* polyester film and rubber was selected to act as a heat barrier.

**RESULTS:** Western Electric reports that abrasion-resistant "Mylar", with its hard, durable surface, helps the core binder tape run smoothly on its equipment without snagging or tearing. Because of its high tensile strength and melting point, "Mylar" helps prevent corrugations of the

electrostatic aluminum shield from breaking through the tape and shorting the cable.

**HOW CAN "MYLAR" HELP YOU?** Whether you make guided missiles or tiny components, you may be able to capitalize on the outstanding combination of properties found in tough, transparent "Mylar" film. For a booklet containing technical data plus information on successful applications, send in the coupon below.



BETTER THINGS FOR BETTER LIVING  
... THROUGH CHEMISTRY

**DU PONT**  
**MYLAR<sup>®</sup>**  
POLYESTER FILM

\*"MYLAR" is Du Pont's registered trademark for its brand of polyester film.

E. I. du Pont de Nemours & Co. (Inc.)  
Film Dept., Room E-12, Nemours Bldg., Wilmington 98, Del.  
Please send the new booklet listing properties, applications and types of "Mylar" polyester film available (MB-11).

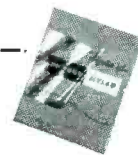

Application \_\_\_\_\_  
Name \_\_\_\_\_ Title \_\_\_\_\_  
Company \_\_\_\_\_  
Address \_\_\_\_\_  
City \_\_\_\_\_ State \_\_\_\_\_

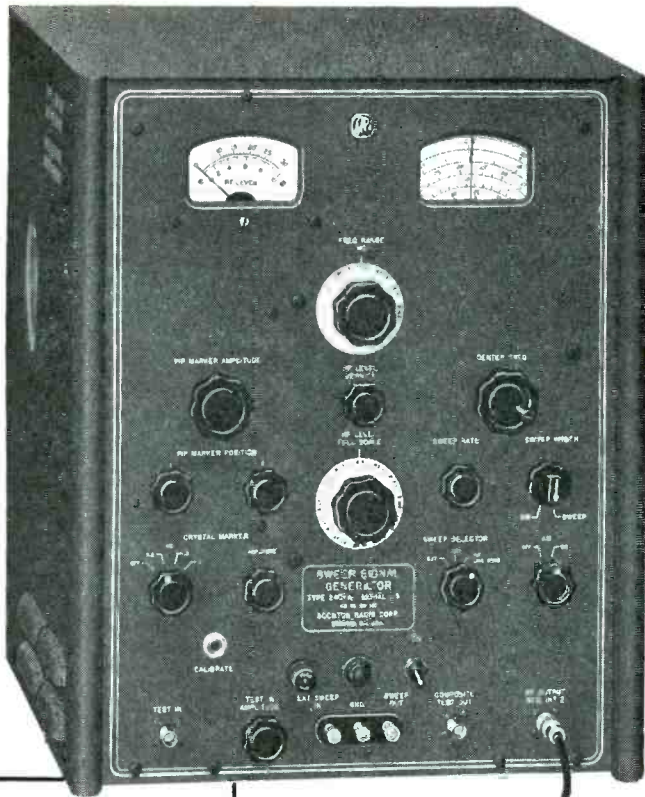

**SWEEP SIGNAL GENERATOR  
TYPE 240-A**

PRICE: \$1585.00 f.o.b. Boonton, N. J.

In this one instrument —

**A SWEEPING, CW, and AM  
SIGNAL GENERATOR**  
with Crystal-controlled Markers  
**4.5 mc to 120 mc**

**FEATURES:**

- All-electronic, AGC-controlled, constant amplitude, variable width linear frequency sweep.
- Extremely low leakage — can be used down to 0.1 microvolt.
- RF output level accurately monitored on both CW and sweep.
- Basic frequency accuracy of  $\pm 1\%$  — can be standardized against internal crystal to  $\pm 0.005\%$ .
- Internal crystal and pip interpolation markers.
- Markers do not pass through system under test — internal mixer adds frequency identification to system output.

**SPECIFICATIONS**

**RF FREQUENCY RANGE:** 4.5 to 120 mc continuously variable in five ranges accurate to  $\pm 1\%$ .

**RF OUTPUT VOLTAGE:** 1.0 to 300,000 microvolts continuously variable as swept frequency generator — same except 100,000 microvolts maximum on CW accurate to approximately  $\pm 10\%$  of full-scale "RF Level" meter readings.

**AM MODULATION:** Factory adjusted to 30% from internal 1000 cps oscillator.

**RANGE OF SWEEP WIDTH:** Continuously variable from  $\pm 1\%$  of center frequency to  $\pm 15$  mc or  $\pm 30\%$  of center frequency, whichever is smaller.

**LINEARITY OF SWEEP RF FREQUENCY:** Within 10% over middle 80% of sweep excursion, within 20% over remainder.

**FLATNESS OF SWEEP RF OUTPUT:** Better than 7% while sweeping for any combination of output, center frequency, and sweep width.

**MARKER CHARACTERISTICS:** Crystal birdie type markers switchable to spacing of 0.1, 0.5, or 2.5 mc accurate to  $\pm 0.005\%$ . Two stable pip type markers adjustable to any position on the internal sweep excursion.

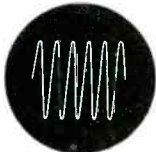

CW Output 4.5 to 120 mc



AM Modulated CW  
30% at 1000 cps

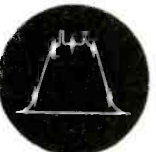

Broad Band Sweep  
 $\pm 1\%$  to  $\pm 30\%$  of  
center frequency





# PRESSURIZING AVIONIC SYSTEMS

Eastern pressurization equipment protects vital electronic gear. A continual program of research and development creates customized pressurization units that keep the performance of avionic systems unaffected by altitude and ambient conditions. Custom units that meet military specifications help to solve your problems when recommending electronic components.

When you have a challenging problem to prevent pressure, or heat, or moisture, or dust from affecting electronic performance, come to Eastern for complete and creative engineering help.

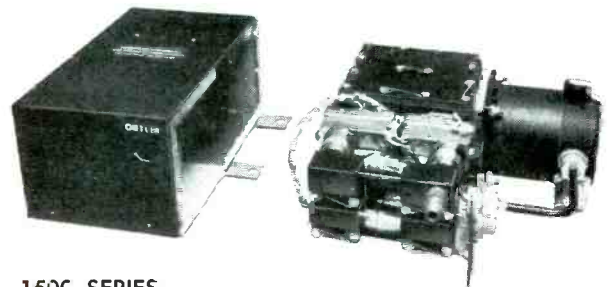

150C SERIES  
PRESSURIZATION UNIT



100 SERIES  
PRESSURIZATION UNIT

## EASTERN PRESSURIZATION UNITS

A variety of capacities accommodates a broad range of requirements and meets appropriate government standards. Typical units operate from zero to over 70,000 feet at temperatures from  $-65^{\circ}\text{F}$  to  $+160^{\circ}\text{F}$ . Delivery: 0-3600 cu. in./min. free delivery, Discharge Pressure: 0-60 p.s.i. Standard sub-assemblies and components normally are used to create a custom-made design to fit your exact needs. Units may consist of an air pump and motor assembly, pressure switch, check valve, tank valve, terminal connectors, and dehydrator.

Write for Eastern AVIONICS BULLETIN 340



# EASTERN

## INDUSTRIES, INC.

100 Skiff St., Hamden 14, Conn.

West Coast Office: 1608 Centinela Avenue  
Inglewood 3, California — Phone ORegon 8-3958

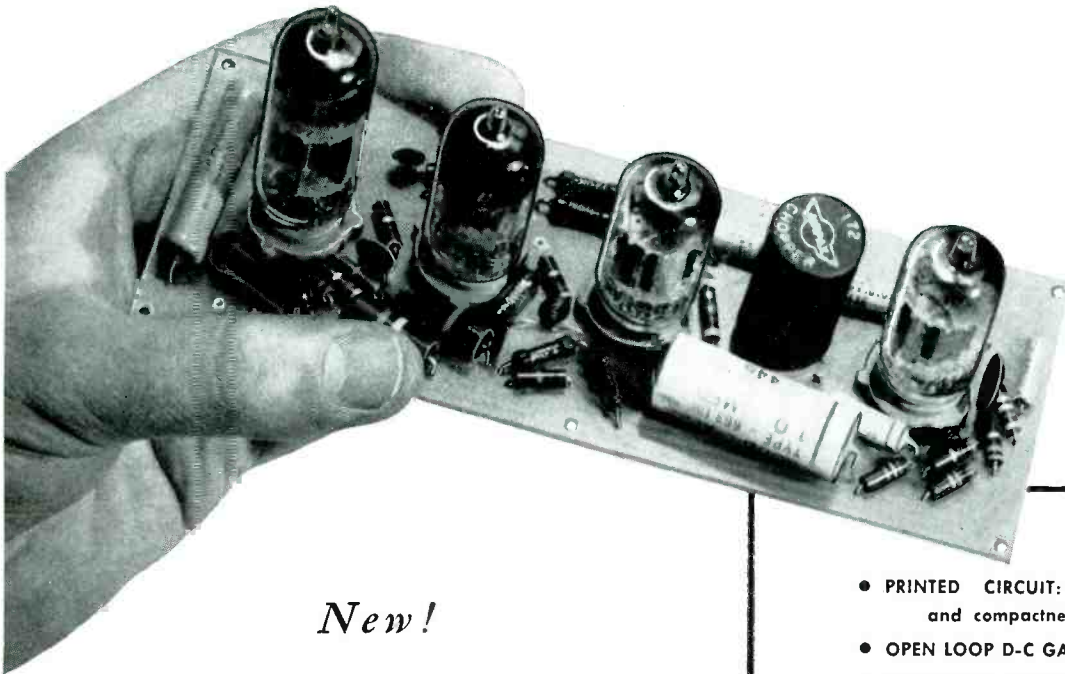

*New!*

*Greater System Accuracy  
and Reliability with the*

- PRINTED CIRCUIT: Economy, reliability and compactness.
- OPEN LOOP D-C GAIN: 10 million.
- LONG TERM DRIFT, NOISE and OFFSET: under 100 microvolts.
- OUTPUT VOLTAGE RANGE:  $\pm 115$  volts.
- SIZE: 7" x 2½" board.
- MOUNTING: Any convenient method.
- PRICE: \$95.00.

## PHILBRICK PRINTED CIRCUIT AMPLIFIER

### *Model USA-3*

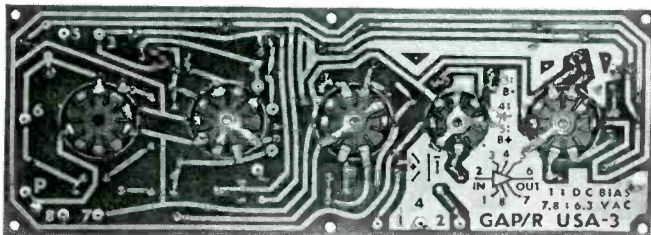

Underside of Model USA-3 showing printed circuit, amplifier connection scheme, and connecting terminals.

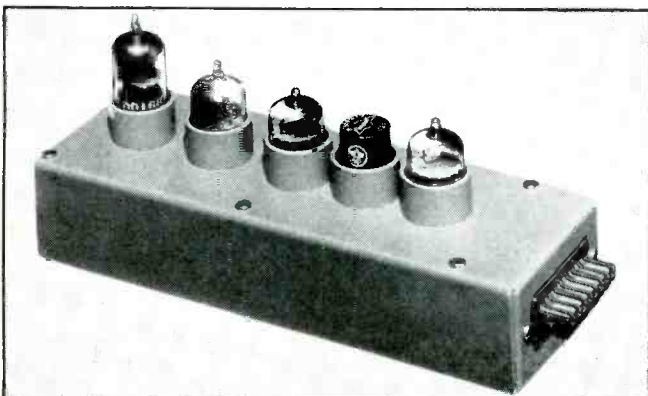

Model USA-3 showing one of the several types of modular packaging available at extra cost.

High performance combined with the reliability and compactness of a printed circuit design are featured in the new Philbrick Universal Stabilized Amplifier, Model USA-3. It is ideally suited for applications to instrumentation, control and analog computation. Extremely high open-loop d-c gain, wide bandwidth, low noise and wide output range are important performance characteristics of this new chopper stabilized amplifier. An interesting design feature makes this instrument safe against self-destruction, even under prolonged overload conditions or direct grounding of its output. At a price of only \$95.00, it offers more performance per dollar than any other amplifier on the market today. Write to George A. Philbrick Researches, Inc., Dept. 14, for Bulletin USA-3.

GEORGE A.  
**PHILBRICK**  
RESEARCHES, INC.

230 Congress Street, Boston 10, Massachusetts

# electro-mechanical computer and control components by Librascope

## ANALOG-DIGITAL CONVERTERS



Most versatile line of shaft position to digital converters models for Gray, Binary, and Binary Coded Decimal Systems. Special models for sine-cosine read-out. Used in digital airborne controls, machine tool controls, or wherever position data must be translated into digital form.

*Ask for Catalog No. EI0-1*

## SINE-COSINE MECHANISM



Provides for instantaneous solution of problems involving the sine or cosine of an angular variable. Angular rotation is converted into a displacement proportional to sine or cosine of the input. Compact, simple, self-contained design.

*Ask for Catalog No. 304062*

## READ-RECORD HEADS

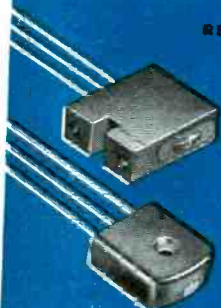

A complete line of Read-Record Heads for all types of magnetic drum memory systems. Simplicity of design, flexibility of operation, high reading signal and low current are basic characteristics of these read-record heads which are used where reliable performance is essential.

*Ask for latest Catalog*

## BALL DISC INTEGRATOR



A precision integrating mechanism for totalizing, rate determination, and differential analyzing. Can also be used as a closed loop servoelement for accurate variable speed drive. Small in size, rugged construction for long life; extreme precision.

*Ask for Catalog No. 304061*

## HOLLOW SHAFT DIFFERENTIAL



Four models of precision differentials for application to problems of angular sums, angular velocity sums or sequence operations. May be installed or removed without disassembly of unit or differential. High accuracy; unlimited displacement; small radial clearance. A time-tested design.

*Ask for latest information*

FOR MORE THAN 20 YEARS, Librascope has manufactured mechanical and electrical computers and components for military and commercial purposes.

Librascope products are designed for reliability, long-life, trouble-free performance.

If you have a problem concerning complete computer/control systems, contact Librascope.

Representatives in principal cities.



# LIBRASCOPE

LIBRASCOPE, INC., 808 WESTERN AVE., GLENDALE, CALIFORNIA

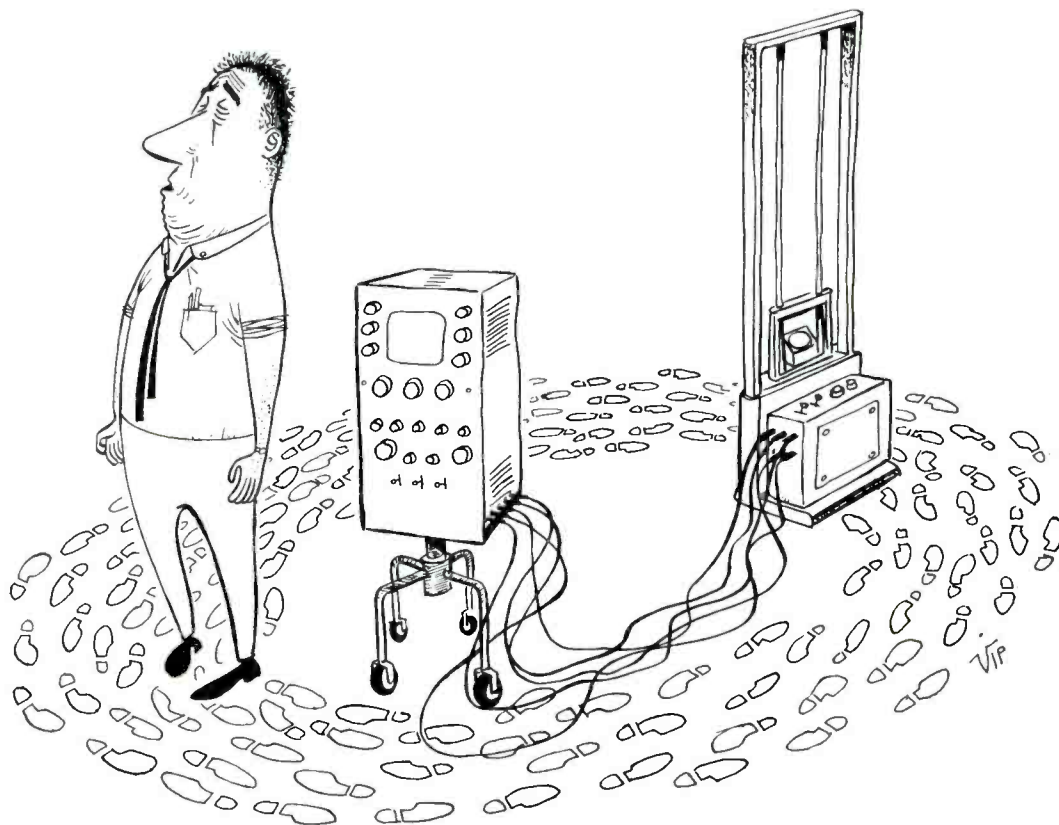

**PROBLEM:** Duplication of Research Effort

Even the most patient veteran researchers are often irked in attempting transient analysis using conventional scopes. Time and effort wasted in repetitious trial and error to "capture" transients can be a problem of first magnitude.

**SOLUTION:** Now you no longer need to put up with elusive traces. The answer to your time-duplication dilemma is the new Hughes **MEMO-SCOPE® Oscilloscope**. A storage type oscilloscope, it can instantly "freeze" any number of selected transients—retain single or successive displays brilliantly until intentionally erased.

**HUGHES MEMO-SCOPE OSCILLOSCOPE**

**STORAGE TUBE**—5-inch diameter Memotron® Direct Display Cathode Ray Storage Tube. Writing speed for storage: 125,000 inches per second. The optional Speed Enhancement Feature multiplies writing speed approximately four times.

**OPTIONAL PREAMPLIFIER EQUIPMENT**—High Sensitivity, Differential Input, Type HS/6: 1 millivolt to 50 volts per division. Dual Trace Type WB/DI/11: 10 millivolts to 50 volts per division. Four independent positions may be selected for single or double channel performance and chopped or alternate sweeps.

*You will want to see this "transient recorder with a memory" demonstrated. Send for Application Data Sheet No. MSAD-A3. and ask for a Hughes representative to arrange a demonstration in your company. Make request to:*

**HUGHES PRODUCTS MEMO-SCOPE Oscilloscope**  
International Airport Station, Los Angeles 45, California

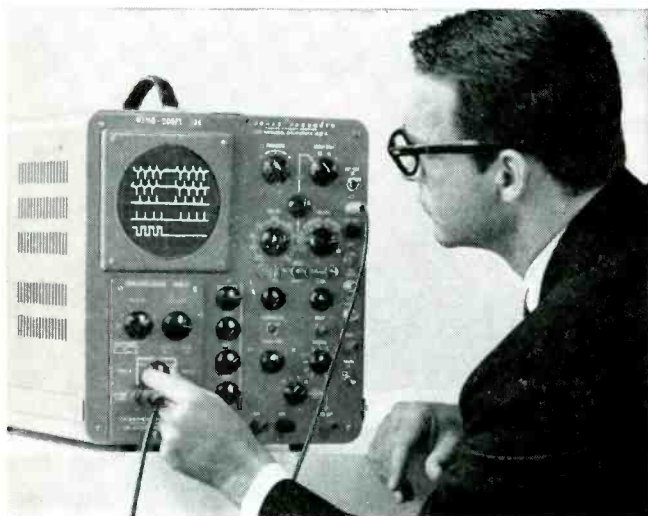

Creating a new world with **ELECTRONICS**

**HUGHES PRODUCTS**

**DOW CORNING  
CORPORATION**

# Silicone Dielectrics

ELECTRICAL AND ELECTRONIC NEWS No. 15

## Silicone Insulated Transformers Light-Weight, Maintenance Free

Added proof that you get "more power per pound" and maximum reliability with silicone electrical insulation is provided by Moloney Electric Company's new line of 3-phase, nitrogen filled, dry-type transformers.

Take the 1500 KVA rating, for example: these units weigh only 21,000 pounds and measure less than 9½ x 5½ x 10 feet. Silicone-insulated throughout, they can be safely installed almost anywhere regardless of high ambients, contaminated or dust laden atmospheres. In addition, these transformers are virtually maintenance-free; no liquids to maintain, no toxic fumes to guard against.

Contributing to the transformers' efficient performance are the strong, lightweight silicone-glass spacer bars laminated by Formica Company into U-shapes for maximum heat dissipation. Moloney also uses Formica's G-54 silicone-glass for phase barriers and layer insulation.

To complete this all-silicone insulating system, assembled cores and coils are impregnated with Dow Corning 997 Varnish; lead wires are covered with Silastic,\* the Dow Corning silicone rubber. No. 60

\*T.M. REG. U.S. PAT. OFF.



## SILICONE RUBBER ASSURES RELIABILITY OF ELECTRONIC "PACKAGES" ON B-58

In reaching for new plateaus of performance and reliability, designers are getting an assist from Silastic®, the Dow Corning silicone rubber. Typical is the extensive use of Silastic to insulate and protect the delicate electronic "packages" in the fire control system on Convair's B-58 Hustler.

In developing the "packages," heat was a major problem encountered by the designers—the Electronics and Avionics

Division of Emerson Electric Manufacturing Company. Certain rubber parts touch miniature tubes that operate at 350 F. Other rubber components, such as seals, cable grommets and clamps, are totally enclosed in packages where even the "cooling" air gets hot. Extreme cold is another problem. When the fire control system is shut off during high altitude flight, temperatures may drop to 65 below zero.

But Silastic easily withstands both extremes of temperature and physical punishment. It stays rubbery from -130 to 500 F, has excellent dielectric strength, moisture resistance and long life. That's why Emerson specified Silastic, and that's why more and more engineers are specifying Silastic for maximum serviceability and minimum maintenance cost in applications ranging from aircraft seals to industrial heaters, from traction motors to home appliances.

\*T.M. REG. U.S. PAT. OFF.

No. 59

## Silicone Fluids on Insulators Stops Shorts and Grounds

Imaginative use of a silicone fluid has enabled Blue M Electric Company, Blue Island, Ill., to engineer faster response and more accurate heat control into its laboratory humidity cabinets.

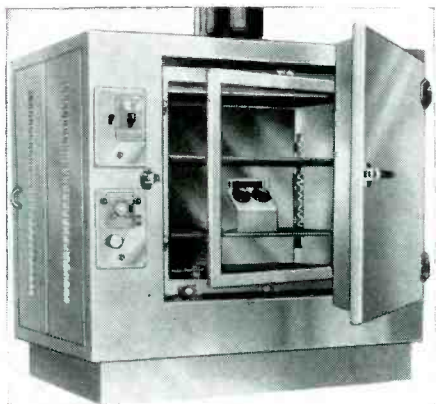

Moisture condensation on the steatite grommets that support the resistance wire

heating elements was always a problem in these cabinets. Moisture caused such a low resistance to ground that the elements had to be sheathed. This, of course, reduced the heat-up speed and made it more difficult to maintain accurate temperatures in the cabinets.

Blue M now controls the condensation problem by simply coating the ceramic insulators with Dow Corning 200 Fluid. The resulting water-repellent silicone surface is so successful in preventing the formation of conducting moisture films that the treated insulators withstand 1000 volts to ground even with droplets of water on their surface. As a result, Blue M has been able to change to faster, more accurate "open" elements without fear of grounds or shorts.

Blue M uses a 2% solution of Dow Corning 200 Fluid in carbon tetrachloride. The insulators are dipped into this solution and baked for one hour at 575 F. No. 61

**Send Coupon for More  
Information**

**DOW CORNING CORPORATION - Dept. 4824**  
Midland, Michigan

Please send me 59 60 61

NAME \_\_\_\_\_

TITLE \_\_\_\_\_

COMPANY \_\_\_\_\_

STREET \_\_\_\_\_

CITY \_\_\_\_\_ ZONE \_\_\_\_\_ STATE \_\_\_\_\_

ATLANTA • BOSTON • CHICAGO • CLEVELAND • DALLAS • DETROIT • LOS ANGELES • NEW YORK • WASHINGTON, D. C.

Canada: Dow Corning Silicones Ltd., Toronto; Great Britain: Midland Silicones Ltd., London; France: St. Gobain, Paris

←CIRCLE 51 READERS SERVICE CARD

CIRCLE 52 READERS SERVICE CARD

81

for  
+

**HIGH**

**INSULATION RESISTANCE  
and CAPACITANCE STABILITY**

**LOW**

**POWER FACTOR and SOAKAGE**



**f-c-i**

**Polystyrene Capacitors**

**are wound with**

**NATVAR  
Styroflex<sup>®</sup>**

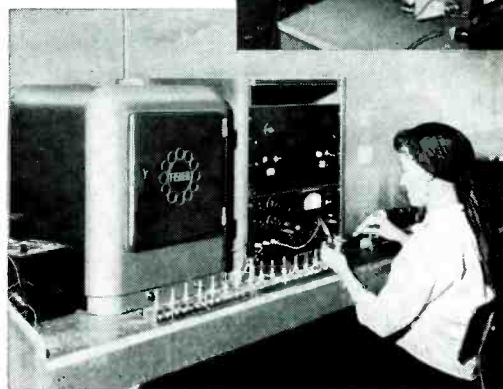

Film Capacitors, Inc., New York, manufactures capacitors for critical AC and DC circuitry applications—such as bridge arm elements, filter network components, standards of capacitance, RF tank circuits, storage circuits and computer circuits—where stability and high Q are essential.

Natvar Styroflex film is used as the dielectric in f-c-i polystyrene capacitors because of its uniformly high shock resistance and excellent dielectric properties. Because of its bi-axial orientation during the manufacturing process, it is completely flexible in all thicknesses, and easy to handle.

If you need an insulating material with the desirable characteristics of polystyrene—plus pliability, it will pay you to investigate Natvar Styroflex.

f-c-i polystyrene capacitors are available in hermetically sealed glass tubes, metal shells, bathtub cases, or metal cans. Operators like Styroflex because it winds easily, and testers find a minimum of rejects.



### Natvar Products

- Varnished cambric—cloth and tape
- Varnished canvas and duck
- Varnished silk and special rayon
- Varnished—Silicone coated Fiberglas
- Varnished papers—rope and kraft
- Slot cell combinations, Aboglas<sup>®</sup>
- Isoglas<sup>®</sup> sheet and tape
- Isolastane<sup>®</sup> sheet, tape, tubing and sleeving
- Vinyl coated—varnished tubing and sleeving
- Extruded vinyl tubing and tape
- Styroflex<sup>®</sup> flexible polystyrene tape
- Extruded identification markers

Ask for Catalog No. 24

**NATVAR CORPORATION**

FORMERLY THE NATIONAL VARNISHED PRODUCTS CORPORATION

TELEPHONE

FULTON 8-8800

CABLE ADDRESS

NATVAR: RAHWAY, N. J.

239 RANDOLPH AVENUE • WOODBRIDGE, NEW JERSEY



Microwave cooking shaves hours from food preparation time. This is a home-type electronic oven developed by Raytheon for production by appliance manufacturers.

# Meals in minutes by electronics— in permanent magnet equipped range

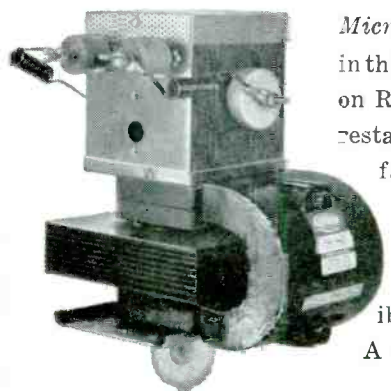

Microwave energy does the cooking in this domestic electronic oven based on Raytheon's "Radarange" for the restaurant industry. Microwaves are far higher in frequency than broadcast waves—fact, the magnetron tube (at left) steps up the vibrations to an incredible 2,450,000,000 times a second! A vital part of the magnetron is

the Crucible Alnico permanent magnet shown in the inset.

This is one of many practical applications for Crucible Alnico permanent magnets. Crucible has been a leading producer of permanent magnets, known for their *consistently higher* energy product, ever since Alnico alloys were developed. You can now order them sand cast, shell molded, or investment cast to every size, shape, or tolerance needed.

It's why an increasing number of manufacturers find the answer to their magnet problem at Crucible. *Crucible Steel Company of America, The Oliver Building, Mellon Square, Pittsburgh 22, Pa.*



first name in special purpose steels

**Crucible Steel Company of America**

CIRCLE 54 READERS SERVICE CARD

CIRCLE 55 READERS SERVICE CARD →

Permanent magnet is C-shaped casting at right of magnetron; box on top is filter assembly.

# HERE'S HOW TO SPECIFY

## Performance-Guaranteed TAPE WOUND CORES

Magnetics, Inc. manufactures "Performance-Guaranteed" Tape Wound Cores using such commercially available alloy materials as Hy Mu 80, 48 Alloy and Orthonol. These alloys, when properly processed, fill the majority of applications in which tape wound cores are used today.

Each "Performance-Guaranteed" Tape Wound Core is coded by a part number which describes it in great detail. Knowing this code will greatly simplify your purchasing and assembly line practices.

1. 50,000 series are Standard Cores in Phenolic Boxes  
51,000 series are Standard Cores in Aluminum Boxes
2. Number preceding final letter is tape thickness in mils
3. Final letter describes the high permeability material as follows: A—Orthonol D—Hy Mu 80 H-48 Alloy

*Example:* A typical core number is 51029-2A

1. 51,000 indicates a standard core in an Aluminum Core Box.
2. The number preceding final letter is 2, indicating tape thickness is 2 mils.
3. Final letter is A, showing Orthonol is the material.

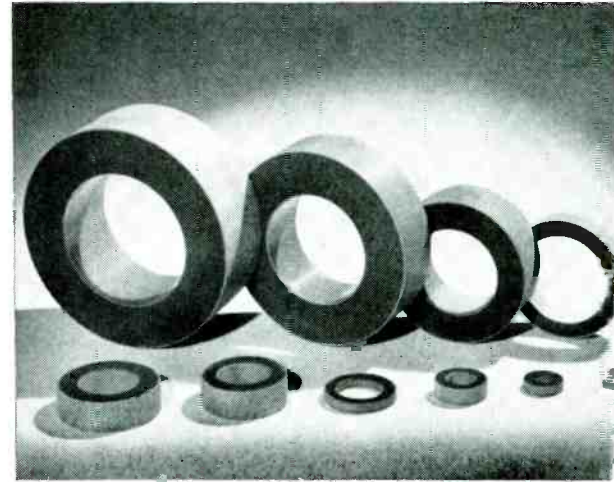
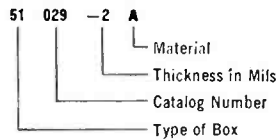

For complete information, write for Catalog-Design Manual TWC-200

**TABLE I • STANDARD SIZES OF TAPE WOUND CORES**

A <sub>2</sub> Aw X 10 <sup>-6</sup> (See Note 1)	CORE NUMBER (See Note 2)	CORE DIMENSIONS (In.)			NOMINAL CASE DIMENSIONS (In.)			CASE WIN- DOW AREA IN CIRCU- LAR MILS X 10 <sup>-6</sup>	MEAN LENGTH OF MAGNETIC PATH (Cm.)	EFFECTIVE CORE CROSS SECTION AREA (Cm. <sup>2</sup> )			I.D./O.D. RATIO
		I.D.	O.D.	Ht.	I.D.	O.D.	Ht. (See Note 3)			.001	.002	.004 & .006	
0.004	50153	0.375	0.500	0.125	0.315	0.560	0.195	0.099	3.49	0.041	0.043	0.046	0.750
*0.008	50056	0.500	0.625	0.125	0.440	0.685	0.195	0.194	4.47	0.040	0.043	0.045	0.800
0.013	50057	0.625	0.750	0.125	0.555	0.810	0.195	0.308	5.49	0.040	0.042	0.046	0.833
*0.017	50000	0.500	0.750	0.125	0.440	0.810	0.195	0.194	4.92	0.081	0.086	0.091	0.667
*0.030	50002	0.650	0.900	0.125	0.590	0.960	0.195	0.348	6.13	0.081	0.086	0.091	0.722
0.053	50033	0.625	0.875	0.250	0.555	0.945	0.330	0.308	5.99	0.162	0.172	0.182	0.714
0.059	50003	0.750	0.938	0.250	0.680	1.010	0.330	0.460	6.74	0.121	0.128	0.135	0.800
*0.059	50076	0.625	1.000	0.188	0.555	1.070	0.268	0.308	6.36	0.182	0.193	0.205	0.625
*0.074	50011	1.000	1.250	0.125	0.930	1.320	0.195	0.864	8.94	0.081	0.086	0.091	0.800
*0.079	50007	0.625	1.000	0.250	0.555	1.070	0.330	0.308	6.36	0.242	0.257	0.272	0.625
*0.079	50061	0.750	1.000	0.250	0.680	1.070	0.330	0.462	6.93	0.161	0.171	0.181	0.750
*0.089	50106	0.750	1.125	0.188	0.680	1.195	0.260	0.462	7.38	0.182	0.193	0.205	0.667
0.118	50168	0.750	1.000	0.375	0.680	1.070	0.455	0.462	6.97	0.227	0.257	0.272	0.750
0.119	50094	0.625	1.000	0.375	0.555	1.070	0.445	0.308	6.49	0.339	0.385	0.411	0.625
*0.148	50004	1.000	1.250	0.250	0.930	1.320	0.330	0.864	8.94	0.161	0.171	0.181	0.800
0.179	50034	0.750	1.125	0.375	0.680	1.195	0.455	0.460	7.49	0.342	0.389	0.405	0.667
0.186	50115	1.125	1.375	0.250	1.045	1.445	0.330	1.090	9.99	0.161	0.171	0.181	0.818
*0.222	50029	1.000	1.375	0.250	0.930	1.445	0.330	0.864	9.39	0.242	0.257	0.272	0.727
0.237	50188	0.750	1.250	0.375	0.680	1.320	0.455	0.462	7.98	0.453	0.514	0.544	0.600
0.250	50181	0.875	1.250	0.375	0.805	1.320	0.440	0.648	8.48	0.340	0.386	0.408	0.700
*0.296	50032	1.000	1.500	0.250	0.930	1.570	0.330	0.864	9.84	0.323	0.343	0.363	0.667
*0.444	50026	1.000	1.500	0.375	0.930	1.570	0.445	0.864	9.84	0.484	0.514	0.544	0.667
*0.469	50030	1.250	1.750	0.250	1.170	1.820	0.330	1.368	11.85	0.323	0.343	0.363	0.714
*0.592	50038	1.000	1.500	0.500	0.930	1.570	0.990	0.864	9.84	0.605	0.685	0.726	0.667
*0.597	50018	1.625	2.000	0.250	1.525	2.100	0.330	2.324	14.41	0.242	0.257	0.272	0.813
*0.937	50035	1.250	1.750	0.500	1.170	1.820	0.590	1.368	11.85	0.605	0.685	0.726	0.714
*1.055	50425	1.250	2.000	0.375	1.170	2.100	0.465	1.368	12.60	0.726	0.771	0.817	0.625
*2.471	50017	2.000	2.500	0.500	1.900	2.600	0.590	3.608	17.87	0.605	0.685	0.726	0.800
2.685	50040	1.500	2.000	1.000	1.400	2.100	1.110	1.960	13.99	1.211	1.370	1.457	0.750
*2.686	50001	1.500	2.500	0.500	1.400	2.600	0.590	1.959	15.79	1.210	1.371	1.452	0.600
*3.944	50031	2.500	3.000	0.500	2.400	3.100	0.590	5.757	21.73	0.605	0.685	0.726	0.833
*4.947	50103	2.000	3.000	0.500	1.900	3.100	0.590	3.608	19.67	1.210	1.371	1.452	0.667
*7.320	50128	2.500	3.500	0.500	2.312	3.688	0.713	5.343	23.71	1.210	1.371	1.452	0.714
*9.893	50022	2.000	3.000	1.000	1.900	3.100	1.110	3.608	19.67	2.419	2.742	2.903	0.667
*14.661	50042	2.500	3.500	1.000	2.313	3.688	1.188	5.343	23.71	2.419	2.742	2.903	0.714
*22.907	50080	2.500	3.750	1.250	2.313	3.938	1.437	5.347	24.59	3.780	4.284	4.536	0.667
*27.489	50100	2.500	3.750	1.500	2.313	3.938	1.688	5.347	24.59	4.536	5.141	5.444	0.667
*48.176	50081	3.250	4.500	1.500	3.062	4.688	1.688	9.371	30.64	4.536	5.141	5.444	0.722
*67.452	50427	3.250	5.000	1.500	3.062	5.188	1.688	9.371	32.40	6.351	7.198	7.621	0.650
*99.617	50112	4.000	5.250	2.000	3.782	5.469	2.280	14.063	36.66	6.048	6.855	7.258	0.762
*159.386	50426	4.000	6.000	2.000	3.782	6.280	2.276	14.532	39.34	9.677	10.968	11.613	0.667

\*A.I.E.E. Proposed Standard Size.

Note 1—Product of window area and iron area calculated for 2 mil material.

Note 2—Part numbers listed are for phenolic cases. Specify 51000 series for aluminum cases (last three numbers remain the same).

Note 3—Dimensions listed are nominal sizes for phenolic cases. For aluminum cases, add .015 to .020 inches to heights shown.

**TABLE II • NAMES OF SIMILAR MATERIALS**

D—Hy Mu 80	H-48 Alloy	A—Orthonol
4-79 Permalloy MO—Permalloy Mu Metal*	Carpenter 49 Allegheny 4750 Hipernik	Orthonik Deltamax Hipernik V

\*This material has a different composition than the others in the same column. The characteristics of this material are such that in general it is not recommended for use in tape wound cores.

### MATCHED CORES

Magnetics, Inc. will match cores within 5% over the entire voltage-current loop. Matching prior to winding results in improved yield and economical production. There is a very slight service charge for matching cores.

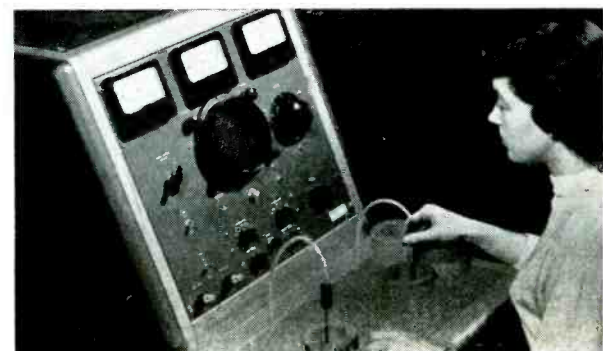



# MAGNETICS INC. PRODUCTS

## Performance-Guaranteed BOBBIN CORES

TABLE III • STANDARD CERAMIC AND STAINLESS BOBBIN CORES

PART NO.	NOMINAL DIMENSIONS IN INCHES							
	A	B	C	D	E	F	G	
CERAMIC BOBBIN	80002-B	.125	.140	.185	.090	.030	.200	.030
	80003-B	.188	.140	.248	.148	.030	.200	.030
	80023-A	.250	.140	.310	.210	.030	.200	.030
	80004-B	.313	.140	.373	.270	.030	.200	.030
	80018-A	.313	.140	.435	.270	.030	.200	.061
	80009-B	.375	.140	.435	.330	.030	.200	.030
	80017-A	.563	.140	.685	.513	.030	.200	.061
STAINLESS STEEL BOBBIN	80163	.110	.050	.140	.100	.005	.060	.015
	80164	.110	.140	.140	.100	.005	.150	.015
	80165	.125	.075	.185	.105	.010	.095	.030
	80166	.125	.140	.155	.110	.005	.150	.015
	80167	.188	.140	.248	.168	.010	.160	.030
	60168	.313	.140	.373	.293	.010	.160	.030

For Additional Information, Write for Bulletin BC-102

Bobbin cores are now being made in combinations of the following dimensions. Other sizes can be supplied on request.

\*BOBBIN DIAMETERS:  $\frac{1}{8}$ ",  $\frac{3}{16}$ ",  $\frac{1}{4}$ ",  $\frac{5}{16}$ ",  $\frac{3}{8}$ ",  $\frac{7}{16}$ ",  $\frac{1}{2}$ ",  $\frac{5}{8}$ ",  $\frac{3}{4}$ ",  $1$ ",  $1\frac{1}{4}$ ",  $1\frac{1}{2}$ ".

†TAPE WIDTH:  $\frac{1}{16}$ ",  $\frac{1}{8}$ ",  $\frac{1}{4}$ ",  $\frac{3}{8}$ ",  $\frac{1}{2}$ ",  $1$ ",  $1\frac{1}{2}$ ".

TAPE THICKNESS: 0.000125", 0.000250", 0.0005", 0.001".

BUILD-UP: 1 wrap to several hundred.

MATERIALS: 4-79 Mo Permalloy, Orthonol.

\* $1\frac{1}{2}$ -in. diam. bobbin is not standard, but can be furnished upon request.

†Not with standard bobbins if tape width is over  $\frac{1}{4}$ -in., but can be furnished upon request.

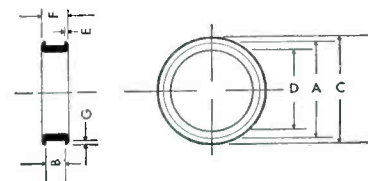

## Performance-Guaranteed POWDER CORES

TABLE IV • MOLYBDENUM PERMALLOY POWDER CORES

Core Number	$\mu$	Inductance (mh) 1000 Turn Coil			Dimensions (inches) before finish									
		Min.	Nom.	Max.	O.D.			I.D.			Height			Radii
					Min.	Nom.	Max.	Min.	Nom.	Max.	Min.	Nom.	Max.	
55206-A2	125	58	68	83	.790	.800	.810	.495	.500	.505	.240	.250	.260	.032
55848-A2	60	28	32	39	.790	.800	.810	.495	.500	.505	.240	.250	.260	.032
55511-A2	26	12	14	17	.790	.800	.810	.495	.500	.505	.240	.250	.260	.032
55057-A2	14	6.6	7.8	9.2	.790	.800	.800	.495	.500	.505	.240	.250	.260	.032
55310-A2	125	77	90	104	.890	.900	.910	.547	.550	.553	.290	.300	.310	.062
55930-A2	125	136	157	179	1.050	1.060	1.070	.575	.580	.585	.428	.440	.452	.075
55894-A2	60	65	75	86	1.050	1.060	1.070	.575	.580	.585	.428	.440	.452	.075
55395-A5	60	65	75	86	1.050	1.060	1.070	.575	.580	.585	.428	.440	.452	.075
55066-A2	26	28	32	37	1.050	1.060	1.070	.575	.580	.585	.428	.440	.452	.075
55068-A2	14	15	18	20	1.050	1.060	1.070	.575	.580	.585	.428	.440	.452	.075
55548-A2	125	106	127	148	1.288	1.300	1.312	.780	.785	.795	.400	.420	.437	.062
55585-A2	125	71	79	91	1.335	1.350	1.365	.908	.920	.925	.333	.350	.367	.062
55324-A2	125	101	117	137	1.395	1.410	1.425	.868	.880	.885	.400	.412	.424	.062
55254-A2	125	146	168	195	1.558	1.570	1.582	.938	.950	.955	.555	.570	.585	.100
55438-A2	125	248	281	325	1.825	1.840	1.855	.938	.950	.955	.690	.710	.730	.100

For Complete Details, Write for Bulletin PC-103

## Performance-Guaranteed MAGNETIC LAMINATIONS

TABLE V • STANDARD MAGNETIC CORE LAMINATION SHAPES

LAMINATION TYPE	STACK HEIGHT (inches)	WINDOW AREA (sq. in.) W	CROSS-SECTION AREA (sq. in.) A	W x A	LAMINATION TYPE	STACK HEIGHT (inches)	WINDOW AREA (sq. in.) W	CROSS-SECTION AREA (sq. in.) A	W x A
DU 1	$\frac{1}{4}$	.5625	.063	.035	EI 375	$\frac{3}{8}$	.234	.141	.033
DU 37	$\frac{3}{8}$	1.125	.141	.159	EI 625	$\frac{3}{8}$	.293	.391	.115
DU 50	$\frac{1}{2}$	2.000	.250	.500	F 12	.344	.188	.118	.022
EE 24-25	$\frac{1}{4}$	.125	.063	.008	F 12	(Modified)	.344	.188	.118
EE 26-27	$\frac{3}{8}$	.172	.141	.024	F 13	.344	.190	.118	.022
EE 28-29	$\frac{1}{2}$	.039	.014	.0005	F 20	$\frac{3}{8}$	.371	.141	.052
EE 186-187	$\frac{3}{16}$	.125	.063	.008	F 21	$\frac{1}{2}$	.257	.25	.064
EI 11	$\frac{3}{8}$	.574	.766	.440	Ring	Variable	Variable	Variable	Variable
EI 12	1	.750	1.000	.750	U-BE	$\frac{1}{4}$	.313	.063	.020
EI 21	$\frac{1}{2}$	.254	.250	.064	UI 312	$\frac{5}{16}$	.293	.098	.028
EI 75	$\frac{3}{4}$	.422	.563	.237	UI 375	$\frac{3}{8}$	.422	.141	.059
EI 187	$\frac{3}{16}$	.082	.035	.003					

Performance-Guaranteed laminations are made from any commercially available soft magnetic material. Heat treatment for specific properties may be specified but should be checked by Magnetics, Inc. Engineering Department if the Performance-Guarantee is to apply. When asking for quotations, describe, if possible:

1. Shape required
2. Grade of magnetic steel
3. Gauge of lamination
4. Surface insulation

For Complete Details, Write for Catalog ML-201.

## Performance-Guaranteed MAGNETIC SHIELDS

TABLE VI • MAGNETIC SHIELDS

Tube To Be Used With	Tube Mfr.	Magnetics, Inc. Part No.	Tube To Be Used With	Tube Mfr.	Magnetics, Inc. Part No.	Tube To Be Used With	Tube Mfr.	Magnetics, Inc. Part No.
RS-1, 2, 3		40012	5 AMP-1	Dumont	40036	7 MP	Dumont	40120
RS-4, 5, 6		40013	5 BP-1	RCA	40086	7 JP-1, 4	RCA	40005
RS-7, 8, 9		40014	5 BPA	Dumont	40086	7 VP-1	RCA	40005
2 BP-1, 11	RCA	40024	5 CP-1A	RCA	40087	10 SP-4	RCA	40031
3 ACP	Dumont	40023	5 CPA	Dumont	40087	10 WP-7	Dumont	40031
3 BP-1A	RCA	40023	5 FP-4, 7	RCA	40149	5819	RCA	40050
3 JP-1, 7	RCA	40023	5 AHP & 5FP	Dumont	40149	K 1197	Dumont	40021
3 GPA	Dumont	40007	3 JPA	Dumont	40044	6363	Dumont	40021
3 KP-1, 4, 11	RCA	40007	5 LPA	Dumont	40151	K-1198	Dumont	40022
3 MPI	RCA	40148	5 RP	Dumont	40119	6364	Dumont	40022
3 RPA	Dumont	40001	5 UP-1, 7, 11	RCA	40000	K-1211	Dumont	40067
3 RP-1	RCA	40001	5 WP-11, 15	RCA	40150	6199	RCA	40015
3 WPI	Dumont	40074	5 XP	Dumont	40153	6292	Dumont	40020
5 ABP-1, 7, 11	RCA	40019	5 YP	Dumont	40152	6467	Dumont	40055
5 ADP	Dumont	40019	7 ABP	Dumont	40120	931-A	RCA	40066
5 AFP	Dumont	40109	7 MP-7, 14	RCA	40120			

For Further Details, Write Sales Engineering Dept.

DEPT. E-39



BUTLER, PENNSYLVANIA



## What happens to soldered joints at "fifty below"?

"Dutch Boy" solder specialists tell how to make sure they hold when cold

Push temperature down and lead's strength goes up — without major loss in ductility.

Not so with tin. Below  $-18^{\circ}\text{F}$ , tin may suffer allotropic transformation. Gets brittle. Changes color.

Recent "Dutch Boy" research shows, as you might expect, that lead-tin solders tend to split this difference in rough proportion.

A 50-50 solder, for example, yields joints with higher tensiles at  $-75^{\circ}\text{F}$  than at room temperature. But it's more brittle. At  $-75^{\circ}\text{F}$  the joined metals still fail before the joint. Further down the temperature scale, joints fail first.

Increasing the lead content lowers the temperature at which joints retain good ductility. But strength does not increase as rapidly as temperatures go down.

Up to 15%, tin content has little effect on ductility. Beyond that, the loss in ductility (and in impact and fatigue resistance) that occurs as temperatures go below  $-18^{\circ}\text{F}$  should be considered.

### Allotropic change in tin may be inhibited with antimony

For makers of aircraft, missile and arctic electronic equipment, and for others whose products meet with extreme low temperatures, a recent proposed change

in Government specs is of interest.

This proposal, which calls for 0.2 to 0.5% antimony in solders in the 40 to 70% tin range, is based on investigations showing that antimony inhibits allotropic change in tin as the thermometer falls.

Your "Dutch Boy" Solder specialist is well informed on this and other frontier areas of solder technology now under investigation at National Lead Laboratories and elsewhere. Use his specialized knowledge freely. Or write National Lead Company, 111 Broadway, New York 6, N. Y.

**Dutch Boy**   
SOLDER AND FLUXES

# Sperry's combination radar test sets integrate all testing functions

Faster, simpler radar maintenance is the pay-off with the Sperry Combination Test Sets. One set does the job of three or more standard test units but requires one-quarter the space and weighs half as much! Here are the five functions each Sperry test set performs:

**POWER METER:** Directly measures average power of radar transmitter with accuracy of  $\pm 1.0$  db.

**FREQUENCY METER:** Indicates directly the frequency of both receiver and transmitter.

**SPECTRUM ANALYZER:** Accurately displays power vs. frequency spectrum of transmitter signals from single or multi-pulse systems. Display is stable at all pulse widths and repetition rates.

**SYNCHROSCOPE:** Simple general-purpose synchroscope functions as an "A" scope and displays radar video signals or similar wave forms—no need for auxiliary synchroscope.

**SIGNAL GENERATOR:** Accurately and directly calibrated output signal level is variable over complete range. Choice of pulse, frequency or external modulation.

With no additional equipment you can also measure transmitter peak power, repetition rate, transmitter pulse width, T.R. recovery time, duplexer losses, transmission line VSWR. Designed for tough operating conditions, these sets comply fully with military specification MIL-T-945A. Your nearest Sperry district office will gladly supply you with complete operating data.



Microline Model 570  
16" L x 15" W x 15" H

## COMPLETE LINE OF TEST SETS

Band	Microline* Model	Military Type	Frequency
L	670		400-450mc
S	590B	UPM-44B	2700-3500mc
C	551A	SPM-5	5100-5900mc
X	570	UPM-32	8500-10500mc
K	557		23500-24500mc
V	580A	UPM-14	34000-35600mc

\*T. H. REG. U. S. PAT. OFF.

MICROWAVE ELECTRONICS DIVISION

**SPERRY** *GYROSCOPE COMPANY*  
Great Neck, New York

DIVISION OF SPERRY RAND CORPORATION

Brooklyn • Cleveland • New Orleans • Los Angeles  
San Francisco • Seattle. In Canada: Sperry Gyro-  
scope Company of Canada, Ltd., Montreal, Quebec.



# FREQUENCY STANDARDS DEVELOPMENT

**Hamilton**  
can meet your requirements for

# STANDARDS DEVELOPMENT

Hamilton Watch Company's Instrument Division now offers you complete facilities for developing, designing and fabricating of frequency standards to your specifications. Complete circuitry development and packaging of miniature transistorized tuning fork frequency standards is provided.

The accuracy and stability required for precision timing systems is available to you through the experience of our research and development engineers, combined with complete production facilities.

***We are ready to review your requirements.***

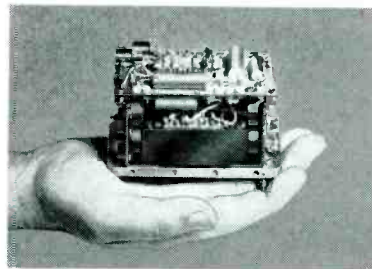

**PHONE OR  
WRITE**

*giving us your  
specifications for  
prompt analysis.*



**HAMILTON WATCH COMPANY**  
5800 EAST JEWELL AVENUE • DENVER 22, COLORADO  
**HATHAWAY INSTRUMENT DIVISION**

# UNION



## NEW SERVO-RATIO MULTIMETER

Combines all the functions of an AC-DC voltmeter, ohmmeter and AC-DC ratiometer in one compact portable unit

Here is a new, highly accurate test instrument designed to make life easier for those who work with computers and other electronic and electrical devices. It measures AC-DC ratios, absolute AC-DC voltages and resistance. You can also measure the gain of operational amplifiers using the 0° phase output provided.

The Servo-Ratio Multimeter computes voltage ratios by dividing the voltage to be measured by the reference voltage obtained from the computer. It is a high-impedance instrument and utilizes a motor-driven, position-type servo mechanism. Average time to obtain a reading is three seconds. Simplification and reliability are obtained through the use of printed circuits.

The front panel contains a four-digit illuminated drum counter for readout, phase or polarity indicating lights, function switch, ON-OFF

switch, range switch, 0° phase ratio selector, input terminals and 0° phase output terminals.

The Servo-Ratio Multimeter is compact and easy to handle. It has an aluminum case and weighs only 10 pounds. The instrument can be operated in a horizontal or vertical position and has a unique carrying handle that serves as a tilt-stand when the unit is used horizontally. Write for Product Description 2005.

### SPECIFICATIONS

Power Consumption: 50 Watts, 110 Volts, 60 cps.  
Reference Voltage: DC or 60 cps AC;  $\pm 10$  Volts to  $\pm 100$  Volts across 8.7K Ohms Load.

Functions	Range
Ratio, AC	0.001 to 1.000 $\pm 0.1\%$ in 1 range
Ratio, DC	0.001 to 1.000 $\pm 0.1\%$ in 1 range
60 cps AC Voltage	1 Volt to 1000 Volts full scale $\pm 1.0\%$ in 4 ranges
DC Voltage	1 Volt to 1000 Volts full scale $\pm 1.0\%$ in 4 ranges
Ohms	10K Ohms to 10 Megohms full scale $\pm 1.0\%$ in 4 ranges
Gain	0.01 to 1000 in 4 ranges

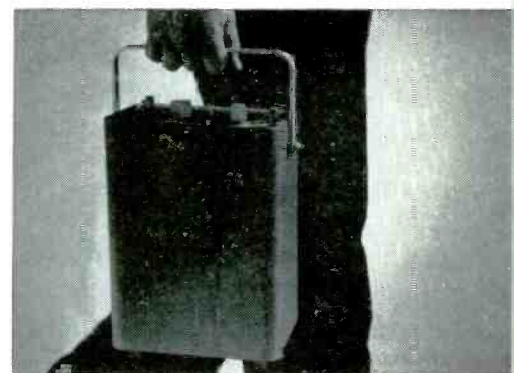

PORTABLE AND COMPACT—Weighs only 10 pounds. Size: 7 $\frac{7}{8}$ " x 5 $\frac{1}{2}$ " x 11-13/16".

SIMPLIFIES TESTING—Eliminates need for many other instruments. Has digital readout counter.



## UNION SWITCH & SIGNAL

DIVISION OF WESTINGHOUSE AIR BRAKE COMPANY

PITTSBURGH 18, PENNSYLVANIA

CIRCLE 59 READERS SERVICE CARD



## Ucinite Magnetron Connectors

Ucinite manufactures a variety of special connectors for the heater and heater-cathode terminals of magnetrons. Many of these have been adapted for special applications as to size and function to meet the sealing and mounting requirements of high temperature and high altitude operation and other special conditions.

Connectors are coaxial in construction and can be supplied with built-in capaci-

tors for added protection. Connecting leads of any length can be furnished to customer's specifications.

With an experienced staff of design engineers, plus complete facilities for volume production, Ucinite is capable of supplying practically any need for metal or metal-and-plastics assemblies. Call your nearest Ucinite or United-Carr representative for full information or write directly to us.



**The**  
**UCINITE CO.**  
*Newtonville 60, Mass.*  
Division of United-Carr Fastener Corp.

*Specialists in*  
**ELECTRICAL ASSEMBLIES,**  
**RADIO AND AUTOMOTIVE**

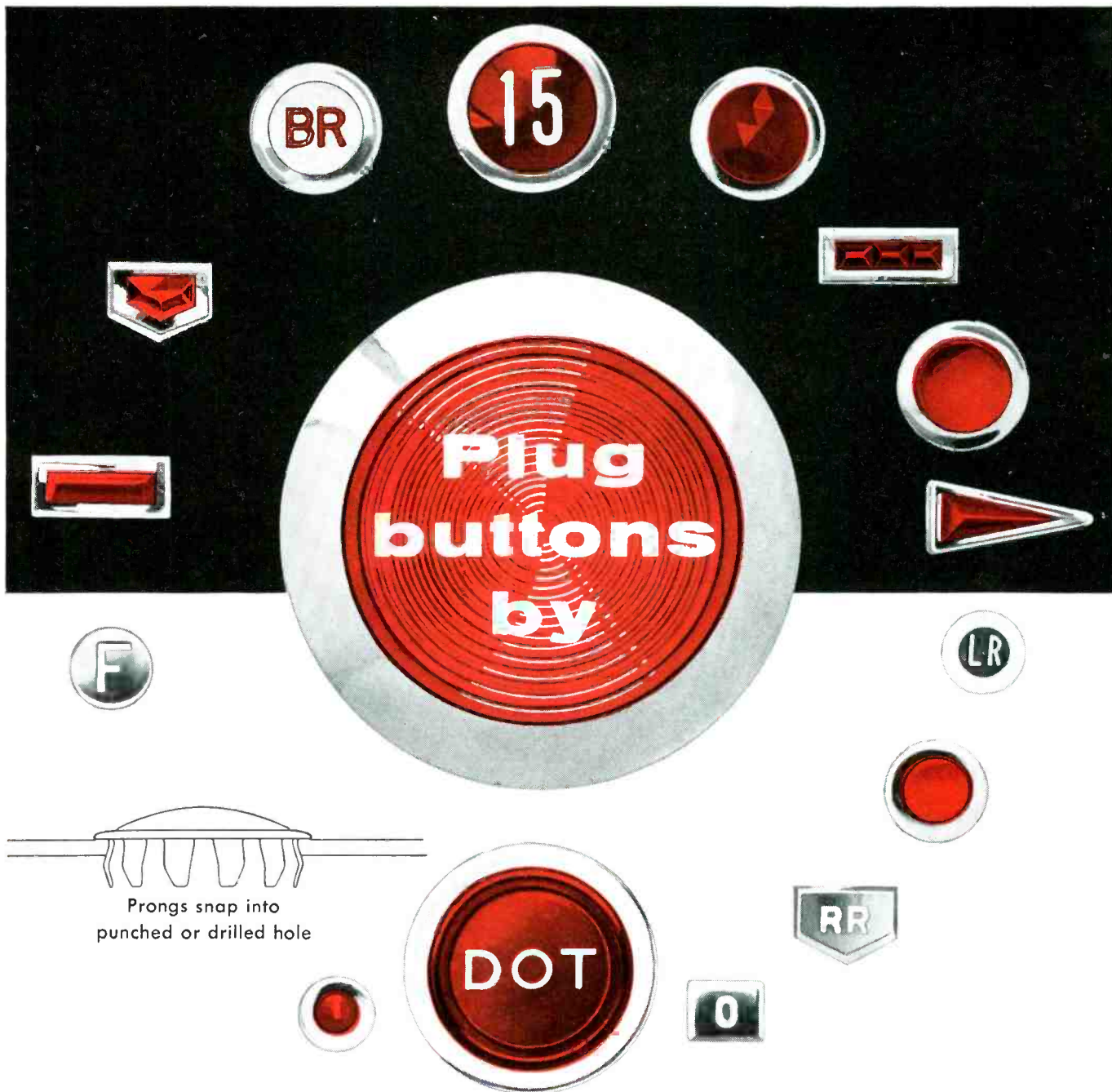

**CUSTOM-DESIGNED AND MASS PRODUCED  
TO YOUR PARTICULAR REQUIREMENTS**

Dot plug buttons were originally used in automobiles to fill spaces on standard models which, on de luxe models would be occupied by such extras as cigarette lighters, radio controls and so on. They are now also widely used as lenses for indicator lights and as identification buttons on instrument and control panels of all kinds.

Available in clear or colored plastics... brass or steel in all standard finishes... embossed and enamel-filled or molded to show company insignia or other identification symbols... Dot plug buttons snap into place and stay where they're put even under conditions of extreme vibration. Yet they can be removed and replaced repeatedly without damage.

**CARR FASTENER COMPANY**

DIVISION OF UNITED-CARR FASTENER CORPORATION 31 Ames Street, Cambridge 42, Massachusetts



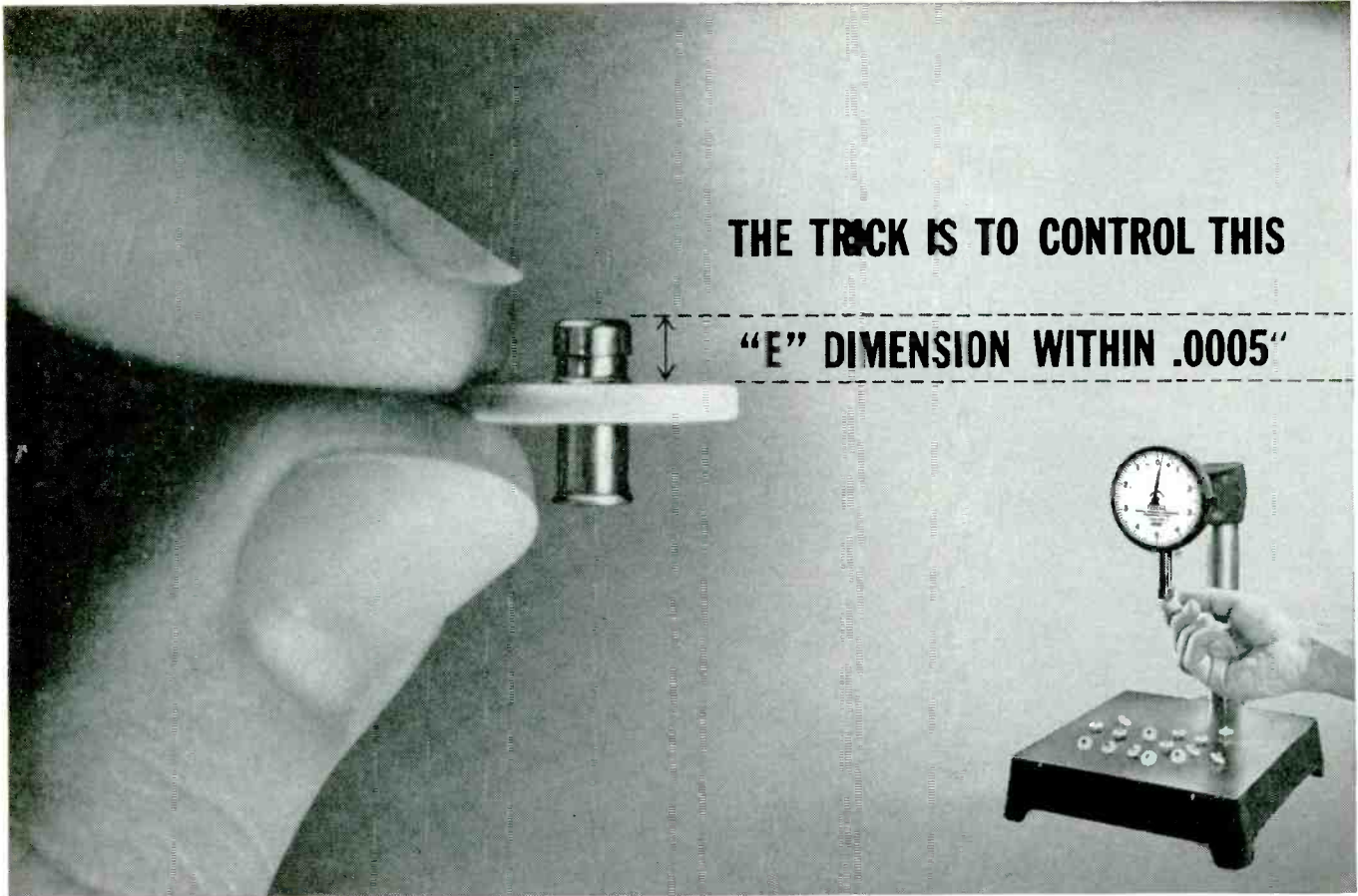

**THE TRICK IS TO CONTROL THIS**

**"E" DIMENSION WITHIN .0005"**

Dial indicator gage measures the critical "E" dimension.

## Precision disc cathodes simplify assembly of TV picture tubes

Because Superior Tube guarantees such close tolerance in disc cathode "E" dimension, makers of TV picture tubes can save the time and cost of compensating for variations.

Cathodes can be used universally in different tubes, and are interchangeable with each other during electron gun assembly. This means both manufacturing efficiency and quality control can be significantly improved.

In addition, Superior Tube precision disc cathodes offer these four important advantages:

1. **Separate cap alloy.** Permits use of best alloys for both cap and shank in varying applications.
2. **Slight flare of shank opening.** Easier insertion of heater. Less abrasion of heater coating during normal expansion and contraction.
3. **Shadow groove in ceramic.** Inhibits electrical leakage between cathode and No. 1 grid.
4. **Chemically clean shank interior.** Minimizes heater-cathode leakage.

Superior Tube disc cathodes are available in three sizes: standard, narrow neck making possible shorter tubes, and miniature for 3-gun color TV picture tubes. Write for complete information to Superior Tube Co., 2500 Germantown Ave., Norristown, Pa.

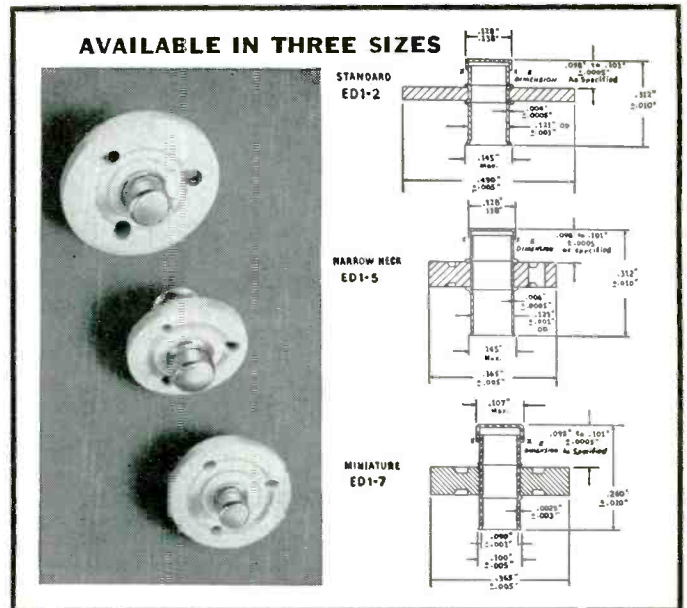

**HOW SUPERIOR DOES IT**—GENERAL CERAMICS CORPORATION, Keasbey, N.J., working for many years with Superior Tube's engineers, has developed mass-production methods resulting in the supply of millions of close-tolerance insulators which have greatly assisted in achieving this uniform "E" dimension. These insulators are produced under rigid quality controls. The cathode shank is double-beaded to the ceramic to insure tight fit. The cap is electrically spot-welded to the shank while held in a precision jig.

*Superior Tube*  
The big name in small tubing  
NORRISTOWN, PA.

Johnson & Hoffman Mfg. Corp., Mineola, N.Y.—an affiliated company making precision metal stampings and deep-drawn parts such as those used in the electron guns that go with this new cathode.



having your ups and downs?



... if they involve WIRE WOUND RESISTORS ←

# DALOHM has the answer

You can depend on



All Dalohm products are carefully designed and skillfully made to assure you of supreme quality and dependability, plus the widest versatility of application. Here are outstanding examples of the Dalohm line:

## WIRE WOUND ENCAPSULATED PRECISION RESISTORS

Surpass MIL-R-93R

Completely impervious to penetrating effects of salt ions, humidity, moisture and corrosive gases and vapors, Dalohm's new encapsulating material has very high di-electric strength. Its coefficient of expansion matches that of the resistor wire itself, eliminating the possibility of distorted wiring and shorted turns. All are non-inductive, pi-wound.

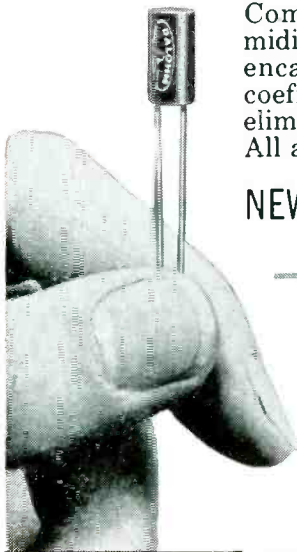

### NEW SUB-MINIATURE SIZES

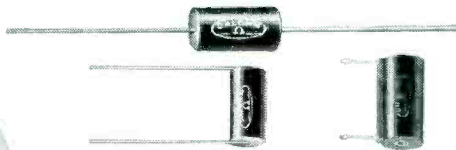

- Resistance range 10 ohm to 1 megohm
- Tolerances 0.05%, 0.1%, 0.25%, 0.5%, 1%, 3%
- Powered at 0.1 watt to 0.8 watt
- Temperature coefficient 0.00002/Deg. C
- Maximum operating temperature 125° C.

#### SIZES

	Length	Dia.	TERMINALS
WWA 13	3/8"	1/8"	WWL—lugs;
WWA and WWP 22	1/4"	1/4"	WWA—axial leads;
WWL and WWR 23	3/8"	1/4"	WWR—radial leads;
WWA, WWL, WWR, WWP 24	1/2"	1/4"	WWP—parallel leads.
WWA 26	3/4"	1/4"	
WWA, WWL, WWR, WWP 34	1/2"	3/8"	
WWA, WWL, WWR, WWP 36	3/4"	3/8"	
WWA, WWL, WWR, WWP 38	1"	3/8"	

### STANDARD SIZES

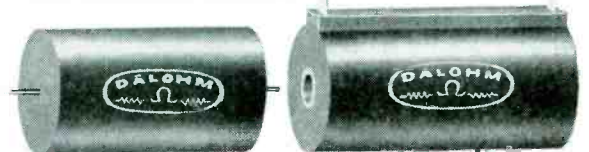

WWA

WWL

- Resistance range 0.1 ohm to 5 megohms
- Tolerances 0.05%, 0.1%, 0.25%, 0.5%, 1%, 3%
- Powered at 0.5 watt to 2 watts
- Temperature coefficient 0.00002/Deg. C
- Maximum operating temperature 125° C.

#### SIZES

	Length	Dia.
WWA and WWL 44	1/2"	1/2"
WWA and WWL 45	5/8"	1/2"
WWA and WWL 48	1"	1/2"
WWA and WWL 4-12	1 1/2"	1/2"
WWA and WWL 4-16	2"	1/2"

#### TERMINALS

WWA—axial leads; WWL—lugs.

Also available in MIL Types RB-09, RB-15, RB-16, RB-17, RB-18, RB-19

### JUST ASK US:

You are invited to write for the complete catalog of Dalohm precision resistors, potentiometers and collet-fitting knobs. If none of our standard line fills your need, our staff of able engineers and skilled craftsmen equipped with the most modern equipment, is ready to help solve your problem in the realm of development, engineering, design and production. Just outline your specific situation.

## DALE PRODUCTS, INC.

1300 28th Avenue  
Columbus, Nebr., U.S.A.  
EXPORT DEPT: Pan-Mar Corp.  
1270 Broadway  
New York 1, N.Y.

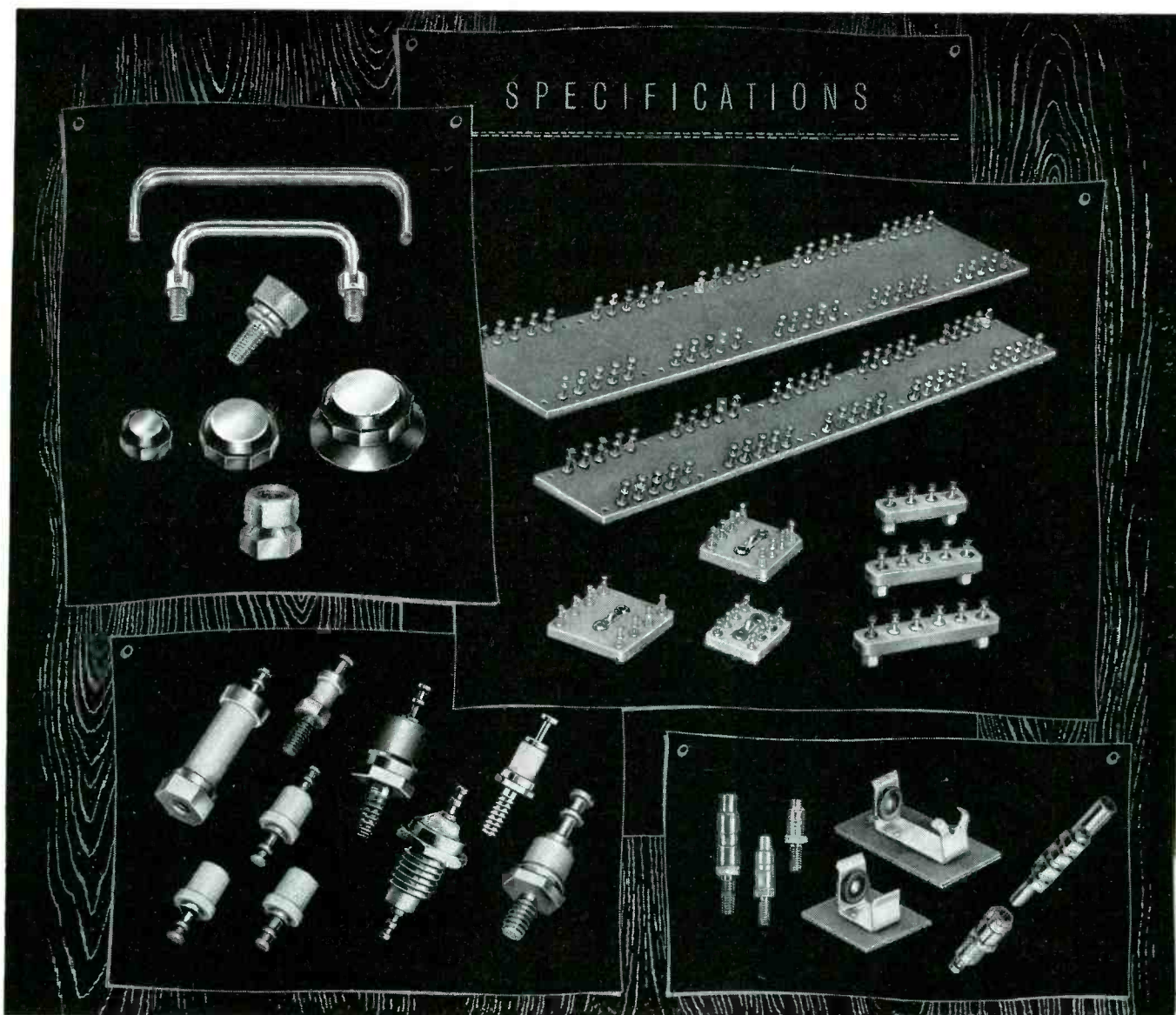

Photo shows wide variety of CTC components. Upper left, hardware, knobs, panel screws. Upper right, standard terminal boards, phenolic and ceramic. Bottom row, insulated terminals in ceramic and teflon, diode clips, battery clips, plugs and jacks. Common denominator — CTC reliability.

## If specifications call for durability specify CTC hardware

Durability is not just a term at CTC — it's practically a manufacturing process! Take the above line of CTC hardware for example. CTC guarantees it and every one of its components unconditionally — in any quantity! That's high quality control — quality control that meets or betters all applicable military and government specifications. CTC quality controls the raw material, each step of production and the finished product — the result — *exceptional durability*.

Best of all you get this durability economically. In fact — you couldn't make such hardware items

cheaper yourself! Our large selection of standard panel and chassis hardware fills most needs. If you require custom design, contact us direct.

Send for CTC's Catalog 600 — it has all the details of CTC's complete hardware line. Write to Sales Engi-

neering Dept., Cambridge Thermionic Corporation, 437 Concord Ave., Cambridge 38, Mass. On the West Coast contact E. V. Roberts and Associates, Inc., 5068 West Washington Blvd., Los Angeles 16, and 1560 Laurel St., San Carlos, Calif.

**CAMBRIDGE THERMIONIC CORPORATION**

*makers of guaranteed electronic components  
custom or standard*



# TECHNIQUES and DEVELOPMENTS in oscillographic recording

FROM  
**SANBORN**

## CIRCUIT DESIGN AND TYPICAL USES OF THE "150" CARRIER PREAMPLIFIER

One of the most frequently used plug-in front ends for Sanborn 150 Series oscillographic recording systems is the Model 150-1100 Carrier Preamplifier, since with it a "150" system can record such variables as force, temperature, strain, pressure, displacement, velocity, flow, acceleration — or any variable which can be expressed as a suitable input signal by a transducer. The "1100 Carrier" will operate with a variety of different transducers and bridge circuits, which will be mentioned later on.

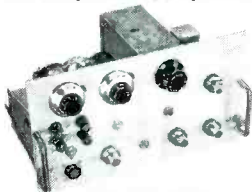

In the block diagram (Fig. 1).

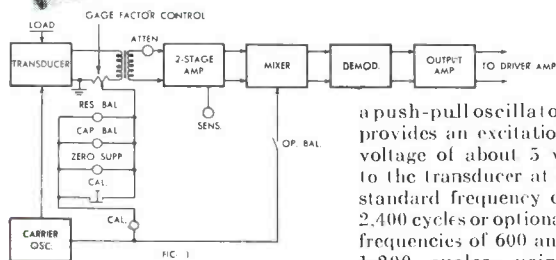

a push-pull oscillator provides an excitation voltage of about 5 v. to the transducer at a standard frequency of 2,400 cycles or optional frequencies of 600 and 1,200 cycles, using plug-in components.

This excitation voltage also feeds the Balancing, Calibration and Zero Suppression circuits. (The Balancing controls allow correction of resistive and reactive signal leakage from the

transducer, so that at zero load the net signal to the Pre-amplifier is zero. The Zero Suppression feature permits bucking out a large static load so that a small part of the load can be expanded over the full recording chart. The Gage Factor control allows the zero suppression range to be made equivalent to some convenient transducer load, or the full load rating of the transducer, and also causes the calibration signal to represent 2% of that load.) Transducer output is fed to the transformer through the Gage Factor potentiometer, across which the Balancing-Calibration-Zero Suppression circuits develop a voltage effectively in series with the transducer output. The mixer receives a suppressed carrier AM signal and re-inserts a carrier component, to make its output a conventional AM signal whose modulation represents the transducer load. The modulation signal (whose amplitude and polarity represent magnitude and direction of transducer output) is recovered by the demodulator and fed to the output amplifier, which in turn excites the Driver Amplifier and recording galvanometer of a "150" system.

Transducers which may be used with the Carrier Preamplifier include strain gage half-bridges or full-bridges, commercial resistance or reactance bridges, differential transformers and resistance thermometer bridges. The transducer chosen should provide at least 18.0 microvolts per volt of excitation at the minimum load to be recorded, for a one cm. deflection; impedance should be 100 to 1000 ohms. With strain gages, normal operation provides sensitivities of 50, 20 or 10 micro-inches per inch for each cm. on the recording, depending on the number of active gages. With resistance thermometers, if 1°C. or 2°F. per cm. stylus deflection is sufficient sensitivity, the user can construct his own resistance thermometer by including a 3 ohm coil of copper wire in one arm of an equal arm 100 ohm bridge.

*Helpful information about the use of transducers with the 150-1100 Preamplifier is contained in the following Sanborn RIGHT ANGLE articles (reprints on request): Coupling Differential Transformers, Aug. and Nov. 1956; Filter Networks for use with Force Dynamometers, Nov. 1956; Calibration with 1-, 2- or 4-arm Strain Gage Bridges, Aug. 1955; Theoretical and Actual Applications of Bridge Circuits, May and Aug. 1954.*

## Wing flutter recording to infrared research . . . with the versatile "1100 Carrier"

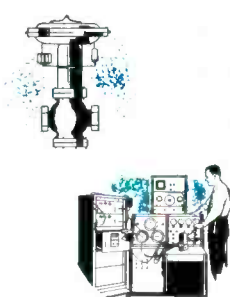

Today, Carrier Preamp-equipped Sanborn "150" systems are being used for frequency response tests of process control system components; to record shaft deflections of fluid mixing equipment; in infrared research . . . vehicular traffic studies . . . submarine hull vibration measurements. Applications are limited only by the transducers available.

These are applications of only one "150" front-end; eleven more interchangeable, plug-in Preamplifiers increase the scope of Sanborn oscillographic recording systems to meet an almost infinite variety of research, production and field testing requirements. All Sanborn "150" direct writing systems record inkless traces in true rectangular coordinates; all provide 1% linearity; Basic Assemblies — equipped with your choice of Preamps — are available from one- to eight-channels, packaged in vertical cabinets, portable cases, or specially modified housings.

Technical data and help with your oscillographic recording problem are always available from Sanborn.

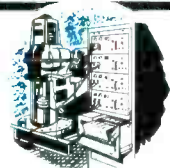

**SANBORN COMPANY**  
INDUSTRIAL DIVISION  
175 Wyman St., Waltham 54, Mass.

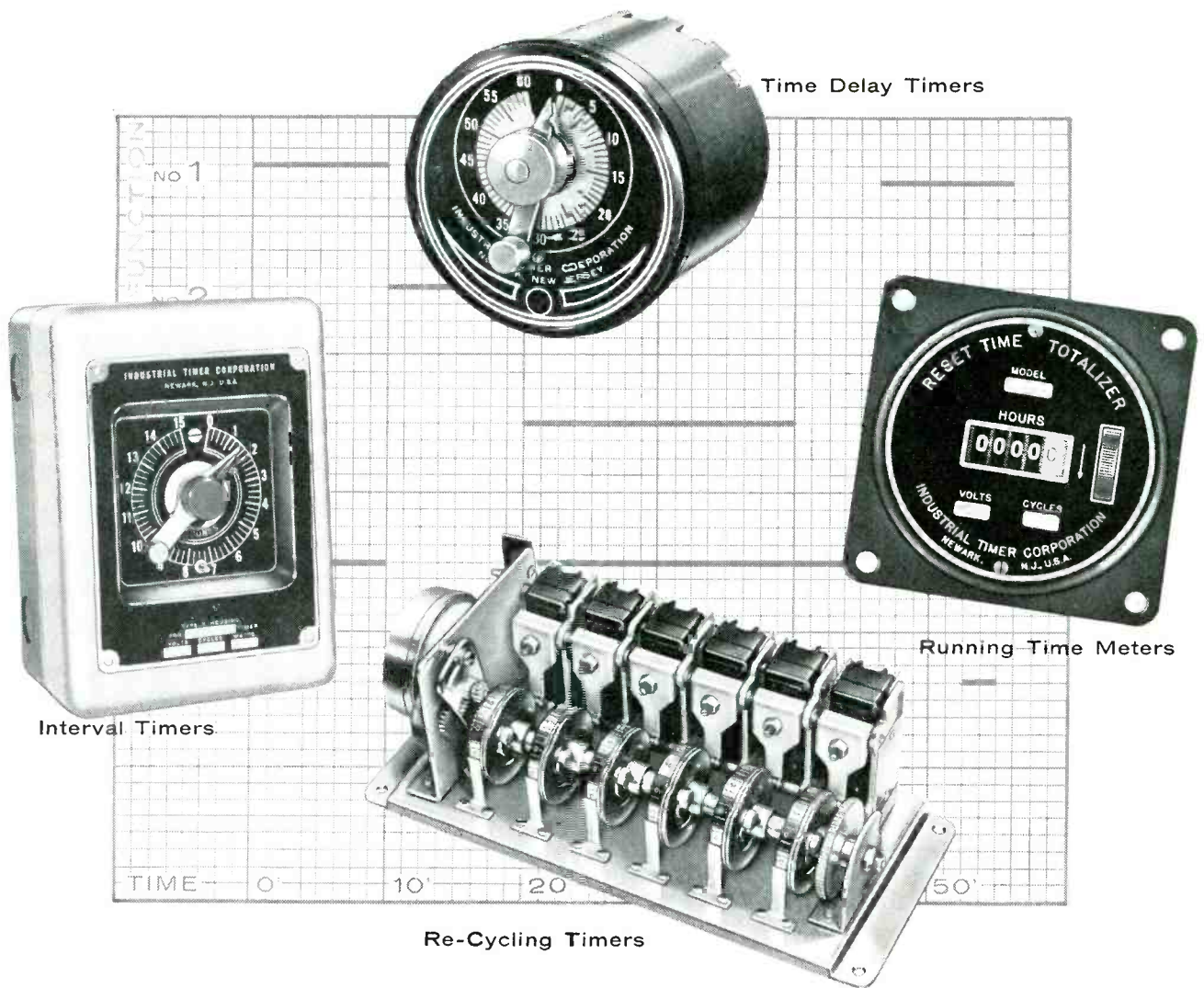

Time Delay Timers

Interval Timers

Running Time Meters

Re-Cycling Timers

## Timers for Automatic Control ...Standard or Special?

### You'll get quick deliveries from Industrial Timer

If slow deliveries of timers have been delaying you in your automatic control projects, try us! True, your problem may be different and difficult indeed, for no two automatic control jobs are exactly alike. But our record in helping out in situations like these is excellent. For in this field we have a valuable background, twenty years of timer experience to be exact, that has provided us with the special knowledge required to supply our customers with the right answers.

How do we do it? The answer is in what we believe to be

the largest variety of standard and combination timer units anywhere in the industry. To fill the widely varying needs of our customers, we manufacture a complete line of timers in the four broad classifications illustrated above: Time Delay Timers, Re-Cycling Timers, Interval Timers, and Running Time Meters. From these our timer engineers have developed 20 basic types which they have so far combined in over 1000 different ways. Therefore—many jobs that would seem to require a special timer, are in fact, a standard timer with us.

And our large stock assures you of rapid deliveries—even when we have to create a brand new timer for your special needs. So why not send us your specifications. You'll get a prompt reply and you may save yourself much lost motion.

*Timers that Control  
the Pulse Beat of Industry*



**INDUSTRIAL TIMER CORPORATION**

1409 McCARTER HIGHWAY, NEWARK 4, N. J.

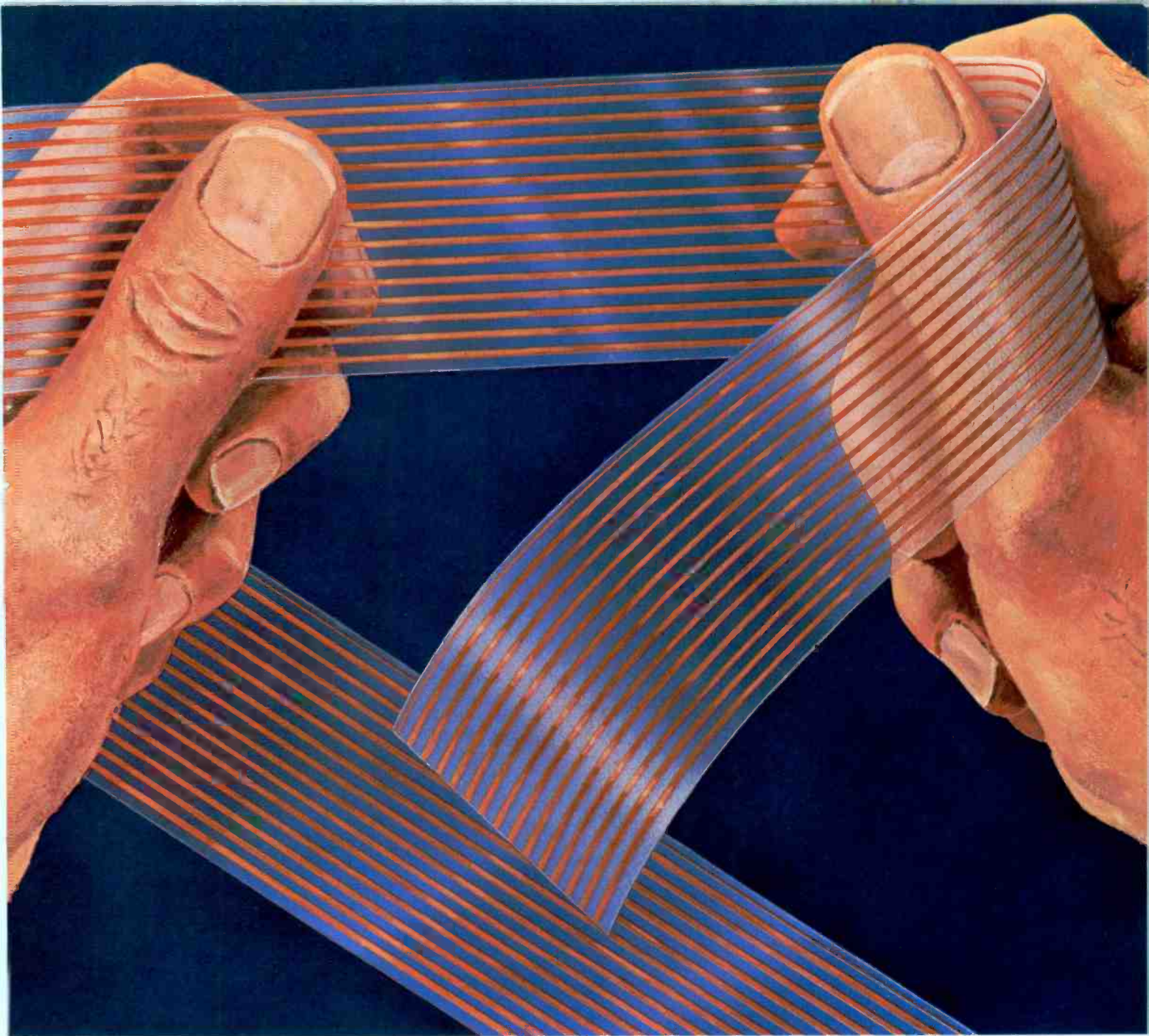

**THIN**

**LIGHT**

**FLEXIBLE**

**TOUGH**

## New...Tape Cable\*

### **A MAJOR ADVANCE IN INTER-WIRING**

Tape Cable's hair-thin copper conductors are imbedded in transparent polyester. Stripping, positioning and soldering of 40 conductor Tape Cable are accomplished in 30 seconds.

\*Tape Cable is a Trade-Mark of the Tape Cable Corp.—Pat. Pend.

Full technical data on reverse side

As seen in Electronics Magazine

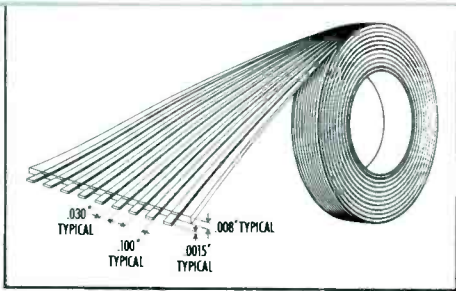

Dimensions of Standard Tape Cable



100 FEET OF TAPE CABLE 1M3-30  
1.78 lbs.  
100 FEET OF CONVENTIONAL 30 CONDUCTOR CABLE  
10.2 lbs.

Space & Weight Comparison of Tape Cable & Conventional Cable Having Same Number of Conductors & Current Rating

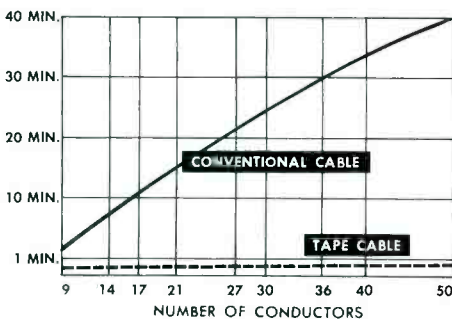

Tape Cable & Conventional Cable Compared in Terms of Labor Time Consumed in Stripping, Positioning & Soldering

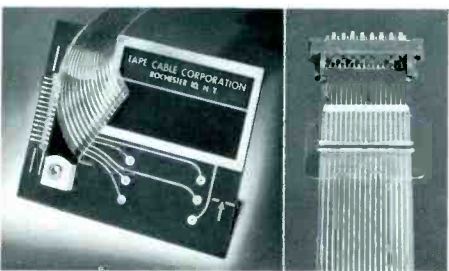

Tape Cable Terminations:  
To Printed Wiring Board & the Elco Plug

### PRICE LIST

25 FOOT ROLLS OF STANDARD TAPE CABLE

TYPE	NUMBER OF CONDUCTORS	PRICE
1M3-9	9 conductor	\$ 18.90
1M3-14	14 conductor	29.40
1M3-17	17 conductor	37.40
1M3-21	21 conductor	47.90
1M3-27	27 conductor	65.70
1M3-30	30 conductor	76.00
1M3-36	36 conductor	97.20
1M3-40	40 conductor	110.60
1M3-50	50 conductor	153.30

# Technical Data on Tape Cable\*

The flat copper conductors in standard Tape Cable have .100" center-to-center spacing in accordance with the recommended RETMA grid pattern for printed wiring. The standard conductor is .0015" by .030". This gives Tape Cable a high conductor density, 1160 conductors per cross-section square inch as compared with only 225 for ordinary cable having #22 wire insulated with .010" wall. The total thickness of standard Tape Cable is only .008". A 100 foot roll of 30 conductor Tape Cable weighs only 1.78 pounds. This is a saving of 80% in weight over conventional cable having round conductors of the same current handling capacity. Tape Cable requires less than 20% of the space of conventional cable. Where weight and space are critical, Tape Cable is especially applicable.

Tape Cable has a conservative rating of 1 amp. and 300 volts AC. It is ideal for high frequency applications because of its low and uniform interconductor capacitance of less than 5 mmf. per foot between conductors in free air.

Save 90% of labor costs by using Tape Cable because:

1. All conductors are stripped simultaneously.
2. Positioning one conductor automatically positions all conductors, and
3. All connections can be dip-soldered in one operation.

Stripping of all conductors simultaneously is rapid and easy with machines readily available. Scissors are used for hand stripping. Tape Cable may be stripped on both sides for soldering, or it may be stripped on only one side for temporary or pressure connections.

It is possible to treat as many as 50 conductors as simply as a single wire in terminating and in stripping. Registering one conductor automatically registers all other conductors with mating contacts on printed wiring boards, connectors or another piece of Tape Cable.

Then, as a unit, all conductors can be dip-soldered in one operation. Edge dip-soldering of Tape Cable to printed wiring boards is readily automated for the assembly line. Harnesses and splices are completed in minutes. Complete assembly time of the 17 contact Elco connector shown is less than 3 minutes.

If you have a cable application that requires frequent or constant flexing, Tape Cable has unmatched advantages. The high flexibility of Tape Cable is the result of the extreme mechanical strength of the polyester insulation coupled with the fine grain texture of the thin copper conductors. Tape Cable has been used in applications requiring continuous flexing.

Tape Cable is available in 25, 100, 500 and 1,000 foot rolls.

**YOU MAY ORDER TAPE CABLE DIRECT FROM THIS SHEET**

All orders shipped with catalog and instruction booklet. Shipped Parcel Post from Rochester, N. Y. Postage prepaid.

Detailed information, samples, and assistance available from Tape Cable Corp. representatives in all sections of the U.S.A.

\*Tape Cable is a Trade Mark of the Tape Cable Corp. Pat. Pend.

LITHO U.S.A.

©

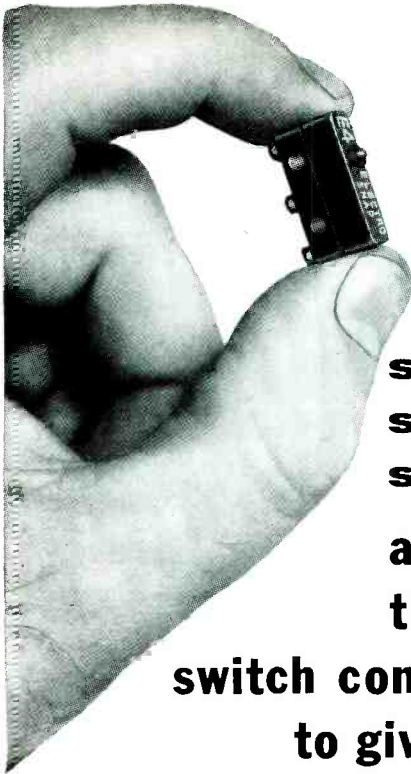

**sub-miniature  
snap-action  
switches . . .  
available in  
thousands of  
switch configurations  
to give you  
performance-proved  
standard switch economy**

The exceptionally varied configuration range of Electro-Snap "standard" subminiature switches today assumes new importance for engineers from the standpoints of both low cost and proven reliability. Whatever your requirements in operating characteristics, terminal arrangements, actuation means, etc., chances are that Electro-Snap can meet them exactly—either with a switch directly from stock, or with minor modification of one of the thousands of *performance-proved* Electro-Snap standards.

For your next project, check with Electro-Snap on economical, dependable standard, subminiature snap-action switches. Send your specifications today for our prompt recommendations and complete technical data. Write:

**ELECTRO-SNAP SWITCH & MFG. CO.**  
4236 W. Lake Street, Chicago 24, Ill.  
VA 6-3100 TWX #CG-1400

#### TERMINAL CONFIGURATIONS

(Available for all models)

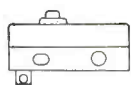

**STANDARD**—  
Cross drilled  
for solder  
wiring

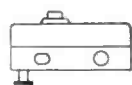

**TURRET**—For  
wrap-around  
solder wiring

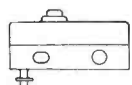

**DOUBLE-TURRET**—For  
multiple lead-in  
soldering

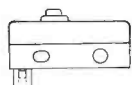

**QUICK-DISCONNECT**—  
Female tubular  
for std. AMP  
male disconnect  
term. connections

Choice of case material and oper. characteristics available with any terminal type.

#### SUB-MINIATURE BASIC SWITCHES (E4-100 Series)

**STANDARD**—(Model E4-103) Sub-miniature basic switch with ambient temperature of  $-65^{\circ}$  to  $+250^{\circ}$  F. (See other operating characteristics at bottom of page.)

**HIGH TEMPERATURE**—(Model E4-107) Ambient temperature of  $-65^{\circ}$  to  $+350^{\circ}$  F. (Diallyl Phthalate cases with high arc resistance; high impact strength.)

**HIGH CURRENT CAPACITY**—(Model E4-114) 5 amps. @ 30V., DC, Ind. Elec. life rating: 25,000 ops.

**ADJUSTABLE MOVEMENT DIFFERENTIAL**—(Model E4-507) mov. diff. can be adjusted from .002" to .0005", approx.; operating force from 200 to 100 grams, approx. Also adj. contact gap. Amb. temp  $-65^{\circ}$  to  $+350^{\circ}$  F.

Actual Size:

$2\frac{5}{32}'' \times \frac{1}{4}'' \times 2\frac{3}{64}''$

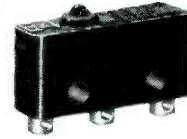

#### ENVIRONMENT-FREE SUB-MINIATURE BASIC SWITCHES (EF Series)

**SEALED BASIC SWITCH**—Approved on QPL—Mil. S. 6743 in accordance with dwg. Ms 25085-1.

**STANDARD**—(Model EF-3) sealed against dust, dirt, heat, humidity and cold. Shock and vibration resistant. Amb. temp.:  $-65^{\circ}$  to  $+180^{\circ}$  F.

**HIGH TEMPERATURE**—(Model EF-7) ambient temp. of  $-65^{\circ}$  to  $+325^{\circ}$  F. Internal switch case of Diallyl Phthalate with high arc resistance; high impact strength.

Actual Size:

$1\frac{5}{16}'' \times 1\frac{1}{32}'' \times 1\frac{9}{32}''$

(Standard switch  
has 12" leads)



#### SUB-MINIATURE BASIC SWITCHES (Slightly larger than E4-100 Series)

**LOW DEADBREAK**—(Model E4-58) features low deadbreak of .0005" max. Amb. temp.  $-65^{\circ}$  to  $+250^{\circ}$  F.

**LOW MOVEMENT DIFFERENTIAL**—(Model E4-31) Mov. diff. of .0005" max. Amb. temp.:  $-65^{\circ}$  to  $+350^{\circ}$  F.

**LOW OPERATING FORCE**—(Model E4-41) for applications where low oper. force is desired: 135 grams  $\pm$  5 grams. Mov. diff. .002"  $\pm$  .0005". Amb. temp.:  $-65^{\circ}$  to  $+350^{\circ}$  F.

Actual Size:

$2\frac{7}{32}'' \times .260'' \times 2\frac{3}{64}''$

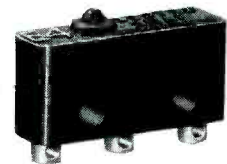

#### BASIC OPERATING CHARACTERISTICS

(Sub-miniature Switches—E4-100 Series)

Weight—.004 lbs.

Mech. life rating—150,000 ops.

Elec. Life ratings—

150,000 ops. @ 125/250 V., AC—2.5 amps.

100,000 ops. @ 125/250 V., AC—5.0 amps.

50,000 ops. @ 30 V., DC—2.5 amps.

50,000 ops. @ 30 V., DC—4.0 amps., res.

Approved on QPL, Mil. S. 6743 in accordance with dwg. MS 25085-1. UL Approved.

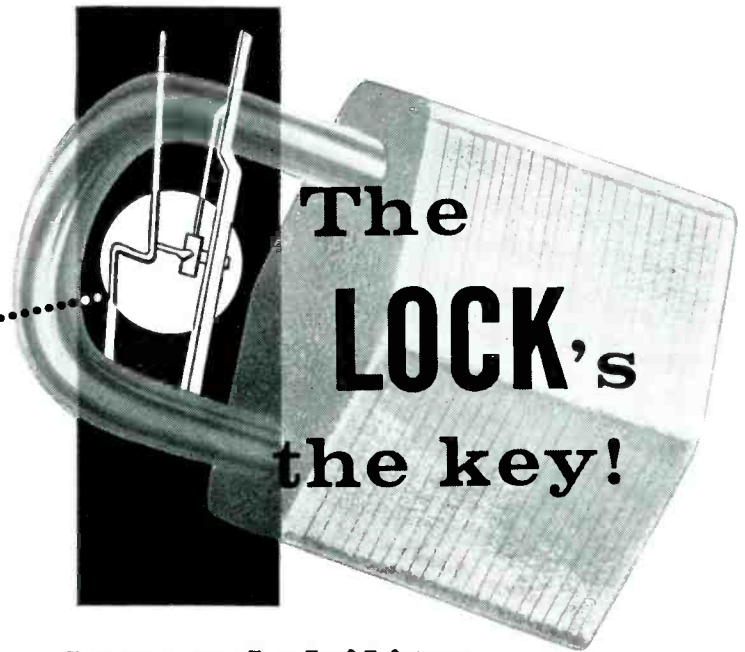
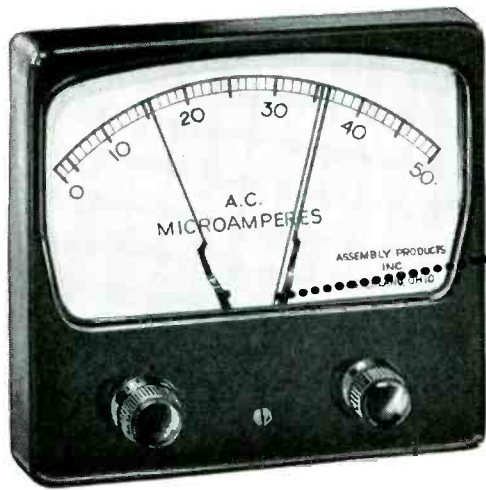

## ... to meter-relay dependability



The only truly dependable meter-relays are those built with locking contacts. For lasting, reliable contact action, meter-relay contacts *must* make firmly and break cleanly, every time.

An indicating meter with a couple of contacts stuck somewhere inside just won't do. Such an instrument may be excruciatingly accurate as an indicator, but it will fail miserably in a control application.

### LET'S CLEAR THE AIR

We make these statements because there seems to be some misunderstanding about how contact meter-relays should be built and what they will do. Since they are the very

### PRIMER STUFF, BUT PERTINENT

Any meter-relay which makes and breaks contacts by depending on the tiny forces inherent in a meter movement has been manufactured by whistlers-in-the-dark. Make and break must come from an auxiliary device. Without it, you'll get, at best, only a halting, exploratory type of contact. On the break, you'll get fluttering and arcing and probably sticking . . . at a point maybe 50% behind where the contact should have separated.

### HERE'S HOW LOCKING PAYS OFF

Properly used, locking coil contacts will operate reliably 10 to 20 million times. Non-locking contacts will do well to make it through 100,000 cycles, and this at greatly reduced contact current.

### GET YOUR MONEY'S WORTH

Meter-relays are used to do hundreds of jobs because they are extremely sensitive, indicating and adjustable. If you've never tried them, we wish you would. If you've tried them



heart of our business, we have the greatest concern for their reputation.

Indeed, we think everyone who has anything to do with meter-relays will benefit from a better understanding of them.



Trouble is, a meter movement alone won't do what it should

We use a locking coil to grab and hold the contacts. When they touch, there is no fooling . . . they close. The locking coil develops thousands of times as much press-together torque as the meter movement alone can generate. For positive separation, our meter-relays have a spring that loads when the contacts lock. When separation is desired, this spring unloads, flicking the contacts apart.



Operates 10,000,000 to 20,000,000 times

It is true that the need to unlock contacts sometimes presents circuit problems. But think of the problems if a meter-relay's contacts won't work at all! Then you don't have a meter-relay—simply a mighty expensive indicator.

and didn't make out so well, we'd like to have you try again.

In particular, try our locking coil types so you give meter-relays a fair shake—and do yourself a good turn in the bargain.



**ASSEMBLY PRODUCTS, INC., 75 Wilson Mills Road, Chesterland 4, Ohio**

Telephone: (Cleveland, O.) HAMILTON 3-4436 • TWX: Gates Mills, Ohio 25-U



# ALL VIDEO TRANSMISSION TEST

## STANDARDS in a suitcase



The Original Full Rack and the Portable Unit Produce the same Precise Test Signals.



**TELECHROME**  
INCORPORATED

### Model 1003-B

Video Transmission Test Signal Generator

- ★ Completely self contained ★ Portable
- ★ Multi-frequency burst ★ Stairstep ★ Modulated stairstep
- ★ White window ★ Composite sync ★ Regulated power supply.

Now, Telechrome Video Transmission Test Equipment is available as a completely portable 12 1/4" standard-rack mounting unit.

Everyday these Test Signals generated by Telechrome equipment, are transmitted Coast-to-Coast by NBC, CBS, ABC, the Bell System, Canadian Bell and leading independent TV stations throughout the U.S. and Canada. Hundreds of network affiliated TV stations and telephone TV centers thus check incoming video signals.

The compact, inexpensive, portable Model 1003-B is all that is required to generate signals for local and remote performance checking of your entire video, cable, or micro-wave facilities.

#### DELIVERY 30 DAYS

Literature on the above and more than 100 additional instruments for monochrome and color TV by TELECHROME are available on request.

The Nation's Leading Supplier of Color TV Equipment  
28 Ranick Drive Amityville, N. Y.

Lincoln 1-3600

**TELECHROME**  
INCORPORATED



**MULTI-FREQUENCY BURST AMPLITUDE vs FREQUENCY.**  
Check wide band coaxial cables, microwave links, individual units and complete TV systems for frequency response characteristics without point to point checking or sweep generator.



**WHITE WINDOW**  
**LOW & HIGH FREQUENCY CHARACTERISTICS.** Determine ringing, smears, steps, low frequency tilt, phase shift, mismatched terminations, etc. in TV signals or systems.



**STAIRSTEP SIGNAL** modulated by crystal controlled 3.579 mc for differential amplitude and differential phase measurement. Checks amplitude linearity, differential amplitude linearity and differential phase of any unit or system.  
Model 1003-C includes variable duty cycle stairstep (10-90% average picture level).

Model 608-A HI-LO CROSS FILTER for Signal analysis.



**MODULATED STAIRSTEP** signal thru high pass filter. Checks differential amplitude.



**MODULATED STAIRSTEP** signal thru low pass filter. Checks linearity.

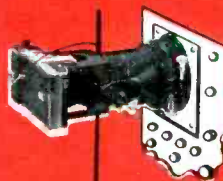

**1521-A OSCILLOSCOPE CAMERA**—Polaroid type for instantaneous 1 to 1 ratio photo-recording from any 5" oscilloscope.



**1004-A VIDEO TRANSMISSION TEST SIGNAL RECEIVER** for precise differential phase and gain measurements. Companion for use with 1003-B.

# What's *new* for you in **CANNON PLUGS**

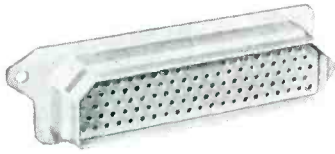

DPJ-33S



DPG-34P

- ▶ **Vibration**
  - ▶ **Moisture**
  - ▶ **Pressure**
- ▶ PROTECTION**

## with new **DPJ** and **DPG** Connectors

New DPJ and DPG Connectors feature sealing by means of a rubber seal around the insert faces. Exceptionally good protection against vibration and undesirable pressure and moisture conditions is provided. The DPG currently is available in 5 different insert arrangements, the DPJ with 3 insert layouts. Write for Bulletin DP-101 TODAY!

*new*



## "EX" SEALED CONNECTORS

- ▶ **No Potting Required**
- ▶ **Light weight**

New EX Connectors feature a monobloc silicone insert into which the contacts are inserted after wiring. When the endbell is tightened over the insert, the contacts are completely sealed . . . giving a sealed connector of minimum weight without potting.

EX plug assemblies are currently available in four shell configurations with socket contact inserts . . . EX05, EX06, EXG06 and EX08. They are basically identical with the exception of endbell variations in each case. EX plugs mate and seal with standard AN, AN-E, and GS type receptacles, and are available in practically all AN layouts using #12 or #16 contacts from sizes 8S to 28. Write for Bulletin PR-EX TODAY!

*new*



Available in square-flanged receptacle, Q02, and straight plug, Q06. Insert Diameters: 1/16", 1/8", and 1/4"

## "Q" MINIATURE CONNECTORS

- ▶ **Self-Locking**
- ▶ **Sealed**
- ▶ **Vibration Resistant**

Designed for control and instrumentation circuits of all types where space, vibration, moisture, or pressure conditions are limiting factors. Resilient grommets seal behind inserts . . . rubber sealing ring seals around the insert faces. Locking engagement accomplished by a beryllium copper latch within a spring loaded sleeve. Three shell sizes, with 7, 13, 19, 37 silver-plated brass 10-amp. contacts for #18 AWG wire. Alternate positioning. Cymel 592 insulators. External parts are cadmium plated aluminum. Hermetically-sealed, round-flanged receptacle, QH25, also available. Write for Q Miniature Bulletin TODAY!

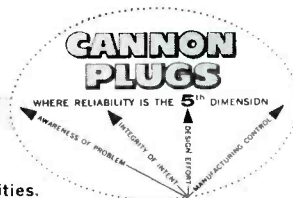

CANNON ELECTRIC CO., 3208 Humboldt St., Los Angeles 31, California.  
 Factories in Los Angeles, Salem, Mass., Toronto, London, Melbourne.  
 Manufacturing licensees in Paris, Tokyo. Representatives and distributors in all principal cities.



Please Refer to Dept. 120



# NEW LATCHING SUB-MINIATURE RELAYS

BURTON BROWNE/New York

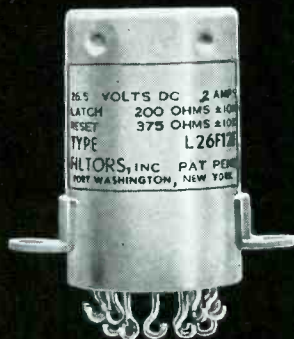

SMALLEST —  
LIGHTEST

## EXCLUSIVE

WITH FILTERS, INC.

*By Filtors,  
smallest and lightest  
hermetically sealed latching  
sub-miniature relays,  
magnetically held—  
no power drain—  
and electrically reset.  
2PDT, 4PDT and 6PDT*

*High shock and vibration  
resistance.*

*All made to  
MIL-R-25018 (USAF)  
and MIL-R-5757C.*

*Dry circuit relays available*

*Write for catalog*

*Leading manufacturers of  
hermetically sealed  
sub-miniature relays.*

## FILTORS, INC.

*Port Washington,  
Long Island, New York  
Port Washington 7-3850*

When you think of

# SILVER

Think of Handy & Harman

Because . . .

- Handy & Harman is the leading manufacturer of silver and silver alloys for industry.
- During 90 years in precious metals, Handy & Harman has helped develop many of the uses of silver by industry.
- Experience and research have established Handy & Harman as the Number 1 authority on silver.

This experience and knowledge is at your call. Whatever your silver requirements, Handy & Harman is anxious to be of service.

Here are some of the forms Handy & Harman manufactures:

- Fine Silver (wire, strip and foil)
- Silver anodes and grain for plating
- Silver contact alloys
- Silver powders
- Silver flakes and paints
- Silver brazing alloys
- Silver electronic solders
- Silver sintered metals
- Solder-flushed silver alloys
- Silver chloride and oxide
- Coin Silver (wire and strip)
- Silver Bi-metals

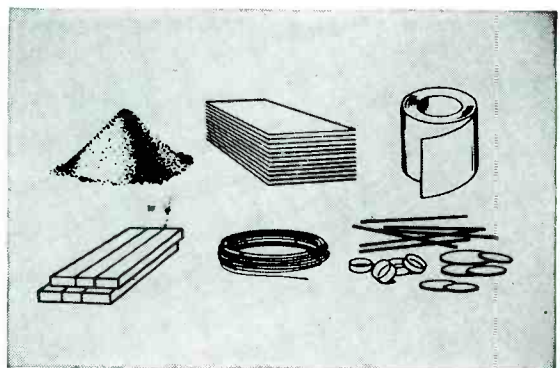

*For your information file*

We have four Technical Bulletins giving engineering data on the properties and forms of Handy & Harman Silver Alloys. We would like you to have any or all of those that particularly interest you. Your request, by number, will receive prompt attention.

- |                                      |              |
|--------------------------------------|--------------|
| Fine Silver . . . . .                | Bulletin A-1 |
| Silver-Copper Alloys . . . . .       | Bulletin A-2 |
| Silver-Magnesium-Nickel . . . . .    | Bulletin A-3 |
| Silver Conductive Coatings . . . . . | Bulletin A-4 |

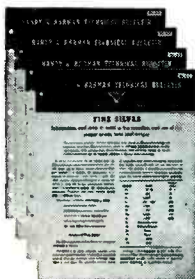

Your NO. 1 Source of Supply and Authority on Silver Alloys



**HANDY & HARMAN**

General Offices: 82 Fulton St., New York 38, N. Y.

OFFICES and PLANTS • BRIDGEPORT, CONN.  
 PROVIDENCE, R. I. • CHICAGO, ILL. • CLEVELAND,  
 OHIO • DETROIT, MICH. • LOS ANGELES, CALIF.  
 TORONTO, CANADA • MONTREAL, CANADA



Before ordering custom seals  
check the **E-I** standard line of

**glass-to-metal  
SEALS\***

— ranging from single leads to transistor closures

THE E-I STANDARD LINE includes sealed terminations for every electronic and electrical application. Standard compression type seals are available to meet the requirements of the grueling environments encountered in many military and commercial installations. For an economical service-tested solution to your sealing problem, consult E-I.

ENGINEER-DESIGNER CATALOG and Handbook available containing complete information on E-I standard terminals and custom sealing with helpful application and installation data. Call, or write on company letterhead, for your copy, now!

- Compression Seals
- Multiple Headers
- Sealed Terminals
- Condenser End Seals
- Threaded Seals
- Transistor Closures
- Miniature Closures
- Color Coded Terminals
- Custom Sealing

\*Canadian Pat. 523,390;  
British Pat. 734,583;  
U. S. Patent Pending  
All Rights Reserved

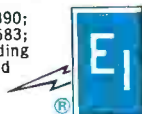

**ELECTRICAL  
INDUSTRIES**

MURRAY HILL, NEW JERSEY

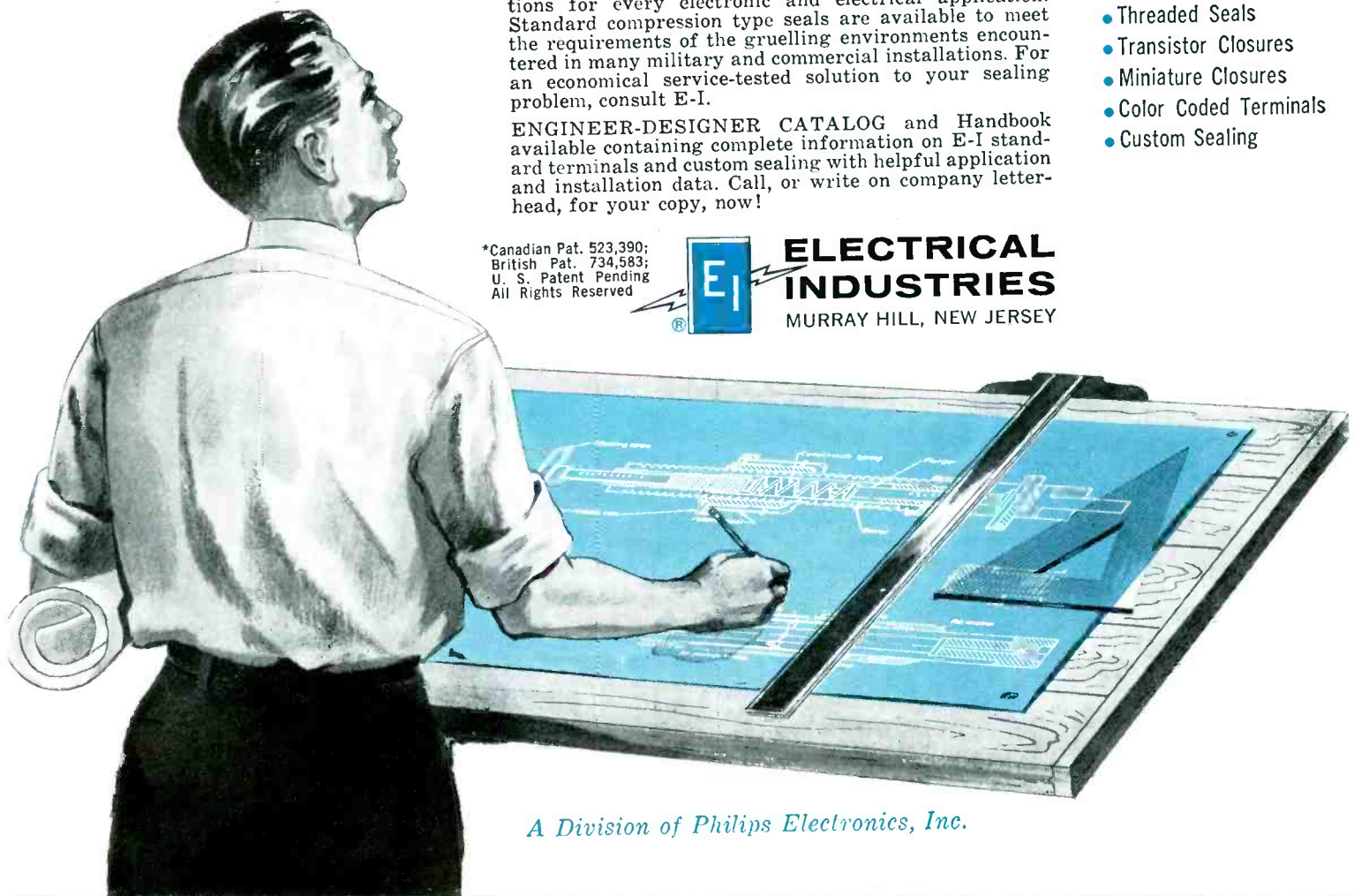

*A Division of Philips Electronics, Inc.*

VRL

presents an entirely

NEW

# ircuit omponent



## the V I B R I S T O R

**A SELF-RESONANT, SEMICONDUCTOR INTERRUPTER  
NO CONTACTS • NO MOVING PARTS • UNLIMITED LIFE**

### Completely Transistorizes Existing Power Supplies

- UNPLUG VIBRATOR, PLUG-IN VIBRISTOR. NO WIRING CHANGES REQUIRED.
- RIPPLE AND NOISE ARE EFFECTIVELY ELIMINATED.
- OUTPUTS AND OVER-ALL PERFORMANCE ARE UNCHANGED.
- NO DAMAGE RESULTS FROM ACCIDENTAL SHORTS OR OVERLOADS.
- OPERATING LIFE OF POWER SUPPLY IS UNLIMITED.
- 100% STARTING AND OPERATING RELIABILITY.
- SYNCHRONOUS AND NON-SYNCHRONOUS MODELS AVAILABLE.

### Revolutionizes New Equipment Design

- AVAILABLE FOR ANY FREQUENCY UP TO 100 KC.
- ALLOWS COMPLETE FREEDOM OF POWER TRANSFORMER DESIGN. ANY MAGNETIC MATERIAL MAY BE USED IN ANY CORE CONFIGURATION.
- MAGNETIC SATURATION OF POWER TRANSFORMER NOT REQUIRED.
- INVERTER FREQUENCY IS INDEPENDENT OF INPUT VOLTAGE.
- OPTIMUM PERFORMANCE OF SEMICONDUCTORS ASSURED.
- REDUCES NUMBER OF COMPONENTS — SIMPLIFIES MECHANICAL DESIGN.

MODEL NO.	TYPE	INPUT VOLTS	MAX. AVE. INPUT CURRENT (AMPS)	FREQ. (CPS)	MAX. DC OUTPUT VOLTS
VT603S	S	6	3	115	400
VT610N	N	6	10	115	—
VT123S	S	12	3	115	400
VT125S	S	12	5	115	400
VT241F	F	24	1.5	400	—
VT243F	F	24	3	400	—

S—Synchronous

N—Non-synchronous

F—Constant Frequency

**MANY OTHER MODELS AVAILABLE. DATA ON REQUEST.**

VRL, long a leader in the vibrator and vibrator power supply field, proudly announces a new and complete line of transistorized power supplies and associated equipment.

### OTHER PRODUCTS

- DC-AC Inverters — 400 cps  $\pm 1\%$  — up to 300 VA.
- DC-DC Converters — 6, 12, 24 volt input to any desired outputs, regulated or unregulated.
- DC and AC Voltage Regulators.

*VRL has pioneered literally hundreds of power supply developments over the past decade and offers a complete design, engineering, and manufacturing service. Send us your power supply requirements for quotation.*

**VIBRATION RESEARCH LABORATORIES INC.**

58 MARBLEDALE RD., TUCKAHOE, N. Y.



# General Electric 5-Star Tubes

## MADE LIKE A FINE WATCH FOR UNIFORM RELIABILITY!

**HEATER.** Wire is too critical in fineness to measure other than by weight... 4.5 mg per 200 mm. Maximum allowable weight variation is  $\pm 1\%$ .

**CATHODE.** Diameter .03 in, precision-held to  $\pm .0005$  in. Coating is restricted to a weight variation of  $\pm .25$  mg per sq cm.

**GRID WIRE.** Diameter .001 in, controlled by weight to  $\pm 15$  millionths of an inch. Grid No. 1, silver-plated tungsten—No. 2, gold-plated tungsten—No. 3, molybdenum.

**GRID TOLERANCES** (across minor axis):  
No. 1,  $\pm .0007$  in. No. 2,  $\pm .0007$  in. No. 3,  $\pm .002$  in.

**GRID SIDE RODS.** Held to  $\pm .00015$  in.

**MICA CATHODE-HOLE DIAMETER.** Held to  $\pm .00025$  in.

**MICA GRID-HOLE DIAMETER.** Held to  $\pm .0005$  in.

**MICA HOLE SPACING.** Cathode-to-grid aperture spacing is held to a max variation of  $\pm .00025$  in.



**G**ENERAL ELECTRIC 5-Star Tubes are specially built to the industry's highest standards of craftsmanship and precision. Micro-measurements of a representative type, 5654—a few of which are given above—show the extreme accuracy of manufacture that sets these fine tubes apart from others. 5-Star Tubes are the most reliable you can specify...and the most uniform in their dependability, tube-to-tube.

A wide range of 5-star high-precision, high-reliability types—miniatures and subminiatures—is available for critical military and industrial sockets. Contact the nearest office of the Receiving Tube Department, at right!

**ABOVE:** greatly enlarged sectional view of a General Electric 5-Star high-reliability 5654. This tube was taken from current production.

### EASTERN REGION

200 Main Ave., Clifton, N. J.  
Phones:  
(Clifton) GRegory 3-6387  
(N.Y. C.) Wl. 7-4065, 6, 7, 8

### WESTERN REGION

11840 West Olympic Blvd.  
Los Angeles 64, Calif.  
Phones: GRanite 9-7765  
BRadshaw 2-8566

### CENTRAL REGION

3800 North Milwaukee Ave., Chicago 41, Illinois  
Phone: SPring 7-1600

*Progress Is Our Most Important Product*

**GENERAL  ELECTRIC**

162-1CB

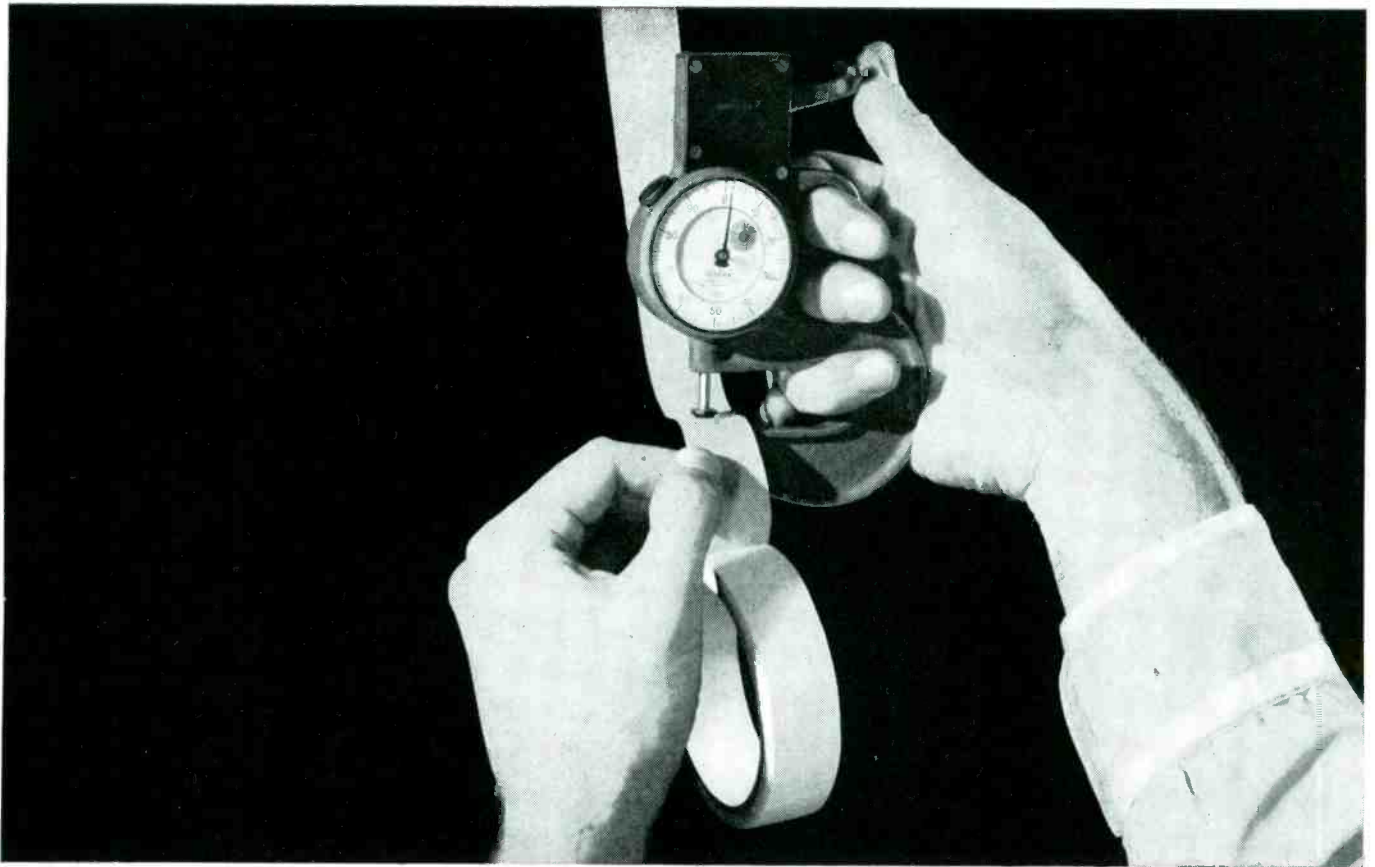

**TEMP-R-TAPE C** pressure sensitive, thermal curing and only .0015" thick provides the ultra-thin, easy-to-use, high dielectric tape with extreme temperature range long needed by electronic manufacturers.

## New TEMP-R-TAPE "C"

**Thermal curing pressure sensitive TEFLON\* tape  
.0015" thick, 2500 v/m, -100°F to 500°F temp. range**

CHR's new TEMP-R-TAPE<sup>®</sup> C is made with specially produced .001" cast Teflon film which provides dielectric strength higher than any other Teflon tape. To this ultra-thin backing, .0005" of thermal curing pressure sensitive silicone polymer adhesive is added. The result is a high dielectric tape (2500 v/m) which, when cured in place, has a -100°F to 500°F (-70°C to 260°C) operating temperature range and will withstand much higher temperatures for short periods of time.

As a pressure sensitive tape, TEMP-R-TAPE C is easy to apply. Once cured, it will not creep due to vibration. Curing TEMP-R-TAPE C requires only a short heat time cycle which can be varied to fit production schedules. Peel strength at room temperature is 18 oz./in. width when pressure sensitive — greater than the breaking strength of the Teflon once cured.

For complete information on TEMP-R-TAPE C and CHR's other extreme temperature pressure sensitive tapes, write today to the address below.

\*duPont TM

### Other TEMP-R-TAPES from CHR

TYPE	DESCRIPTION
T	Skived Teflon tape with pressure sensitive silicone adhesive. .006" thick, -100°F to 400°F (-70°C to 200°C) temperature range, 1500 v/m dielectric strength. Uses: Class H insulation, non-stick facing, mold release, etc. From stock. White and colors.
TH	Skived Teflon tape with pressure sensitive silicone adhesive. .013" thick, -100°F to 400°F (-70°C to 200°C) temp. range, 1100 v/m. Uses: Class H insulation, non-stick facing. From stock.
TG	Teflon impregnated fiberglass tape with pressure sensitive thermal curing silicone adhesive. .006" thick, -100°F to 500°F (-70°C to 260°C) temp. range when cured, 500 v/m. Uses: Class H insulation, non-stick facing. From stock.
SR	Silicone rubber coated fabric tapes available in a wide variety of constructions with or without pressure sensitive adhesive. -100°F to 500°F (-70°C to 260°C) temp. range. Uses: Class H insulation.
N	Nylon coated nylon fabric with pressure sensitive silicone adhesive. -100°F to 200°F temperature range. Uses: chafing strips and non-stick facing.



**THE CONNECTICUT HARD RUBBER CO.**

409 EAST STREET • NEW HAVEN 9 • CONNECTICUT  
LOS ANGELES • ST. LOUIS • SEATTLE

Airframe Seals • Coated Fabrics • Silicone Rubber Extrusions, Moldings, Sheet & Sponge



# SQUARE

away  
your space  
problems  
with

# DU MONT<sup>®</sup>

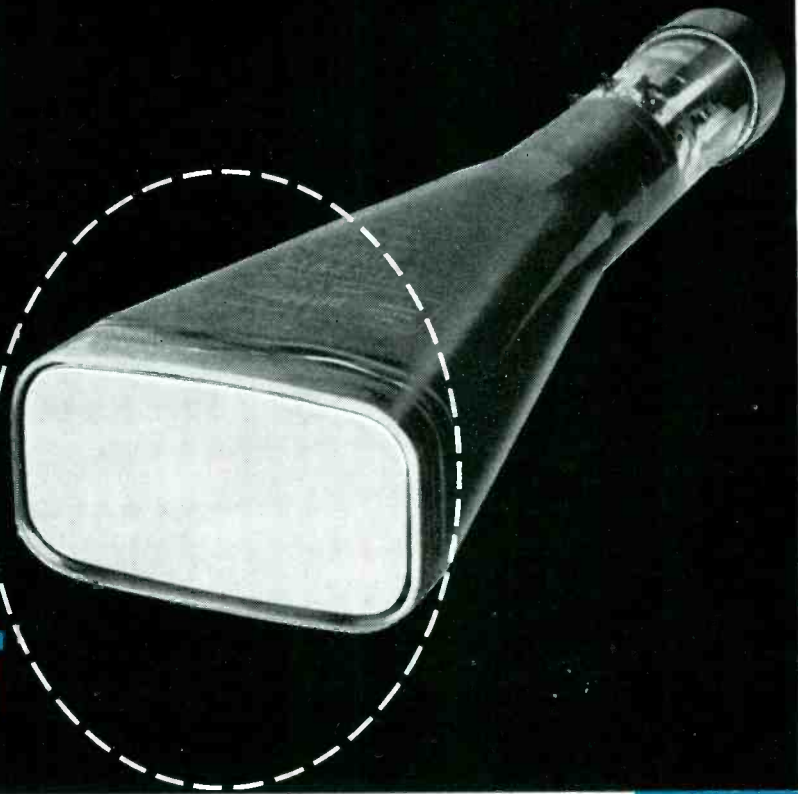

# RECTANGULAR

# CATHODE-RAY TUBES

Save valuable panel space by using Du Mont Rectangular Cathode-ray Tubes. These tubes permit a larger usable screen area in a given space by elimination of seldom-used segments of the circular screen.

Du Mont Rectangular Cathode-ray Tubes are available in electrostatic or electromagnetic types, in a wide range of screen sizes, shapes and materials. Write for complete technical details . . .



*Rectangular screen for display of single, or super-imposed patterns.*

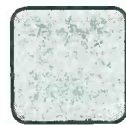

*Square screen for display of two signals on a single time base.*

	Tube Type	Screen Size	Focus	Deflection	Max. Anode Voltage	Length
DU MONT RECTANGULAR CATHODE-RAY TUBES	B1204	4 $\frac{1}{2}$ " x 2 $\frac{1}{2}$ "	Electrostatic	Electrostatic	6 KV	17 $\frac{1}{2}$ "
	K1206	3 $\frac{1}{2}$ " x 3 $\frac{1}{2}$ "	Electrostatic	Electrostatic	6 KV	12"
	B1167	6" x 7 $\frac{1}{2}$ "	Electrostatic	Electromagnetic	12 KV	10"
	B1194	3" x 1 $\frac{1}{2}$ "	Electrostatic	Electromagnetic	16 KV	10 $\frac{1}{2}$ "
	K1442	6 $\frac{1}{2}$ " x 6 $\frac{1}{2}$ "	Electrostatic	Electromagnetic	35 KV	12 $\frac{3}{16}$ "

INDUSTRIAL TUBE SALES, ALLEN B. DU MONT LABORATORIES, INC., 2 MAIN AVENUE, PASSAIC, NEW JERSEY

# SELECT CLOSURE HARDWARE TO IMPROVE UTILITY, APPEARANCE, AND TO LOWER COST

## QUICKLY INSTALLED SOUTHCO CAPTIVE PANEL SCREWS END MISALIGNMENT PROBLEM . . .

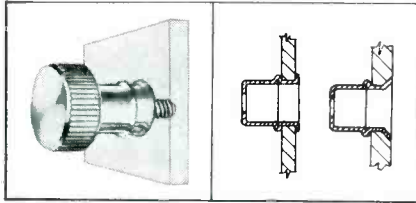

Simplicity of design contributes to clean, distinctive appearance and fast, low-cost installation. Stand-off is slipped into panel hole and secured by flaring. Screw is passed through stand-off and made captive by vinyl o-ring.

"Floating" screw design eliminates costly close tolerance manufacture and permits easy engagement regardless of panel distortion encountered under adverse use conditions.

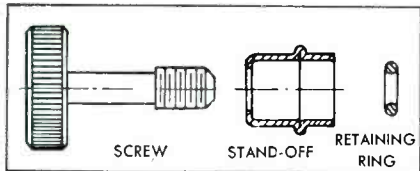

### SPECIFICATIONS

**Material:** Screw is brass, chrome plated; can be supplied in stainless steel. O-ring is vinyl plastic.  
**Overall length of screw:** 1 $\frac{3}{16}$ "  
**Depth of screw head:**  $\frac{1}{4}$ "

**Sizes:**

SCREW HEAD DIAMETER	THREAD SIZE
$\frac{3}{4}$ "	$\frac{1}{4}$ -20
$\frac{5}{16}$ "	$\frac{1}{4}$ -20, 12-24
$\frac{7}{16}$ "	10-24, 10-32

**Length of thread:**  $\frac{3}{8}$ "

Screw head is supplied plain, as shown, or slotted for screw driver.

## PRE-ASSEMBLED PAWL ADJUSTS TO DESIRED THICKNESS AND PRESSURE

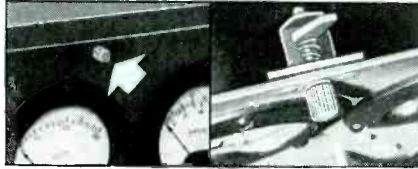

This neat, compact Southco panel and door fastener is supplied assembled, requires but two rivets or bolts for low cost installation. It is available in three models—large, intermediate and midget.

The unique feature of Southco Pawl Fasteners is the fact that, by merely turning the knob, the pawl is adjusted to a wide range of frame thicknesses. This assures a tight grip without precision setting regardless of variations in frame or door dimensions or changes that are produced by wear or warping of sheets.

Pressure exerted by the pawl on the frame is controlled in the same way, by merely turning the knob. Against gasketed frames, pressure can be easily applied to compress the gasket.

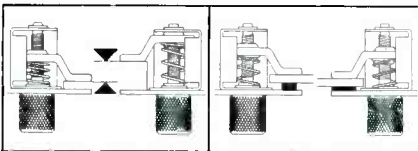

### SPECIFICATIONS

**Knob:** Cadmium or chromium plated steel.

**Head Styles:** Protruding ribbed or knurled knob; flush screw driver slotted for large size only.

	LARGE	INTERMEDIATE	MIDGET
Knob diameter	$\frac{7}{8}$ "	$\frac{5}{16}$ "	$1\frac{1}{32}$ "
Total width	2 $\frac{1}{2}$ "	1 $\frac{3}{4}$ "	1 $\frac{1}{8}$ "
Total height	1 $\frac{1}{16}$ "	$\frac{7}{8}$ "	$3\frac{5}{64}$ "
Back of panel depth	1 $2\frac{3}{32}$ "	1 $\frac{1}{4}$ "	$\frac{7}{8}$ "
Knob length	1 $\frac{1}{8}$ "	1 $\frac{5}{16}$ "	$\frac{9}{32}$ "

## FAST, HAMMER-DRIVEN BLIND RIVETS CUT INSTALLATION TIME

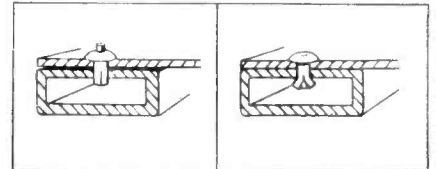

You "hit-the-pin" and the rivet's in. No special tools to limit production or require maintenance, no bucking, no finishing. For blind or open applications, Southco Drive Rivets save time, reduce costs.

Automatic "pull-up" action assures uniform, tight grip.

Southco Rivets are made of aluminum or cadmium plated steel with cadmium plated or stainless steel pins. Diameters are from  $\frac{1}{8}$ " to  $\frac{1}{4}$ ", grip range is from  $\frac{1}{16}$ " to  $\frac{3}{8}$ ".

Increased widespread use is due to low installed cost and elimination of down time and maintenance associated with fasteners requiring special tools.

## FREE! Fastener Handbook



Send for your free copy of Handbook No. 7, just released. Gives complete data for designers on these and many other specialty fasteners. 52 pages, in two colors.

Write on your letterhead to Southco Division, South Chester Corporation, 233 Industrial Highway, Lester, Pa.

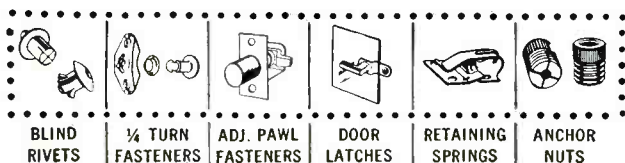

BLIND RIVETS

$\frac{1}{4}$  TURN FASTENERS

ADJ. PAWL FASTENERS

DOOR LATCHES

RETAINING SPRINGS

ANCHOR NUTS

**SOUTHCO FASTENERS**  
**LION**

©1957

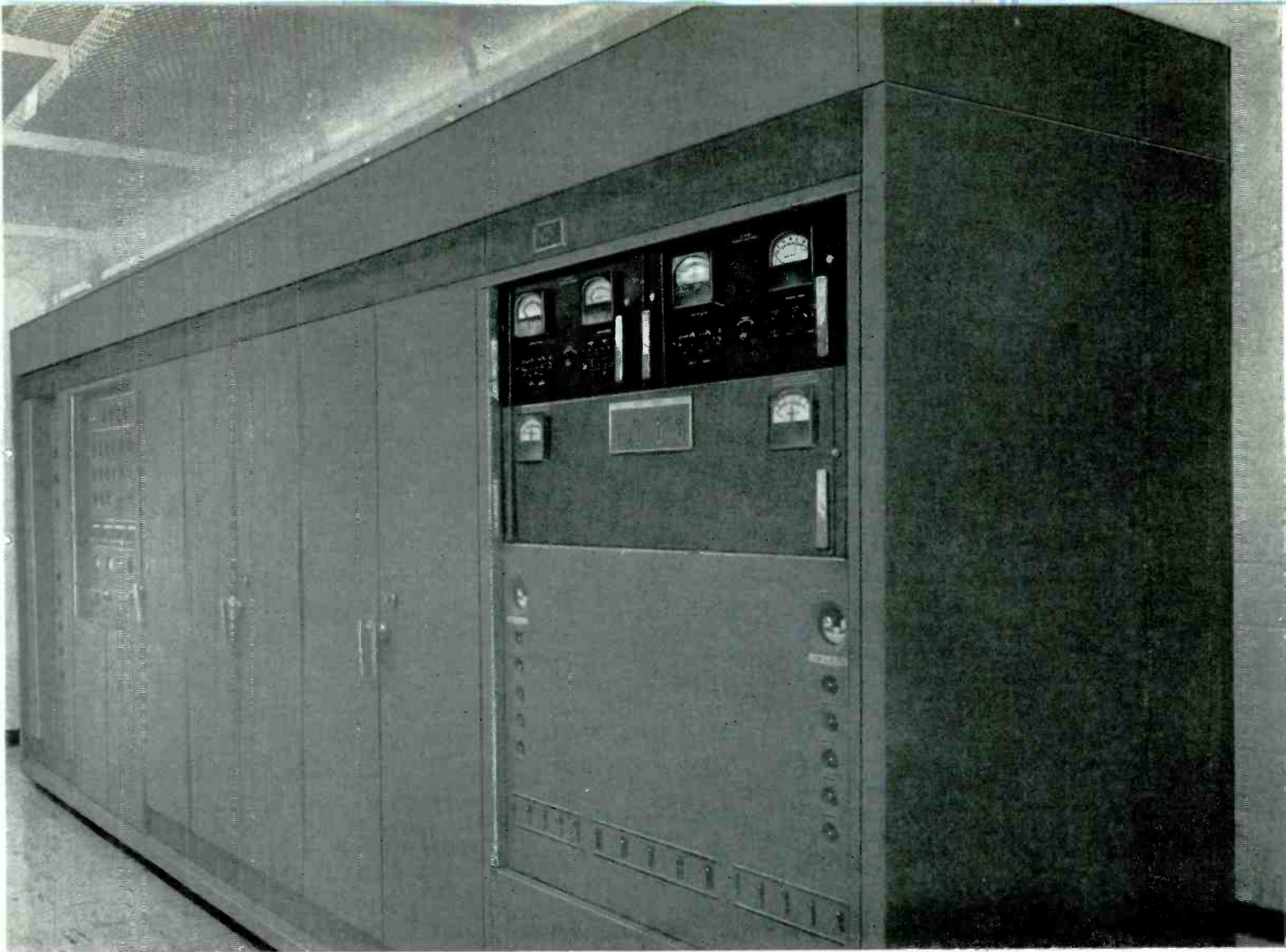

IBM stresses need for reliability

## Lambda power supplies used in SAGE computer

IBM's Kingston, N.Y., plant of their Military Products Division uses Lambda power supplies to provide the reference voltage for the marginal checking power supply system of the SAGE computer, the world's largest electronic digital computer.

The SAGE computer, whose power requirements are equal to that of a town of 15,000, must possess unprecedented reliability. It is designed to operate effectively 24 hours a day, seven days a week.

Every statistic compiled...every survey made by Lambda...has shown that Lambda power supplies are engineers' overwhelming choice, for industrial as well as military applications.

Write for the complete catalog of Lambda power supplies for all needs through 1.5 amperes. Rack, bench and portable models — for use as original equipment or components — for industrial, laboratory and military requirements.

### LAMBDA'S NEWEST COM-PAK<sup>®</sup> POWER SUPPLIES

Save valuable panel space • For all needs through 1.5 amperes  
Three voltage ranges: 0-200, 125-325, 325-525 VDC.

- C-200 series — 200 MA — 5 $\frac{1}{4}$ " panel height — from \$159.50
- C-400 series — 400 MA — 5 $\frac{1}{4}$ " panel height — from 244.50
- C-800 series — 800 MA — 7" panel height — from 315.00
- C-1500 series — 1500 MA — 8 $\frac{3}{4}$ " panel height — from 550.00



**LAMBDA Electronics Corp.**

11-11 131 STREET • COLLEGE POINT 56, NEW YORK  
INDEPENDENCE 1-8500

Cable Address: Lambdatron, New York

# BASIC RESEARCH . . .

## *More Practical Than You Think*

**This editorial, one of a special series on the importance of research to the American economy, deals with an aspect of our research program that may have serious consequences in future years — the lag in basic research.**

An earlier editorial in this series noted: "The keen interest of U. S. business firms in scientific research points the way to a new kind of prosperity for our economy — a prosperity based on deliberate creativeness." As a result of the dramatic increase in industry's research expenditures, more new products will be introduced in the years 1957-1960 than in any previous four-year period.

A steady stream of new products and new processes means better values for consumers and lower costs for business. And thus it promises to sustain a high level of general prosperity that defies the old laws of boom and bust. **But, as we look further ahead, there is a danger that the stream of research discoveries may run dry because of our neglect of basic research.**

This danger was described by John Jay Hopkins, late founder and chairman of the General Dynamics Corporation: "Unless there is a revolutionary development in America of pure, not applied, science, there will come a day when there is no use in trading in your old car; because the new one is no better. The only difference between this year's television set and next year's will be the appearance of the cabinet! Scientific progress will be replaced by scientific stagnation."

### **What Basic Research Is**

Basic (or pure) research has been characterized as the pursuit of knowledge for its own sake rather than to fulfill some practical objective. It is generally carried out in an environment which allows the in-

vestigator the freedom to follow the lead of his curiosity. The scientist in basic research, in the words of Glenn T. Seaborg of the University of California, is not concerned with "utilitarian goals, but a search for deeper understanding of the universe and the living and inorganic phenomena within it."

**Impractical as basic research may seem in its initial purpose, it is an essential prerequisite to applied research and product development.**

A few examples will show how some of the greatest technical advances of recent years have come from basic research projects that had no immediate practical objective:

- **Radar** — an important military development of World War II with broadening commercial applications — was the outgrowth of a basic research project whose purpose was to obtain information about the height of the ionosphere, the layer of air that lies some 25 miles above the earth's surface.

- **Transistors** — the miniature devices which are already vital components of hearing aids, pocket radios and a wide variety of industrial equipment — were invented at Bell Laboratories (research subsidiary of the American Telegraph and Telephone Company) following university investigations into the electrical behavior of solids.

- **Neoprene** — a synthetic rubber — was developed by duPont with the help of basic information provided by Father Nieuwland of Notre Dame, who discovered he could control the polymerization (the linking together of molecules) of a certain class of organic compounds.

- **Nylon** — the first of the noncellulosic synthetic fibers that have revolutionized the textile industry — grew out of fundamental research by Dr. Wallace Carothers on long-chain polymers.

## Only 8% of All Research and Development in the U. S. is Devoted to Basic Research

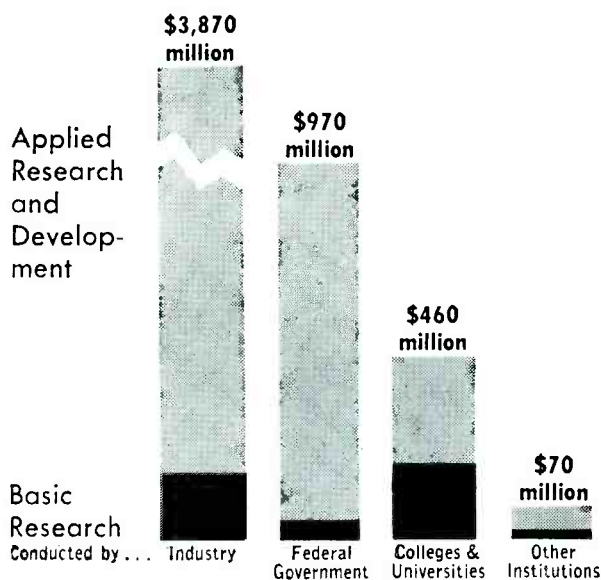

Data: National Science Foundation, "Funds for Basic Research in the United States, 1953"

### Industry's Stake in Basic Research

Industry traditionally has relied upon colleges and universities and other nonprofit institutions for basic research; and the U. S. has long benefited from the greater emphasis placed on basic research in Europe. It is conventional to think that business cannot, and should not, do much about "ivory tower" projects which do not have immediate practical application.

However, there is not so much in this idea as is supposed. The examples above illustrate what Caryl Haskins, president of the Carnegie Institution, has called "the widespread paradox that the most important practical consequences are commonly the least sought after." Furthermore, it is certain that, without adequate basic research, industry's efforts to produce new and better products will become progressively more difficult. And our national defense, in an age of breathtaking military applications of science, will become increasingly precarious.

In the past, our economic growth came largely through expansion into new lands or through discovery and development of rich deposits of natural resources. Such opportunities are relatively limited today. The great opportunities now lie in discovering new materials and new properties of the materials we already have. **This is the job of basic research, and industry has a vital stake in it.**

The chart indicates the tiny share of research efforts in the U.S. that is devoted to basic research. **Only 4% of all research by industry, and only 8% of all research in the U.S., during the year 1953**

(the latest for which information is available) represented fundamental research to add to overall scientific knowledge. Even in colleges and universities less than half the research performed is basic research. At least one Nobel Prize winner has expressed the belief that we need and should work toward a doubling of the proportion of our total research effort that is devoted to basic research as soon as possible.

### What Business Can Do

Without anything like a staggering increase in the total cost of its research programs, industry could do much to expand our basic research effort. Companies with big research programs should, as a matter of successful survival, be devoting a share of the effort in their own laboratories to basic research. Significantly, companies that are already doing a notable job of basic research have also made an outstanding record of translating such research into new products for industry and the consumer.

Smaller companies may rightly regard the conduct of research projects with uncertain prospects of reward as a luxury. Some basic research, indeed, never results in any tangible payoff. But, with modest contributions, small companies can still have a part in the advance of basic research. They can join together with other companies on cooperative projects. They can support basic research through trade associations and technical societies. They can help research centers in universities and other nonprofit institutions. Arrangements are available in some instances whereby business firms can pay a fee to have access to work done by university researchers.

**One way or another, it is up to private business firms to see that basic research moves forward. By doing so they will be laying the groundwork for the development of the new products and technology on which their growth, and the growth of the economy, depend.**

*This message is one of a series prepared by the McGraw-Hill Department of Economics to help increase public knowledge and understanding of important nation-wide developments. Permission is freely extended to newspapers, groups or individuals to quote or reprint all or parts of the text.*

*Donald C. McGraw*  
PRESIDENT

**McGraw-Hill Publishing Company, Inc.**

When you need  
Reliable Control  
of Intermittent Operation

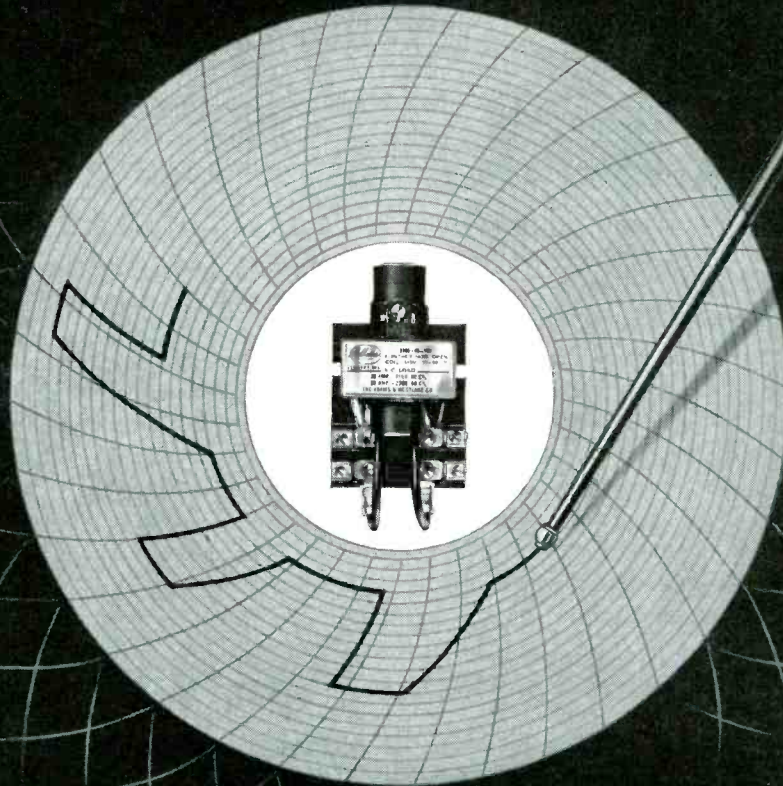

you need **Adlake**  
*mercury-to-mercury*

relays

- Mercury-to-Mercury contact of Adlake Relays gives ideal snap-action with no pitting, sticking or burning.
- Hermetically sealed at the factory so dust, dirt, moisture cannot affect them.
- Time delay characteristics are fixed and tamper-proof.
- Adlake Relays are quiet, chatterless and require no maintenance whatever.

If you have a control problem, our engineers will be happy to help you solve it. There's no obligation. Write The Adams & Westlake Company, 1171 N. Michigan, Elkhart, Indiana.



The Adams & Westlake Company  
NEW YORK ELKHART, INDIANA CHICAGO  
original and largest manufacturers of plunger-type relays

McGraw-Hill Publishing Company, 330 West 42nd St. New York 36

**A**

Acoustic controls tv sets.....156 Mar  
 Adding, computer, two-collector transistor used for binary addition.....214D Oct  
 AFC, triangular search sweep.....178 Nov  
 AGC, noise gating tube.....172 May  
 Airborne infrared warning system measures range, Osborne.....190D June  
 Airborne searchlight uses electronic controls.....190D June  
 Aircraft communications methods studied.....194D Apr  
 Aircraft radiophone speeds communications, Rashkov.....164 Apr  
 Air-drop system broadcasts message, Fischer, Gerlach & Schover.....179 Mar  
 Air-ground data link to cut stacking.....194D May  
 Alarm, antenna, DEW line.....216D Oct  
 Alarm, auto. ship.....180 Feb  
**Alignment & Balancing Techniques**  
 Portable voltage ratio calibrator for aircraft transducers.....232D Jan  
 Tape aids balancing of servo rotors.....254D July  
 Aluminum, ultrasonic iron solders.....168 Oct  
 A-M programming small stations.....146 Feb  
**Amplifier, see also type, audio, pulse, video, etc.**  
 Amplifier, antenna multicoupler.....176 Apr  
 Amplifier, bathythermometer, transistor.....194D July  
 Amplifier, chopper-stabilized.....175 Jan  
 Amplifier, corona.....198D July  
 Amplifier, d-c. stabilization of.....178 Jan  
 Amplifier, electro-optical.....210D Aug  
 Amplifier, ferro, core tester.....150 Aug  
 Amplifier, high-power.....170 July  
 Amplifier, inverter, using transistors in supply to power Vanguard rocket.....203D Apr  
 Amplifier, logarithmic 50-db.....214D Jan  
 Amplifier, logarithmic, measures noise.....169 Apr  
 Amplifier, logarithmic, used in measuring corona.....172 Mar  
 Amplifier, magnetic used in ma.....204D Jan  
 Amplifier—modulator, low distortion.....180 Sept  
 Amplifier, oscilloscope.....202D Jan  
 Amplifier, power, for servo testing.....176 May  
 Amplifier, power, used in air-drop system to broadcast messages.....179 Mar  
 Amplifier, r-f transistor driven.....214D May  
 Amplifier, r-f, platinotron increases search radar range.....164 Aug  
 Amplifier selectivity curves, Quandt & Sanders.....188 Aug  
 Amplifier, semiconductor, low transit time.....190D Sept  
 Amplifier, silicon transistor, temperature compensation of.....184 July  
 Amplifier, transistor, chopper-type, d-c. used in missile telemeter.....170 May  
 Amplifier, transistor, for guidance system used on chicken farms.....156 Feb  
 Amplifier, transistor, for medical recording.....161 Aug  
 Amplifier, transistor, null detector.....184 Feb  
 Amplifier, transistor, thermistors compensate.....169 Jan  
 Amplifier, transistor, used in audio induction paging system.....178 Feb  
 Amplifier, transistor, used in basic logic circuits.....196 Mar  
 Amplifier, transistor, used with crystal pickups.....181 May

Items for which the page reference is marked "D" are editorial material published monthly in *Electronics at Work and Production Techniques*.

Amplifiers, magnetic, used in high-speed digital computer.....156 Aug  
**Analog Computer, see also computer**  
 Analysis, circuit, select c-w phase.....202D June  
 Analysis, medical, cardiac.....202D June  
 Analyzer, pulse, reject voice signals.....183 Apr  
 Analyzer, wide-range, curves.....184 Mar  
 Anomalous propagation.....224D Apr  
 Antenna alarm anticipates ice on DEW line.....216D Oct  
 Antenna, solar-flare detection.....162 Mar  
 Antenna, balloon, mobile radar.....198D Nov  
 Antenna, beacon, for missiles.....166 Mar  
 Antenna multicoupler, amplifier.....176 Apr  
 Antenna-multiplex system design, Schlegelmilch, Nilssen & Pan.....148 July  
 Antenna, radar, horsepower nomograph for rotators.....188 Jan  
 Antenna, ridge vane, provides constant beamwidth.....196D Nov  
 Antenna, sleeve radiator.....208D Mar  
 Antenna test chamber.....212D Sept  
 Antenna, transmitter changeover.....138 Sept  
 Antennas, ferrite rod X-band.....159 Jan  
 Antennas, microwave, decoupling.....204D June  
 Applications of corona effects, Tombs, Chatterton & Galpin.....198D July  
**Array, see also antenna**  
 Array, X-band antenna, for guided missiles.....166 Mar  
 Array, S-band antenna, for guided missiles.....166 Mar  
 Artificial ionosphere.....194D July  
**Assembly Techniques**  
 Antenna support.....268D Jan  
 Assembling two-piece vacuum-molded high-fidelity horns.....230D Jan  
 Blow-loading machine puts inserts in molds.....258D Oct  
 Coated-filler resin speeds encapsulation, Herr & Casement.....258D Aug  
 Cool ultraviolet shows fungicidal varnish during application.....230D Feb  
 Conductive films.....259D Sept  
 Double-deck parts cart.....238D Dec  
 Epoxy adhesive kit.....240D Dec  
 Expendable wipers clean crystal machines.....256D Oct  
 Jig transits speed antenna tower welding.....242D Feb  
 Handling rack for magnetic cores.....254D Jan  
 Hard-anodizing gives insulation on aluminum.....246D Dec  
 Inserting r-c networks in plated wiring boards.....260D Sept  
 Machine inserts components in boards.....238D Nov  
 Mark-sensing cards aid quality control on tacan assembly lines.....232D Feb  
 Hazard.....236D Nov  
 Molding pressure seals.....236D Nov  
 Nylon-insert screws replace locking cement.....254D Nov  
 Packaging diodes for bridge rectifier.....258D Apr  
 Plastic cases protect airborne radar jammers.....252D Feb  
 Portable self-feeding power screw-driver uses cartridge loads.....224D July

Press crimps metal electrode over ceramic.....259D Mar  
 Press speeds assembly of selector switch.....244D Sept  
 Reciprocating filer remover flash in side welded waveguides.....224D Sept  
 Rollers in viewer hold large circuit diagrams.....254D Mar  
 Rubber mat for bench protects assemblies.....234D Jan  
 Stacking stator laminations of servo motors.....228D Sept  
 Thread insert speeds probe tip assembly.....250D Jan  
 Three-D packaging for circuits, Werber, Jr.....144D Nov  
 Turntable speeds assembly of panels.....246D Aug  
 Weider locks turns on tape core winder.....274D Mar  
 Wrappable magnetic foil shields relay.....238D Nov  
**Atmospheric effects on propagation.....208D Mar**  
 Atomic flashlight burns years.....198D Feb  
 Attenuator box errors, Bishop.....216D June  
 Attenuator, microwave, printed circuit.....216D Mar  
 Attenuator, pulse, for cro displays.....218D Aug  
**Audio, see also sound, sonic, a-m, f-m**  
 Audio clipper extends coverage seals.....204D Feb  
 Audio, endless receiving device.....200D Jan  
 Audio delay-line.....200D May  
 Audio induction paging system, Zuck.....178 Feb  
 Audio, response of crystal pickups.....181 May  
 Audio, transistor phonograph preamplifier.....204D May  
 Audio, transistorized mixer.....248D Oct  
 Autoalarm, ship.....180 Feb  
 Automatic changeover of radio transmitters, Greenwood.....138 Sept  
 Automatic data plotter for f-m/f-m telemetering, Riblet.....182 Aug  
 Automatic level controls for tv slide chains, Lambourne.....182 July  
 Automatic programming in small a-m stations, Miller.....146 Feb  
 Automatic pulse width control, Porter.....200D Apr  
**Automation, see also control, computer**  
 Avoiding blown fuses with capacitive loads, Bernstein.....218D Nov

**B**

Back window cathode ray tube, Dieger.....202D Nov  
 Balancing automobile engines.....208D Nov  
 Basic logic circuits for computer applications, Booth & Bothwell.....196 Mar  
 Bathythermometer amplifier, Cawley, Jr.....194D July  
 Bathythermometer telemeters ocean data, Snodgrass & Cawley, Jr.....142 May  
 Batteries, miniaturization of electronic equipment—special report.....196 Oct

Beacon antennas for guided missiles, Barrick & Brannon ..... 166 Mar  
 Beacon, for guided missiles, ..... 144 Apr  
 Beacons, Vortac, for rho-theta navigation ..... 156 June  
 Binary-decimal counter operates at 10 mc, Cottrell ..... 186 Nov  
 Blowers, miniaturization of electronic equipment—special report ..... 194 Oct  
 Boiler analysis by remote control, 212D Mar  
 Boosting transistor switching speed, Baker ..... 190 Mar  
 Bridge, chopper-stabilized ..... 175 Jan  
 Bridge sorts capacitors to tolerance, Breskend, Cooperman & Franklin ..... 177 July  
 British atomic research uses tv ..... 214D Mar  
 British color tv tests ..... 198D Jan  
**Broadcast, see also f-m, a-m, television**  
 Broadcast, automatic changeover of radio transmitters ..... 138 Sept  
 Broadcast, color tv, sync generator for dot-interlace tv ..... 170 Aug  
 Broadcast, Conelrad control ..... 190D Jan  
 Broadcast, generator for sbb system ..... 152 Feb  
 Broadcast, monochrome slides broadcast color ..... 200D July  
 Broadcast modulation monitor, Mit-chum ..... 169 Mar  
 Broadcast, radio receiver design simplified by tetrajunction transistor, 148 Apr  
 Broadcast, simultaneous color tv test signal and equipment ..... 146 May  
 Broadcast, tape recorder selects radio announcements ..... 158 Oct  
 Broadcast, time signal, sets electric clock ..... 174 July  
 Broadcast, tower air monitor ..... 190D Jan  
 Broadcast, transmitter circuits for suppressed carrier a-m ..... 128 Dec  
 Broadcast, tv, automatic level control for tv slide chains ..... 182 July  
 Broadcast, tv, intercarrier receiver indicates failure ..... 188 Mar  
 Broadcast, tv, motion minimizes image orthicon burn-in ..... 180 Aug  
 Broadcast, tv receiver, noise gating tube for a/c and sync ..... 172 May  
 Broadcast, tv, transistors boost video for studio monitors ..... 205 Oct  
 Buoy telemeters ocean temperature data, Walden, R. G. Ketchum & Frantz, Jr. .... 164 June

**C**

Cables and connectors, miniaturization of electronic equipment—special report ..... 186 Oct  
 Cables, location detection of, by magnetic field pickup ..... 156 Sept  
**Calculator, see also computer**  
 Calibration, receiver ..... 194D Sept  
 Camera, portable tv, transistors syn-chronize ..... 168 Sept  
 Camera, recording, used in training radar observers ..... 146 Sept  
 Camera, television miniature itv uses drift transistors ..... 138 Jan  
 Camera, tv, motion minimizes image orthicon burn-in ..... 180 Aug  
 Cameras, oscilloscope, focusing of, 192D Sept  
 Canada gains computing center ..... 210D Mar  
**Capacitance, see also capacitor**  
 Capacitance, interelectrode, measurement by means of tester ..... 220D Apr  
 Capacitance pickup measures small forces, Dimeff & Fryer ..... 143 Feb  
 Capacitor insulation resistance ..... 214D July  
 Capacitors, by vacuum evaporation ..... 270D Nov  
 Capacitors, sorting to tolerance ..... 177 July  
 Cardiac analysis ..... 202D June  
 Cartridges, phono, compliance meter tests ..... 206 Oct  
 Cascade auto preamplifier, Wirth ..... 234D Oct  
 Cathode ray tube, back window type ..... 202D Nov  
 Cathode ray tube, deflection circuit for has high efficiency ..... 172 Apr  
 Cathode ray tube, tristable gate moves cro line drawings ..... 178 May  
 C-D alarm ..... 218D Mar  
 Ceramic, pickup, preamplifier for ..... 200D Aug  
 Chains, tv film and slide, automatic level control for ..... 182 July  
 Charts simplify passive d-c filter design, White ..... 210 Dec  
 Charts, waveguide loss ..... 210 Oct  
 Checker, tube, grid emission ..... 238D Mar  
 Choke, wide-swing ..... 202D Nov  
 Choosing materials for heat-resistant radomes, Pierson ..... 256D Nov  
 Chopper, silicon diode, stabilizes d-c amplifier ..... 178 Jan  
 Chopper-stabilized operational amplifier bridge gages high capacitance, 175 Jan  
 Chromatography, gas, control ..... 164 Nov  
 Chronograph times supersonic models, Kerwin ..... 152 Apr  
 Circuit, cascade, uses auto preamplifier for low level r-f and audio application ..... 234D Oct

Circuit components, miniaturization of electronic equipment—special report ..... 188 Oct  
 Citizen radio frequency, remote control receiver ..... 149 Feb  
 Clamp, diode, nomograph ..... 188 Sept  
 Clamp-on microammeter measures a-c current, Montgomery & Stansbury ..... 162 Dec  
 Clip-on milliammeter uses magnetic amplifier, Frei ..... 204D Jan  
 Clipper, audio, extends transmitter coverage ..... 204D Feb  
 Clock, crystal, for computer ..... 196D June  
 Clock, electric, set by time-signal broadcast ..... 174 July  
 Cloud detectors for earth satellite ..... 218D Oct  
 Coaxial line impedance chart, Levin ..... 190 Nov  
 Coaxial stub design, Young ..... 188 July  
 Code, Morse-to-teletypewriter ..... 154 July  
**Coil Production Techniques**  
 Coil-coating machine applies butyrate tire ..... 248D July  
 Coil winder for miniature toroids, Geodykoontz ..... 256D Jan  
 Drying toroid cores ..... 264D Oct  
 Impregnating toroids for high temperatures, Deimel ..... 240D June  
 Installing coils in servo motor stator ..... 252D Sept  
 Pecan-shell blast removes enamel from coils on conveyor ..... 252D Mar  
 Plug-in toroid assembly techniques, Rose ..... 260D Mar  
 Rubber pad saves transformer coils ..... 274D Oct  
 Winding servo motor coils on aluminum take-apart mandrel ..... 224D June  
 Coils, pickup, used in chicken farm guidance system ..... 156 Feb  
 Coincidence circuit, magnetic core, 194D Aug  
 Color tv, flat tube for ..... 190D Feb  
 Color tv, monochrome slides broadcast color ..... 169 Mar  
 Color tv system uses flying-spot scan, Mate ..... 138 Feb  
 Colorimeter, Bi, used for broadcasting color from monochrome slides ..... 169 Mar  
 Communication, a-f induction ..... 180 June  
 Communication, speech compressor ..... 168 Feb  
 Communications, aircraft, air-ground data link to cut stacking ..... 194D Apr  
 Communications, aircraft, methods studied ..... 194D Apr  
 Communications, aircraft, speed of by radiotelephone ..... 164 Apr  
 Communications, artificial ionosphere ..... 194D July  
 Communications, below 30 mc, noise measurement of by logarithmic amplifier ..... 169 Apr  
 Communications, call letters ..... 224D May  
 Communications, German railway semaphores replaced by radio ..... 194D Jan  
 Communications, ionospheric ..... 144 June  
 Communications, mobile ..... 214D Feb  
 Communications, Morse-to-teletypewriter code converter ..... 154 July  
 Communications, probability computer measures atmospheric noise ..... 208 Oct  
 Communications, radio link uses meteor trails ..... 192D Aug  
 Communications, receiver, distributed amplifier as antenna multicouplers ..... 176 Apr  
 Communications, scatter, transmitter tuned by distortion indicator ..... 180 Sept  
 Communications, single sideband links Canadian traders ..... 174 Oct  
 Communications, superregenerative 6-meter transistor transceiver ..... 180 Apr  
 Communications, telephone, rural carrier system uses transistors ..... 146 Aug  
 Communications, thyratrons oust rotary selector in mobile phone ..... 150 Nov  
 Communications, transistor multiplex radio-teletypewriter ..... 150 Sept  
 Communications, tv industrial, slow-scan adapter for conventional tv signals ..... 153 June  
 Compact supplies have wide-range regulation, Schreiber ..... 168 Dec  
 Components, miniaturization of electronic equipment—special report ..... 188 Oct  
 Components, high temperature ..... 158 May  
 Components, radiation effects ..... 244D Mar  
 Compensating silicon transistor amplifiers, Gordon ..... 184 July  
 Compliance meter tests phono cartridges, Kopp ..... 206 Oct  
 Compounds, semiconducting ..... 144 Nov  
 Compressor, instantaneous speech ..... 168 Feb  
 Computation, circuit uses silicon diodes as logarithmic converter, 196D Aug  
 Computer, analog-digital, used in Morse-to-teletypewriter code converter ..... 154 July  
 Computer, basic logic circuits for ..... 196 Mar  
 Computer, counters select drum sectors ..... 161 Apr  
 Computer delay unit uses semiconductor, Seism ..... 173 July  
 Computer, digital printer ..... 182 June  
 Computer, digital, unijunction transistor forms flip-flop ..... 165 Sept  
 Computer, for noise measurement ..... 208 Oct  
 Computer, high-speed digital ..... 156 Aug  
 Computer, stores 2.5 magabits ..... 162 Oct  
 Computer inventories oil in refinery tanks, Gimpel & Barton ..... 143 Oct  
 Computer, puncher transcribes computer output ..... 164 Dec  
 Computer selects premium bond winners, Hayward, Bubb & Fensom ..... 138 July  
 Computer solves power dispatch problem ..... 144D Feb  
 Computer techniques used in ship autoalarm ..... 180 Feb  
 Computer, two-collector transistor for binary full addition ..... 214D Oct  
 Computers, digital, checking ..... 206D Sept

Computers, ferrite cores of memory planes, printed wiring ..... 160 June  
 Computers, read-out device ..... 216D Sept  
 Computers, storage technique ..... 216D Sept  
**Condenser, see also capacitor**  
 Condenser size and spacing for printed circuits, Merson ..... 178D Dec  
 Control, air traffic, microwave remote aid ..... 144 July  
 Control, airborne searchlight ..... 190D June  
 Control, automatic changeover of radio transmitters ..... 138 Sept  
 Control, automatic, programming in small a-m stations ..... 146 Feb  
 Control, automatic, pulse width ..... 200D Apr  
 Control, checking tube vibration ..... 224D Feb  
 Control, circuit, for fuel injection ..... 192D Feb  
 Control, crowbar, transmitter ..... 175 June  
 Control, demodulator limiter ..... 156 Sept  
 Control, medical, iron-lung ..... 180 July  
 Control, oven thermostat ..... 232D Oct  
 Control, power, low-mu triodes ..... 204D Aug  
 Control, projector synchroism ..... 143 Sept  
 Control, radio, navigation trainer ..... 172 Sept  
 Control, radio, used in toys ..... 190D Sept  
 Control, reactor, uses transistors ..... 246D Oct  
 Control, radio announcements ..... 158 Oct  
 Control, temperature gas ..... 164 Nov  
 Control, temperature, crystals ..... 164 Feb  
 Control, transistorized lab relay ..... 169 Aug  
 Control, ultrasonic, gong, tv ..... 156 Mar  
 Control, video recording, used in tape recorder with revolving heads ..... 138 Aug  
 Controlled flash helps land planes, 192D Apr  
 Conelrad control ..... 190D Jan  
 Conversion formulas for hybrid parameters, Sylvan ..... 188 Apr  
 Conversion, logarithmic ..... 196D Aug  
 Converter, conventional tv signal into slow-scan signal ..... 153 June  
 Converter, Morse-to-teletypewriter code ..... 154 July  
 Cooling, electronic equipment ..... 194D Nov  
 Cordless audio receiving device ..... 200D Jan  
 Core, magnetic, coincidence circuit, 194D Aug  
 Core tester simplifies ferro-amplifier design, Roberts & Horstman ..... 150 Aug  
 Cores, ferrite, memory plane ..... 160 June  
 Cores, material ..... 156 Aug  
 Corona, effects, applications of ..... 198D July  
 Corona, measurement of ..... 172 Mar  
 Coupling, d-c, method of ..... 198D Apr  
 Counter, binary-decimal, 10 mc ..... 186 Nov  
 Counter circuits analyze ignition, Weller, Jr., Schubring & Fitch ..... 150 May  
 Counter, preset gating unit ..... 164 May  
 Counter, ring, transistor ..... 150 Sept  
 Counter, transistor forms flip-flop ..... 165 Sept  
 Counter, transistor, high-reliability, 171 June  
 Counter, transistor, light actuated, 212D Mar  
 Counter, used in chronograph ..... 152 Apr  
 Counters select magnetic drum sectors, Strassman & King ..... 161 Apr  
**CRO, see also cathode ray, oscilloscope, crt, tube**  
 CRO, gate moves in line drawings ..... 178 May  
 CRO, pulse attenuators for ..... 218D Aug  
**CRT, see also cathode-ray, oscilloscope, crt, tube**  
 CRT deflection circuit has high efficiency, Gugg ..... 172 Apr  
 Crystal clock for airborne computer, Pederson ..... 196D June  
 Crystal, three oscillator designs standardize circuitry ..... 177 Aug  
 Crystals, silicon, growing ..... 164 Feb  
 C-W, phase selector chooses ..... 202D May

**D**

DART, telemeters weather data ..... 196D Sept  
 Data transmitters speed ticket reservations ..... 192D Apr  
 D-C transformer ..... 224D May  
 Decoupling between microwave antennas, Harris ..... 204D June  
 Defense inventions ..... 193D Jan  
 Deflection, crt, high efficiency ..... 172 Apr  
 Deflection, magnetic, 21-inch scope ..... 159 July  
 Delay, computer unit ..... 173 July  
 Delay-line audio ..... 200D May  
 Delay lines, miniaturization of electronic equipment—special report ..... 187 Oct  
 Delay, torsional wave delay lines ..... 212D July  
 Deluxe auto transistor receiver ..... 192D Sept  
 Demodulator-limiter for control system signals, Johanson ..... 155 Sept  
 Demonstration neon multivibrator, Orr ..... 198D June  
 Design, amplifier, selectivity curves ..... 188 Aug  
 Design and manufacture of practical filter circuits, Boyle ..... 154 Dec  
 Design, cascade auto preamplifier, 234D Oct  
 Design, charts simplify passive d-c filter design ..... 160 Dec  
 Design, coaxial impedance chart ..... 190 Nov  
 Design, coaxial stub ..... 188 July  
 Design, Colpitts crystal oscillator ..... 146 Jan  
 Design, diode-clamp nomograph ..... 184 Sept  
 Design, ferro-amplifier ..... 150 Aug  
 Design, grounded-grid operation ..... 230D Aug



Design, helical scan nomograph...186 July  
 Design, high-power amplifier...170 July  
 Design, high-temperature subassembly...158 May  
 Design, L-network...186 Feb  
 Design, magnetic amplifier...156 Aug  
 Design, matching crystal pickups...181 May  
 Design, miniaturization of electronic equipment—special report...177 Oct  
**Design of the month**  
 Ceramic vacuum relay...216D Dec  
 Connector...230D Apr  
 Missile-locating beacon...228D May  
 Noise tube...242D Aug  
 Self-locking connector...251D Oct  
 Socket for ceramic triode...226D Sept  
 Solder feed...224D June  
 Stepper switch...254D Mar  
 Strain cells...236D Nov  
 Transducer...226D July  
 Design, oscillator, standard...177 Aug  
 Design, parallel-T nomograph...192 Nov  
 Design, radiation effects...250D Oct  
 Design, receiver, transistor...148 Apr  
 Design, transistor transformer nomographs...204 Mar  
 Design, transistorized lab relay...169 Aug  
 Design, waveguide loss charts...210 Oct  
 Designing airborne equipment for vibration, Mercurio, Jr. & Belby...166 Jan  
 Designing electronics to resist nuclear energy, Morgan...155 May  
 Designing oscillators for greater stability, Witt, Jr...180 Nov  
 Detector, buried cables...156 Sept  
 Designing tapered waveguide transistors, Migliaro...183 Nov  
 Detector, ducts and pipes...172 Jan  
 Detector, high sensitivity...184 Feb  
 Detector, infrared, diagnosis...155 Oct  
 Detector, intercarrier, alarm...188 Mar  
 Detector, noise level...168 Sept  
 Detector, phase, transistor...196D July  
 Detector, solar-flare, for IGY...162 Mar  
 Detector, DEW astenna alarm...216D Oct  
 Determining grounded-grid operation, Agresti...230D Aug  
 DEW antenna alarm...216D Oct  
 Dictating machine...206D May  
 Dielectric recorder uses simple pickup...200D Nov  
 Digital-analog converter provides storage, Putschl, Raper & Suran...148 Dec  
**Digital Computer, see also computer**  
 Digital computer, airborne...173 July  
 Digital computer, ERNIE...138 July  
 Digital data processing, counters select magnetic drum sectors...161 Apr  
 Digital printer boosts readout time, Gettings...182 June  
 Diode-clamp nomograph, Myers...188 Sept  
 Diode, silicon, chopper stabilizes...178 Jan  
 Diodes, silicon, logarithmic...196D Aug  
 Diodes, silicon, protect meters...224D Oct  
 Discriminator, speech-music...183 Apr  
 Display, back window...202D Nov  
 Distortion, indicator, uhf...180 Sept  
 Distributed amplifiers as antenna multicouplers, Pfund, Jr...176 Apr  
 Double sideband, a-m, aircraft...194D Apr  
 Double sideband, transmission, telephone, rural carrier system uses...146 Aug  
 Driving simulator shows crash hazards, Schwartz...192D June  
 Drone, for testing missiles...182 Mar  
 Drum, magnetic, sector...161 Apr  
 Dual-purpose circuitry cuts transceiver size, Wulfsberg & Kirkpatrick...134 Dec  
 Dual-triode tester measures tube balance, Yves...194 Mar

**E**

Effects of radiation...244D Mar  
 Egg candler...218D Jan  
**Electrocardiograph, see also medical electronics**  
 Electromechanical components, miniaturization of electronic equipment—special report...193 Oct  
 Electronic crowbar protects transmitter, Wenner...175 June  
 Electronic equipment, miniaturization of, special report...177 Oct  
 Electronic organ uses shared oscillators, George & Cutler...167 May  
 Electronic shutter for tv kinescope recorder, Crocker...186 May  
 Electronics controls gas chromatography, Donner...164 Nov  
 Electron Tube, see also tube  
 Electro-optical amplifier...210D Aug  
 Electrostatic generator has high stability, Gignoux...192D July  
 Electrostyl writer...206D June  
 Emission, grid, tester checks for...238D Mar  
 Emission, secondary, heaterless tubes use...190D Jan  
 Enclosure, shielded, for testing aircraft and missiles...236D Aug  
 Engineers work in altitude simulator...180D Dec  
 Engines, automobile, balancing of...205D Nov  
 Engines, circuits analyze ignition...150 May  
 English independent tv takes air...196D Apr  
 Equipment, electronic, miniaturization of, special report...177 Oct  
 ERNIE, computer selects winners...138 July

Errors, attenuator...216D June  
 Exact calibration from a standard, Simonsen...194D Sept  
 Experimental microwave...224D Jan  
 Extend output with regulated flip-flop, Hofheimer...182D Dec

**F**

Failure indicators...192D Jan  
 Ferrator, magnetic amplifier...156 Aug  
 Ferrite-core, binaries, ERNIE...138 July  
 Ferrite-rod antennas operate in X-band, Reggia, Spencer, Hatcher & Tompkins...159 Jan  
 Ferrites, lossy transmission line...204D Apr  
 Field direction oscillator, Lewis & Rader...208D Feb  
**Field Strength, see also propagation**  
 Film reader measures recorded radar echoes, Shapiro...154 Jan  
 Filters, design and manufacture of practical filter circuits...154 Dec  
 Flat-field generator speeds color tv testing, Cook...139 Dec  
 Flattening response of crystal pickups, Cleland...181 May  
 Flat tube suitable for color tv...190D Feb  
 Flight simulator tests fire-control radars, DeMyer...168 June  
 Flip-flop, unijunction transistor...165 Sept  
 Fluid-cooling an airborne transmitter, Humfeld...170 July  
 Flush-mount antenna...202D May  
 F-M, automatic data plotter...182 Aug  
 F-M, Coneblad control...190D Jan  
 F-M, microwave traffic control...143 July  
 F-M, ultrasonic propagation test...152 Jan  
 F-M voltage-tuned magnetron...182 May  
 Focusing oscilloscope cameras, Nail...192D Sept  
 Fork-driven dual tone standard, Kretzman...196D Feb  
 Forty-meter transistor transmitter...190D Feb  
 Frequency, calibration...194D Sept  
**Frequency Modulation, see also f-m, broadcast, etc.**  
 Frequency, monitoring, mobile FCC...152 Oct  
 Frequency standard, portable transistor...194D June  
 Fuel injection triggered by engine needs...192D Feb  
 Fuses, avoiding blown...218D Nov

**G**

Gage, strain, system for aircraft telemetering...170 Oct  
 Galactic noise affects tv receivers...198D Aug  
 Gamma-ray monitor has high reliability, Jackson & Suran...170 Nov  
**Gas discharge tube, see also tube**  
 Gate, tristable, cro...178 May  
 Gate tube generates interleaved pulse chain, Kushner...186 Apr  
 Gating, noise tube, for age and sync...172 May  
**Generator, signal, see also type, audio, pulse, video, sweep, etc. and oscillator**  
 Generator, comic face cro...178 May  
 Generator, electrostatic...192D July  
 Generator, gate tube...186 Apr  
 Generator, phase, resistive shifter...175 Nov  
 Generator, pulse, uses transistors...176 Sept  
 Generator, sweep, transistor...202D Aug  
 Generator, sync, for tv...170 Aug  
 Generator, sync, itv systems...174 Aug  
 Generator, tone organ...167 May  
 Generator, transistor, pulse...180 Jan  
 Generator, ultrasonic, brewery...162 July  
 Generator, vhf, vlf oscillator keys...184 May  
 Generators, synchronization, tv...168 July  
 Generators, voltage-controlled pulse, used in voltage regulators...184 Sept  
**Germanium, see also transistor**  
 Graphic construction finds clear i-f, Hargreaves, Jr...170 Dec  
 Grid-operated thyratron, Boyarsky...214D Mar  
 Ground-controlled drone tests missiles, Warren & Corden...182 Mar  
 Grounded-grid operation...230D Aug  
 Guidance, Nike-Hercules...208D Feb  
 Guided missile, beacon for...144 Apr  
 Guided missile, long-range, atmospheric effects on propagation...208D Mar  
 Gun, color crt, low voltage...204D Nov

**H**

Heater surge chart, Feyerherm...188 June  
 Heaters, induction, thyratron...152 July  
 Heaterless tubes use secondary emission...190D Jan

Helical scan nomograph, Wood...186 July  
**High Fidelity, see also audio**  
 High-frequency circuits use meitback tetrodes, Baker...177 June  
 High-reliability transistorized counter, Chisholm...171 June  
 High-speed computer stores 2.5 megabits, Papiian...162 Oct  
 High-speed strobe checks tube vibrations, Leib & Ritchey...224D Feb  
 High-temperature subassembly design, Kiebertz...158 May  
 Horsepower nomograph for radar antenna rotators, Peay...188 Jan  
 How to design Colpitts crystal oscillators, Gruen...146 Jan  
 How transistors operate under atomic radiation, Riddle...125 Dec  
 Hybrid parameters, formulas...188 Apr

**I**

Ice, antenna alarm DEW line...216D Oct  
 Ignition, rectifier for locomotives...220D Mar  
 Impedance, coaxial line, chart...190 Nov  
 Indicator, distortion, used for tuning uhf transmitter...180 Sept  
 Indicator, for motor speeds...188 May  
 Indicator, meter, protected by silicon diodes...224D Oct  
 Indicator, radar range, uses phase shift oscillator...160 Oct  
 Indicator, rate-of-climb, uses doppler radar...150 June  
 Indicator simplifies color tv tuning, Goldberg...194D Nov  
 Indicators, failure, for broadcast interlock circuits...192D Jan  
 Induction, audio paging system...178 Feb  
 Inexpensive oven thermostat, Crane...225D Oct  
 Infrared camera...184D Dec  
 Infrared, measures range...190D July  
 Infrared detector aids medical diagnosis, Osborne...155 Oct  
 Infrared, r-f supply for viewers...163 Nov  
 Instantaneous speech compressor, Rutherford...168 Feb  
 Instrument aircraft, rate-of-climb meter...150 June  
 Instrument, compliance meter tests phono cartridges...206 Oct  
 Instrument, flight simulator, tests fire-control radars...163 June  
 Instrument, measuring parameters of junction transistors...174 Aug  
 Instrument, temperature control, for gas chromatography...164 Nov  
 Instrument, test equipment for transistor production check...148 Oct  
 Instrument, transistor beta tester...212D Aug  
 Insulation, capacitor, resistance of...214D July  
 Integrating circuit for direct recorder, Gilson & Andrea...216D Feb  
 Intercarrier failure rings alarm, Atwood...188 Mar  
 Interelectrode capacitance tester, Martin & Meth...220D Apr  
 Interference, radio, caused by solar-flare...162 Mar  
 Interlace, dot, sync generator for color tv...170 Aug  
 Inventions, defense...198D Jan  
 Inverter, transistor, used to power Vanguard rocket...203D Apr  
**Ionosphere, see also propagation**  
 Ionosphere artificial...194D July  
 Iron dust magnet...250D Mar  
 Irradiated polyethylene...246D Mar  
 Isolation, tv receivers...148 July

**J**

Jacks, panel, miniaturization of electronic equipment—special report...195 Oct  
 Jukebox and tape automatic radio shows, Birch...156 Nov  
 Junction transistor, see also transistor

**K**

Kinescope, tv, recorder, electronic shutter for...186 May  
 Klystron, see also tube



L-network design, Mathis, 186 May  
 Large shielded enclosure, Costello & McMichael, 236D Aug  
 Launching intercommunicator, 196D Apr  
 Legal medium, 226D Jan  
 Level indicator uses x-rays, 196D Jan  
 Light actuated counter grant, 212D Mar  
 Light, direction measurement of, 165 July  
 Light, radio, 212D May  
 Limiter, demodulator, 155 Sept  
 Lines, delay, torsional wave, 212D July  
 Link, air-ground data, 194D May  
 Link, White Alice, Alaska, 192D Jan  
 Links, scatter circuits, 200D May  
 Logarithmic amplifier has 50-db range, Kohl, 214D Jan  
 Logarithmic amplifier measures noise, Wells, 169 Apr  
 Logarithmic amplifier, measuring corona by means of a, 172 Mar  
 Long scope probes using passive elements, Santelmann & Hingston, 206D Sept  
 Lossy transmission line filter uses ferrites, Shive, 204D Apr  
 Low-mu triodes control power, Dagelman, 204D Aug  
 Low-power drives p-a, Dlugatch, 214D May  
 Low temperature effects, 196D Apr  
 Low transit time semiconductor amplifier, 190D Sept  
 Low-voltage color-tube gun, 204D Nov  
 Luminous panels, 202D Feb



**Machining Techniques**  
 Cutting sponge rubber into long strips with pinking machine, 252D Oct  
 Drilling fixture, 254D Apr  
 Drilling holes in servo housings three-at-a-time, 226D May  
 Grinding servo stators, 216D May  
 Set screws speed centering of punch, 280D Oct  
 Ultrasonic machining of ceramic spacers for vacuum tubes, 254D Oct  
 Waveguide bender uses clockspring-steel mandrel, Palmisano, 226D May  
 Magic tee technique refine load matching, Macpherson, 230D Nov  
 Magnetic components, miniaturization of electronic equipment—special report, 191 Oct  
 Magnetic computer has high speed, Bonn, 156 Aug  
 Magnetic core coincidence circuit, Freedman, 194D Aug  
 Magnetic drum, counters select sectors of, 161 Apr  
 Magnetic field pickup follows buried cables, Webster & Carroll, 156 Sept  
 Magnetic-optical sound recording, 192D Aug  
 Magnetic, radiation effects on magnetic materials, 250D Oct  
 Magnetite tape, see also recorder, recording, tape recording  
 Magnetic tape controls projector synchronism, Whitaker, 143 Sept  
 Magnetically deflected 21-inch oscilloscope, O'Kelley & Todd, 159 July  
 Magnetron, see also tube  
 Magnetron, voltage-tuned, f-m, 162 May  
 Manometer, movable-anode tube, 232D Mar  
 Matching, load, magic tee, 230D Nov  
 Materials, magnetic, radiation effects on, 250D Oct  
 Materials, miniaturization of electronic equipment—special report, 185 Oct  
 Measurement, see also meter, instrument, test equipment  
 Measurement, atmospheric noise, 208 Oct  
 Measurement, attenuator errors, 216D June  
 Measurement, buoy telemeters ocean temperature data, 164 June  
 Measurement, capacitors, 177 July  
 Measurement, decoupling between microwave antennas, 204D June  
 Measurement, frequency, for FCC, 152 Oct  
 Measurement, heartbeat, 161 Aug  
 Measurement, height and temperature of oil in refinery tanks, by computer, 143 Oct  
 Measurement, interelectrode capacitance by means of tester, 220D Apr  
 Measurement, light direction, 165 July  
 Measurement, minority-carrier life in semiconductor materials, 145 Aug  
 Measurement, neutron flux density, 246D Oct  
 Measurement, ocean temperature, 142 May  
 Measurement, of elastic moduli, 214D Sept  
 Measurement, of noise by means of logarithmic amplifier, 169 Apr  
 Measurement, of transistor beta, 212D Aug  
 Measurement, parametric, transistor, 148 Oct  
 Measurement, preset kating unit, 164 May  
 Measurement, range, infrared, 190D July  
 Measurement, rocket telemeters weather data, 196D Sept  
 Measurement, simultaneous color tv test signal, 146 May

Measurement, stroboscope measures shaft torque, 147 June  
 Measurement, transistor beta, 212D May  
 Measurement, transistor symmetry, 200D Sept  
 Measurement, weather bureau telemetering system is balloon borne, 158 Sept  
 Measuring, see also measurement, meter instrument, test equipment  
 Measuring, analyzer measures attenuation characteristics of filter and other networks, 134 Mar  
 Measuring, blood pressure, 232D Mar  
 Measuring, capacitance pickup, 143 Feb  
 Measuring, clamp-on microammeter, measures a-c, 152 Dec  
 Measuring, corona from radioactive point, Hendrick, Jr., Martin & Chapman, 172 Mar  
 Measuring elastic moduli by ultrasonics, 214D Sept  
 Measuring parameters of junction transistors, Hendrick, 174 Aug  
 Measuring recorded radar echoes, 154 Jan  
 Measuring, reference generators for ssb systems, 152 Feb  
 Measuring, spot scanner counts micron-sized particles, 142 Dec  
 Measuring, spot weld current, by use of toroid, tube balance, 132 Dec  
 Measuring, tube balance, 194 Mar  
 Measuring, of sweep generator determines power-gain parameter of transistor, 201 Mar  
 Mechanized production of tv wiring boards, Markus, 138 Apr  
 Medical electronics, infrared detector aids diagnosis, 155 Oct  
 Medical electronics, tunes monitor heart's electrical action, 160 Nov  
 Megawatt broadcast beam triode, 216D Mar  
 Memory, see also storage  
 Memory, 2.5 megabits, 162 Oct  
 Memory, planes, three-dimensional printed wiring for, 160 June  
 Metal detector checks fabrics, 192D June  
 Metal detector finds ducts and pipes, Todd, 172 Jan  
 Meter, see also instrument, test equipment, measurement, measuring  
 Meter, clamp-on, microammeter measures a-c, 152 Dec  
 Meter, compliance, tests phono cart-ridges, 206 Oct  
 Meter, digital frequency, uses high-reliability counter, 171 June  
 Meter, mag. magnetic amplifier, 204D Jan  
 Meter, Far-ohm-ohm, 159 June  
 Meter shows current drift from nominal, Geiser, 192D Dec  
 Meters, protected by silicon diodes, 234D Oct  
 Microphone, ultrasonic, tv sets, 156 Mar  
 Microphones, miniaturization of electronic equipment—special report, 194 Oct  
 Micropotentiometer, 210D May  
 Microwave circuits, miniaturization of electronic equipment—special report, 180 Oct  
 Microwave, platinotron increases search radar range, 164 Aug  
 Microwave, printed circuit attenuator, 216D Mar  
 Microwave remotes aid air traffic control, Peterson, Ulander, Hargis & Hajic, 144 July  
 Miniature tv camera uses drift transistors, Flory, Gray, Morgan & Pike, 138 Jan  
 Miniaturization of electronic equipment—special report, Findlay, 177 Oct  
 Design, 178 Oct  
 Materials, 185 Oct  
 Cables & Connectors, 186 Oct  
 Circuit components, 188 Oct  
 Magnetic components, 191 Oct  
 Electromechanical components, 193 Oct  
 Panel components, 195 Oct  
 Power supplies, 196 Oct  
 Relays, 199 Oct  
 Tubes and transistors, 200 Oct  
 Production, 202 Oct  
 Missile, DART, used to gather weather data, 196D Sept  
 Missile, drone tests, 182 Mar  
 Missile, beacon antennas for, 166 Mar  
 Missile, submarine beacon for, 144 Apr  
 Missile, ship, stabilization, 138 June  
 Missile, target for tests, 141 Nov  
 Missile, telemeter uses transistor amplifier, Porter, 170 May  
 Missiles, strain gage system for, 170 Oct  
 Mixer, audio, transistor, 248D Oct  
 Mobile communications impulse signaling, Olson, 214D Feb  
 Mobile monitor covers tv stations for FCC, Day, 152 Oct  
 Mobile radar uses balloon antenna, 198D Nov  
 Models, ship, navigation trainer, 172 Sept  
 Modular, series gate, transmitter, 167 Nov  
 Modulation, broadcast monitor, 200D July  
 Modulation, chopper, corona, 172 Mar  
 Modulator, fuel injection control, 192D Feb  
 Moduli, elastic, ultrasonics, 214D Sept  
 Monitor, broadcast modulation, 200D July  
 Monitor, gamma-ray, 170 Nov  
 Monitor, mobile tv, 152 Oct  
 Monitor, muscles control, 180 July  
 Monitor, tower air, broadcast, 190D Jan  
 Monitor, tv studio, boost video, 205 Oct  
 Monitoring, heart's action, 160 Oct  
 Monochrome slides broadcast color, Covington, 169 Mar  
 Monovibrator has fast recovery time, Aronson & Chong, 158 Dec  
 Morse-to-teletypewriter code converter, Smith-Vaniz & Barrett, 154 July  
 Motion minimizes image orbicon burn-in, Wilner, 180 Aug

Motor, pen, rectilinear recording, 159 Feb  
 Movable-anode tube, 232D Mar  
 Multicoupler, antenna, amplifier, 176 Apr  
 Multiplex, antenna, system design, 148 July  
 Multiplexing, microwave remotes aid air traffic control, 144 July  
 Multiplexing, sound and video, 151 Jan  
 Multiplexing, transistorized radio-teletypewriter, 150 Sept  
 Multivibrator, neon demonstration, 198D June  
 Multivibrator, transistor, 184 Sept  
 Multivibrator, transistorized, sensory aid, 162 Feb  
 Multivibrator, unijunction, flip-flop, 165 Sept  
 Muscles, control iron-lung operation, Montgomery, 180 July  
 Music-pulse analyzer rejects voice signals, Ives, 183 Apr



Navigation, Vortac beacons for, 156 June  
 Navigation, trainer, controls ship models, Rich, 172 Sept  
 New radars speed traffic control, 196D Jan  
 Nike-Hercules guidance, 208D Feb  
 Noise, aircraft and missiles, 236D Aug  
 Noise, atmospheric, measurement, 208 Oct  
 Noise, galactic tv receivers, 198D Aug  
 Noise gating tube for agc and sync, Spracklen Stroh & Wood, 172 May  
 Noise, log amplifier measures, 169 Apr  
 Noise, receiver detects signal below noise level, 168 Sept  
 Nomograph, amplifier selectivity curves, 188 Aug  
 Nomograph, diode-clamp, 188 Sept  
 Nomograph, helical scan, 186 July  
 Nomograph, horsepower for radar antenna rotators, 188 Jan  
 Nomograph, parallel-T, 192 Nov  
 Nomograph, reflection point and angle for propagation, 184 Jan  
 Nomograph, transistor transformer design, 204 Mar  
 Nuclear, designing electronic equipment to resist radiation, 165 May  
 Nuclear, transistor reactor control, 246D Oct  
 Null detector, transistor, 184 Feb



Oil measurement, height and temperature, 143 Oct  
 One-day memory, 210D Feb  
 Operational bridge gages high capacitance, Konigsberg, 175 Jan  
 Optical, electronic, amplifier, 210D Aug  
 Organ, electronic, shared oscillators, 167 May  
 Oscillator, Colpitts crystal, design, 146 Jan  
 Oscillator, crystal, stable, 216D Sept  
 Oscillator, design, stability, 180 Nov  
 Oscillator, field direction, 208D Feb  
 Oscillator, increases radar range, 164 Aug  
 Oscillator, phase shift, radar range, 160 Oct  
 Oscillator, standard design, 177 Aug  
 Oscillator, transistor, tuned, 218D Feb  
 Oscillator, tuning, fork-driven, 196D Feb  
 Oscillator, ultrasonic, tracking fish, 156 Apr  
 Oscillator, vhf, keys vhf generator, 184 May  
 Oscillator, wobble, tv, 194D Aug  
 Oscillators, crystal, transistor, 218D Oct  
 Oscillators, electronic organ, 167 May  
 Oscillators, 400 ke and 1.6 mc chronograph, 152 Apr  
 Oscillators, high-power, to heat tube elements, 152 July  
 Oscillograph, see also recorder-pen  
 Oscillograph analyzes cutter, 204D Jan  
 Oscillograph, pen motor for rectilinear recording, 159 Feb  
 Oscilloscope amplifier, 202D Jan  
 Oscilloscope, camera, focusing of, 192D Sept  
 Oscilloscope, display, attenuators, 218D Aug  
 Oscilloscope, probe for, 206D Sept  
 Oscilloscope, 21-inch, magnetically-deflected, 159 July  
 Over-horizon propagation, see also propagation



Pads, see also attenuators  
 Paging system, audio induction, 178 Feb  
 Packages, circuit, miniaturization of electronic equipment—special report, 203 Oct  
 Packages, power supply, miniaturization of electronic equipment—special report, 198 Oct

Panel components, miniaturization of electronic equipment—special report 195 Oct

Parallel-T nomograph, Carter 192 Nov

Parameters, measurement of, in junction transistors 174 Aug

Parameters, hybrid, conversion formulas for 188 Apr

Patents, pertinent 216D July

Patents, pertinent 216D Sept

Pen motor for rectilinear recording, Massa & Massa 159 Feb

Pen recorder resolution increase, D amantides 210D Nov

Perfect metals 218D Apr

Pertinent patents, Chalfin 216D July

Pertinent patents, Chalfin 216D Sept

Phase, c-w, selector chooses 202D May

Phase generator has resistive shifter, Phil 175 Nov

Phase-shift oscillator indicates radar range, Barritt 160 Oct

Phono, meter tests cartridges 206 Oct

Phonograph, preamp 200D Aug

Phonograph, transistor, preamp 204D May

Photocell measures light direction, Walsh 165 July

Photocell, auto mirror 196D July

Photocell, lights and marks 162 Feb

Photoelectric target for missile tests, Dorsey 141 Nov

Photograph, projector synchronism 143 Sept

Photography, video recorder 146 Sept

Photography, video scanner 154 Aug

Phototube checks razor blades in production 190D June

Phototubes count buses 188D Dec

Pickup, crystal, response of 181 May

Pickup, magnetic field, follows buried cables 156 Sept

Pickup, phono, ceramic, preamp 200D Aug

Pickup, dielectric recorder 200D Nov

Planes land no-hands on carrier deck 194D Apr

Plant observed by itv 210D July

Plastic envelope, work orders 268D Nov

Platinotron increases search radar range, Brown 164 Aug

Plotter, f-m/f-m, telemetering 182 Aug

Plugs, panel, miniaturization of electronic equipment—special report 195 Oct

Polygraph, integrating circuit for 216D Feb

Portable tv station for remote pickups, Flory, Gray, Morgan & Pike 170 Feb

Portable transistor frequency standard, Deyer 194D June

Power amplifier for servo testing, Diamond 176 May

Power control, triodes 204D Aug

Power, in tv receiver, reduced 172 Apr

Power, luminous, radio waves 212D May

Power, r-f amplifier 214D May

Power Supply, compact supplies have wide-range regulation 168 Dec

Power supply, design of 203D Apr

Power supply, r-f, infrared 163 Nov

Power supplies, miniaturization of electronic equipment—special reports 196 Oct

**Printed Circuit Techniques**

Blank cards serve as printed circuit breadboards, Lindgreen & Osborn 234D Nov

Drilling pantograph 242D Jan

Electronic printer for etched slot antennas, Isaacson & Hoffman 238D July

Localized plating of etched wiring 236D Feb

Molded flush wiring for printed circuits, Bell 266D Oct

New materials cut drafting costs for printed circuits, Shuster 252D Mar

Phototube-controlled drilling machine for printed-wiring boards 230D Jan

Printer eliminates drying of resist on printed wiring boards 226D Sept

Quick-change drills for printed-circuit boards 226D July

Sealless plastic pumps feed acid to wiring-board etcher 228D Apr

Transparent polyethylene bags protect printed circuits 214D Dec

Universal etched circuit for plug-in units, Wise & Bequaert 230D June

Wiring board press uses tape control 236D Jan

Probability computer for noise measurement, Sullivan & Wells 208 Oct

Probe, scope, passive 206D Sept

Production, core tester 150 Aug

Production, miniaturization of electronic equipment—special report 202 Oct

Production, 3-D printed wiring 160 June

Production titles 278D Oct

Profile cutter makes multiple copies 204D Feb

Programming, small a-m stations 146 Feb

Projector, synchronization of 143 Sept

Propagation, anomalous 224D Apr

Propagation, atmospheric effects 208D Mar

Propagation, nomograph, reflection point and angle 184 Jan

Propagation, problems solved in using radiophone to speed aircraft communications 164 Apr

Propagation, ridge vane antenna provides constant beamwidth 196D Nov

Propagation, scatter circuits 200D May

Propagation, ultrasonic f-m tests 143 Jan

Preamplifier, cascade auto 234D Oct

Preamplifier for ceramic pickups, Newitt 200D Aug

Preamplifier, see also amplifier

Preamplifier, transistor, phono 204D May

Precise heat for growing silicon crystals, Davis, Alden and Wyeth 164 Feb

Precision spotwelder handles metal foils, Robinson 150 Feb

Preset gating unit for aeroballistic testing, Dorsey 164 May

Printed circuit microwave attenuator, Fallon 216D Mar

Printed circuits, miniaturization of electronic equipment—special report 179 Oct

Printer, digital, boosts readout 182 June

Pulse analyzer, music, for rejection of voice signals 183 Apr

Pulse attenuators for cro displays, McFarlane 218D Aug

Pulse chain, interleaved 186 Apr

**Pulse generator, see also generator**

Pulse generator, uses junction transistors, Fuller 176 Sept

Pulse voltage regulator, uses multivibrators 184 Sept

Pulse width, automatic control 200D Apr

Pulsed f-m tests ultrasonic propagation, Unterberger 143 Jan

Pulsed light tests minority-carrier life, Armstrong 145 Aug

Puncher transcribes computer output, Palmer & Propster, Jr. 164 Dec

Rush-pull transistor radio 190D July

**R**

Radar, DEW, antenna alarm 216D Oct

Radar, artificial ionosphere 194D July

Radar, doppler, rate-of-climb meter 150 June

Radar echoes, measurement 154 Jan

Radar, flight simulators 168 June

Radar, horsepower nomograph for antenna rotators 185 Jan

Radar, microwave remotes aid air traffic control 144 July

Radar, mobile, balloon antenna 198D Nov

Radar, platinotron increases range 164 Aug

Radar, phase-shift oscillator 160 Oct

Radar speeds air traffic control 196D Jan

Radar telemetering trains pilots 194D Nov

Radar, video recorder 146 Sept

**Radiation, see also propagation**

Radiation effects on magnetic materials 250D Oct

Radiation, nuclear, designing electronic equipment to resist 155 May

Radiation, reactor, effects of an electronic components 244D May

Radiation whiskers 244D Mar

Radiator, sleeve, tv 208D Mar

**Radio, see also communications, broadcast, transmitter, receiver**

Radio, announcements selected 158 Oct

Radio astronomy, integrating receiver detects signals below noise level 168 Sept

Radio, changeover of transmitters 138 Sept

Radio, automobile, transistor 192D Sept

Radio-controlled toys use spark gap 190D Sept

Radio, jukebox and tape shows 156 Nov

Radio light 212D May

Radio link uses meteor trails 192D Aug

Radio printer for air commands 194D May

Radio replaces German railway semaphores 194D Jan

Radio, teletypewriter, multiplex 150 Sept

Radio, transistor, push-pull 190D July

Radio transmitter for ionospheric scatter, Hollis, Collins & Schmidt 144 June

Radiophone, aircraft, speeds communications 164 Apr

Radiotelephone, single sideband links Canadian traders 174 Oct

Random numbers 228D Jan

Range, infrared measures 190D July

Range, radar, indicator 160 Oct

Range, radar, increase of 164 Aug

Rapid missile tester 242D Mar

Rate-of-climb meter uses doppler radar, Logue 150 June

Reactor, control, transistor 246D Oct

Reactor, nuclear, designing electronic equipment to be used with 155 May

Reader, film, measuring radar echoes 154 Jan

Readout, time of, boosted 182 June

**Receiver, see also f-m, a-m, television**

Receiver, a-m, pulse analyzer rejects voice signals 183 Apr

Receiver, tv, galactic noise 198D Aug

Receiver, tv, mechanized production of wiring boards for 138 Apr

Receiver, cordless audio device 200D Jan

Receiver, detector, used to indicate interference failure 188 Mar

Receiver detects signals below noise level, Blair 168 Sept

Receiver, 500-ke pickup, for ship alarm uses computer techniques 180 Feb

Receiver, radio, connected to electric clock time-setter 174 July

Receiver, radio, design simplification by use of tetrajunction transistor 148 Apr

Receiver, radiotelephone, used in aircraft communications 164 Apr

Receiver, remote control 155 Mar

Receiver, remote control 149 Feb

Receiver, single sideband links Canadian traders 174 Oct

Receiver, transistor, automobile 192D Sept

Receiver, transistor, push-pull 190D July

Receivers, communications, calibration method 194D Sept

Receivers, multicouple use, by means of distributed amplifiers 176 Apr

Receivers, television, antenna-multiplex system design for 148 July

Reception, multicoupling of receiver antenna by means of distributed amplifier 176 Apr

Reception, tv, sleeve radiator 205D Mar

**Recorder, see also recording, measuring, telemetering**

Recorder, blood-pressure 232D Mar

Recorder, dielectric, fuses simple pickup 200D Nov

Recorder, integrating circuit 216D Feb

Recorder, medical, transistor amplifier used in 161 Aug

Recorder, resolution increase 210D Nov

Recorder, tape, radio announcements 158 Oct

Recorder, tv kinescope shutter 186 May

Recorder, video, uses revolving heads 138 Aug

Recorder, video, radar observers 146 Sept

Recording, magnetic-optical sound 192D Aug

Recording, rectilinear, open motor 159 Feb

Recording, telemetering weather 158 Sept

Recording, transistor mixer 248D Oct

Rectangular dark-trace tube, Rottgardt & Heller 208D June

Rectifier locomotive, Wallace & Zehner 220D Mar

Rectifiers miniaturization of electronic equipment—special report 197, 200 Oct

Reference generator for ssb systems, Jacob 152 Feb

Reference sheet, amplifier selectivity curves 188 Aug

Reference sheet, coaxial line impedance chart 190 Nov

Reference sheet, coaxial stub design 188 July

Reference sheet, conversion formulas for hybrid parameters 188 Apr

Reference sheet, diode-clamp nomograph 188 Sept

Reference sheet, heater surge chart 188 June

Reference sheet, helical scan nomograph 186 July

Reference sheet, horsepower nomograph for radar antenna rotators 188 Jan

Reference sheet, L-network design 186 Feb

Reference sheet, parallel-T nomograph 192 Nov

Reference sheet, reflection point and angle nomograph 184 Jan

Reference sheet, servo analysis chart 173 Dec

Reference sheet, temperature conversion chart 192 May

Reference sheet, transistor transformer design nomographs 204 Mar

Reference sheet, transmission line impedance measurement 186 June

Reference sheet, waveguide loss charts 210 Oct

Reflection point and angle nomographs, Prihar 184 Jan

Reflection, radio, meteor trails 192D Aug

**Reflector, see also antenna**

Reflex transistor radio 192D Aug

Regulator, voltage, multivibrator 184 Sept

Relay, lab, transistorized 169 Aug

Relays, miniaturization of electronic equipment—special report 199 Oct

Relays, transistor, have low idling current 147 Dec

**Remote control, see also telemetering, radio, receivers, ultrasonics**

Remote control receiver, Bohr 149 Feb

Remote visual control of proton beam 194D Jan

Resistance, capacitor insulation 214D July

Respirator, low- $\mu$  triode tubes 204D Aug

Response, crystal pickups 181 May

R-F power supply for infrared viewers, Fujji & Kojima 163 Nov

Ridge vane antenna provides constant beamwidth, Scanga 196D Nov

Rocket telemeters weather data 196D Sept

Rural carrier system uses transistors.

**S**

S-Stachiewicz 146 Aug

S-band array antenna for missiles 166 Mar

SADAP, f-m/f-m telemetering 182 Aug

Satellite equipment being assembled 190D Feb

**Saturable Reactor, see also reactor, amplifiers—magnetic**

Scale, speed indicator, expanded 188 May

Scan, radar helical, nomograph 186 July

Scanner, flying-spot, color tv system uses 138 Feb

Scanner, video, matches photo patterns 154 Aug

Scatter circuits 200D May

Scatter ionosphere transmitter 144 June

Searchlight, airborne, electronic 190D June

Selective a-f induction signaling, Philipps 180 June

Selectivity, amplifier, curves for 188 Aug

Selector chooses c-w phase, Belheld 202D May

Selector, counter, magnetic drum 161 Apr

Self-deflecting auto rear mirror 196D July

Semiconducting compounds, Coblenz	144 Nov	Sound, electronic organ, uses oscillators	167 May	Television, color, low voltage crt gun	204D Nov
Semiconductor, see also diode, transistor		Sound, equipment used in air-drop system to broadcast messages	179 Mar	Television, color, monochrome slides broadcast color	169 Mar
Semiconductor, amplifier, low transit time	190D Sept	Sound, gong controls tv sets	156 Mar	Television, color, sync generator	170 Aug
Semiconductor, flip-flop	165 Sept	Sound, heart beat measured by pen recorder	161 Aug	Television, color system uses flying-spot scan	138 Feb
Semiconductor, pulse generator	176 Sept	Sound, magnetic-optical recording	192D Aug	Television, color, test signal for	146 May
Semiconductors, computer delay	173 July	Spacistor, low transit time semiconductor amplifier	190D Sept	Television, Conelrad control	190D Jan
Semiconductors, minority-carrier life	145 Aug	Spark gap, radio-controlled toys	190D Sept	Television, electronic shutter for tv kinescope recorder	186 May
Semiconductors, used in equipment to production-test transistors	148 Oct	Speaker, h-f transducer tweeter	192D Apr	Television expands teaching staff	192D Feb
Sensory aid defines lights and marks, Hurtig	162 Feb	Special report, miniaturization of electronic equipment	177 Oct	Television, flat field generator speeds color tv testing	139 Dec
Servo analysis chart, Biser and Adler	173 Dec	Speed indicator has expanded scale	188	Television, flat tube for color tv	190D Feb
Servo, hydraulic, speed indicator	188 May	Spot scanner counts micron-sized particles, Mansberg, Yamagami & Berkley	142 Dec	Television, industrial, plant observed by	210D July
Servo system, navigation trainer	172 Sept	Spot wobble cuts tv screen lines	194D Aug	Television, industrial, slow-scan adapter for conventional tv signals	153 June
Servo system, stabilization of missile ships	138 June	Sputnik's beep baffles scientists	178D Dec	Television, industrial, sync circuits time tv systems	174 Mar
Servo, testing, power amplifier for	176 May	Squelch, mobile impulse signal	214D Feb	Television, intercarrier failure rings alarm	188 Mar
Setter, electronic time, used to set electric clock	174 July	SSB, see also single-sideband		Television, mechanized production of tv wiring boards for receivers	138 Apr
Shifter, resistive, in phase generator	175 Nov	Stability, oscillator, design of	180 Nov	Television, miniature itv camera uses drift transistors	138 Jan
Ship autalarm uses computer techniques, Sarratt	180 Feb	Stability, phase, color tv	170 Aug	Television, monitor, FCC	152 Oct
Ship radar	226D Apr	Stability, temperature	218D Oct	Television, motion minimizes image orthicon burn-in	180 Aug
Shows, radio, jukebox and tape	156 Nov	Stabilization, induction heater	152 July	Television, portable station for remote pickups	170 Feb
Shutter, electronic, for tv kinescope recorder	186 May	Stabilization, missile ships	138 June	Television, receiver, crt deflection circuit has high efficiency	172 Apr
Signal generator, see also generator, oscillator		Stabilizing d-c amplifier	178 Jan	Television, receiver, antenna-multiplex system design	148 July
Signal generator, vhf, keying of	184 May	Standard calls	224D May	Television, receiver, high-frequency circuits use meltback tetrodes	177 June
Signal, slow-scan, adapter for conventional tv signals	153 June	Starting point	220D May	Television, receiver, noise gating tube for agc and sync	172 May
Signal, time, broadcast sets electric clock	174 July	Storage, see also memory		Television, sleeve radiator	208D Mar
Signaling, selective a-f induction	180 June	Storage, digital-analog converter provides	148 Dec	Television, transistors boost video for tv studio monitors	205 Oct
Signals, control system, demodulation limiter for	155 Sept	Storage, 2.5 megabits	162 Oct	Television, transistors synchronize portable tv camera	168 July
Signals, detector, below noise level	168 Sept	Storage, video data	146 Sept	Television, ultrasonic gong controls tv sets	156 Mar
Signals, voice rejection of	153 Apr	Strain gage system for aircraft telemetering, Brooks & Stephenson	170 Oct	Television, video tape recorder uses revolving heads	138 Aug
Silicon diode chopper stabilizes d-c amplifier, Fleming	178 Jan	Stroboscope, high speed	224D Feb	Temperature, body, response of by infrared detector for diagnosis	155 Oct
Silicon diodes as logarithmic elements, Golahny	196D Aug	Stroboscope, transistorized	147 June	Temperature, compensation of silicon transistor amplifiers	184 July
Silicon diodes protect meters, Smith	224D Oct	Stub, coaxial, design of	188 July	Temperature compensation, transistor amplifiers, by means of thermistors	169 Jan
Silicon transistor, see also transistor		Subminiature beacon for guided missiles, Cohen & Arany	144 Apr	Temperature conversion chart	192 May
Silicon transistor crystal oscillators have high temperature stability, Homer	218D Oct	Superregenerative transistor receiver, Chow	180 Apr	Temperature, high, subassembly design	158 May
Simple sync circuits time tv systems, Manogian	174 Mar	Supersonic, see also ultrasonic, sonic supply aids coupling	198D Apr	Temperature, low, effects of on electronic components	196D Apr
Simple transistor sweep generator, Armstrong	202D Aug	Supply, electrostatic generator	192D July	Temperature, measurement of oil in refinery tanks by computer	143 Oct
Simulating computer	206D Apr	Supply, power, design of using transistors for inverter	203D Apr	Temperature, ocean, buoy telemeters data of	164 June
Simulator, automobile driving, shows crash hazards	192D	Supply, power, wide-swing choke	202D July	Temperature, ocean measurement	142 May
Simulator, flight, radar	168 June	Supplies, power, miniaturization of electronic equipment—special report	196 Oct	Temperature, over thermostat	222D Oct
Simultaneous color-tv test signal, Kennedy	146 May	Suppression, voice signal	183 Apr	Temperature, stability, oscillator	218D Oct
Single-carrier system for sound and video, Wolfe	151 Jan	Sweep generator, transistor	202D Aug	Test and pumping equipment for microwave tubes	194D Feb
Single Sideband, see also ssb		Sweep testing thyratron characteristics, Weissman	206D Dec	Test equipment, see also meter, instrument measurement	
Single sideband, aircraft communications, studied for use	194D Apr	Sweep, triangular search	178 Nov	Test equipment, chronograph, for timing supersonic models in wind tunnel tests	152 Apr
Single sideband links Canadian traders, Horner, Crosby & Coffman	174 Oct	Sweeper determines power-gain parameter, Coffey	201 Mar	Test equipment, compliance meter tests phono cartridges	206 Oct
Single sideband, reference generator	152 Feb	Switches, panel, miniaturization of electronic equipment—special report	195 Oct	Test equipment, dual triode tester measures tube balance	194 Mar
Sleeve radiator for tv reception, Kearse	208D Mar	Switching, core tester	242D Oct	Test equipment, flight simulator tests fire-control radars	168 June
Slides, tv chains	182 July	Switching, high current	244D Oct	Test equipment, for checking tube grid emission	238D Mar
Slides, monochrome, broadcast color	169 Mar	Switching, transistor, speed of	190 Mar	Test equipment, for measuring inter-electrode capacitance	220D Apr
Slow-scan adapter for conventional tv signals, Altes, S. K. & Reed	153 June	Symmetry, complementary	200D Sept	Test equipment for transistor production, Jacobsen & Tinsley	148 Oct
Small missile recorder	228D Mar	Sync generator for dot-interlace tv, Thompson	170 Aug	Test equipment, ground-controlled drone tests missiles	182 Mar
Solar-flare detection for IGY, Lee	162 Mar	Sync, noise gating tube for	172 May	Test equipment, high speed strobe checks tube vibrations	224D Feb
Solar powered electric fence charger, Isaacs	188D Dec	Synchronization, picture-to-audio	143 Sept	Test equipment, magnetically-deflected 21-inch oscilloscope	159 July
Soldering, miniaturization of electronic equipment—special report	202 Oct	Synchronization, tv, transistors sync portable tv camera	168 July	Test equipment, for measuring parameters of junction transistors	174 Aug
Soldering, ultrasonic iron solders aluminum	168 Oct	Synchronizer, digital, used in transistor multiplex teletypewriter	150 Sept	Test equipment, measuring particle-induced ignition by counter circuits	150 May
Soldering & Bonding Techniques				Test equipment, portable transistor frequency standard	194D June
Adhesive replaces solder for watt-meter magnets, Gould	236D May	TACAN, air-ground data link	194D May	Test equipment, preset gating unit for aeroballistic testing	164 May
Automatic timing of relay springs	244D Jan	TACAN, Vortac beacons	156 June	Test equipment, production, core tester simplifies ferro-amplifier design	150 Aug
Broad vibrator for dip soldering machine	228D June	Tape, magnetic, controls projector synchronism	143 Sept	Test equipment, reference generator for ssb systems	152 Feb
Conductive wax makes battery connections	244D Aug	Tape recorder selects radio announcements, Drenner	158 Oct	Test equipment, speed indicator for hydraulic servo systems	188 May
Miniature soldering iron	274D Mar	Tape, video recording, used in revolving heads	138 Aug	Test equipment, time-measuring, uses interleaved pulse technique	186 Apr
Solder-flux dispenser	294D Mar	Telephone, Paris, subscriber services	226D Apr	Test equipment, transistor beta tester	198D May
Solder preform serves also as heat sink	236D Apr	Telephone, rural carrier system uses transistors	146 Aug	Test equipment, transistor beta tester	212D Aug
Soldering wave in pot replaces dip soldering	248D Aug	Telemetering, see also radar, data gathering, measurement, recorder		Test equipment, used to check magnetic drum operating characteristics	161 Apr
Soldering aluminum coils	256D Apr	Telemetering, automatic data plotter for	182 Aug	Test equipment, v-f sweep generator determines power gain parameter of transistors	201 Mar
Soldering aluminum with vibrating brush on iron	230D Apr	Telemetering, buoy telemeters ocean temperature data	164 June	Test, Foucault knife-edge, for focusing oscilloscope cameras	192D
Soldering aluminum without fluxing or cleaning	222D Dec	Telemetering, missile uses transistor amplifier	170 May	Tester checks grid emission, Bramsen	238D Mar
Ultrasonic soldering of silicon and germanium	246D Apr	Telemetering, of ocean data by bathythermometer	142 May	Testing, see also measurement, test equipment, meter, instrument	238D Mar
Wrapping of leads cuts quality of soldered joints at terminals	240D Aug	Telemetering, radar, trains pilots	148 Nov	Testing, antenna test chamber	212D Sept
Solid state, see also diodes, transistor		Telemetering, rocket gathers weather data	196D Sept		
Sonar, tracks tagged fish	156 Apr	Telemetering, strain gage system for aircraft	170 Oct		
Sonic, chronograph times supersonic models in wind tunnel tests	152 Apr	Telemetering system is balloon borne, Novak	155 Sept		
Sonic equipment, analyzer for tracing precise curves	184 Mar	Television, control for tv slide chains	182 July		
Sonic, ultra, elastic moduli measurement	214D Sept	Television, color, indicator simplifies tuning	194D Nov		
Sonic, ultra, equipment brewery	162 July				
Sonic, ultra, iron solders aluminum	168 Oct				
Sonic, ultra, tracer follows fish	156 Apr				
Sonic, ultra, transducer tweeter	192D Apr				
Sorting, capacitor	177 July				
Sound, see also sonic audio					
Sound, a-f induction signaling	180 June				
Sound and video, single-carrier system for	151 Jan				
Sound, delay-line audio	200D May				

- Testing, electrical noise interference, shield for aircraft and missiles 236D Aug
- Testing, electronics controls gas chromatography 164 Nov
- Testing, flat field generator speeds color tv check 139 Dec
- Testing, long scope probe for checking digital computers 206D Sept
- Testing, photoelectric target for missile tests 141 Nov
- Testing, power amplifier for aircraft and slipboard servo systems 176 May
- Testing, production, bridge sorts capacitors to tolerance 177 July
- Testing, radiation effects on magnetic materials 200D Oct
- Testing, stroboscope measures shaft torque 147 June
- Testing Techniques**
- Automatic tapper for vacuum-tube testing, Meagher 250D Feb
- Cable tester for fire control systems 238D June
- Card-programmed automatic tester for ganged potentiometers 224D Sept
- Card-programmed transformer winding resistance tester 224D July
- Chassis rack pivots and rotates on test bench 230D Feb
- Checking end play in servo motors 252D July
- Electronic gage sorts mica automatically 228D July
- Lab benches have outlets for three power services 214D Dec
- Leak detector for hermetic seals, Schumacher 234D Mar
- Sound booth reduces shaker noise during vibration tests 222D June
- Transformer turns-ratio tester has digital read-out 222D June
- Tetrajunction transistor simplifies receiver design, Farber, Proudfit, St. John & Wilhelmson 148 Apr
- Tetrodes, meltback, high-frequency circuits use 177 June
- Thermistors compensate transistor amplifiers, Wheeler 169 Jan
- Thermostat, oven, inexpensive 222D Oct
- Three-dimensional printed wiring, Guditz 130 June
- Three oscillator designs standardize circuitry, Gruen 177 Aug
- Thyratron, see also tube
- Thyratron, grid-operated 214D Oct
- Thyratron, wide range a-c timer uses 234D Oct
- Thytrons control die-cutting machine, Bradley 162 Jan
- Thytrons oust rotary selector in mobile phone, Ornstein 150 Nov
- Thytrons stabilize induction heaters, Fraser & Hopkins 152 July
- Time-signal broadcast sets electric clock, Ives 174 July
- Timer, a-c, wide range 240D Oct
- Timer, digital, used to boost readout time of printer 182 June
- Timer, for measuring supersonic models in wind tunnel tests 152 Apr
- Timer, gate tube generates interleaved pulse chain 186 Apr
- Timer, preset gating unit for aerobalistic testing 164 May
- Tone, standard, dual fork driven 196D Feb
- Tones monitor heart's electrical action, Morris & Swanson 160 Nov
- Tools, special, miniaturization of electronic equipment—special report 202 Oct
- Toroid, field direction oscillator 208D Feb
- Toroid measures spot weld current, Zimmerman 132 Dec
- Torsional wave delay lines 212D July
- Tower air monitor for broadcasters 190D Jan
- Toys, radio-controlled 190D Sept
- Tracking, ultrasonic, to follow tagged fish 156 Apr
- Tracks, magnetic sound recording 192D Aug
- TRADIC, clock for 196D June
- Trainer, navigation, controls ship models 172 Sept
- Transceiver, dual-purpose circuitry cuts size of 134 Dec
- Transceiver, 6-meter, superregenerative transistor 180 Apr
- Transducer, magnetostriction, used to bubble beer in brewery 162 July
- Transducer, miniaturization of electronic equipment—special report 185, 194 Oct
- Transducer, ultrasonic, tweeter 192D Apr
- Transducer, used in measuring ocean temperature 142 May
- Transducer, tracking fish 156 Apr
- Transformer, d-c 224D May
- Transistor, see also semiconductor, diode, germanium, silicon, junction**
- Transistor, airborne infrared warning system measures 190D
- Transistor amplifier for medical recording, McKinley & Richards 161 Aug
- Transistor amplifier, thermistors compensate 169 Jan
- Transistor amplifier, used in missile telemeter 170 May
- Transistor amplifier used with crystal pickups 181 May
- Transistor, audio induction paging system 178 Feb
- Transistor, audio mixer for tape recording 248D Oct
- Transistor, automobile receiver 192D Sept
- Transistor, basic logic circuits for computer applications 196 Mar
- Transistor, bathythermometer amplifier 194D July
- Transistor, bathythermometer telemeters ocean data 142 May
- Transistor beta tester, Montgomery 198D May
- Transistor beta tester, Harmer 212D Aug
- Transistor, boosting switching speed of 190 Mar
- Transistor, buoy telemeters ocean temperature data 164 June
- Transistor complementary symmetry, Tarul 200D Sept
- Transistor, computer delay unit uses semiconductor conversion formulas 173 July
- Transistor, hybrid parameters 183 Apr
- Transistors, crystal oscillators have high temperature stability 218D Oct
- Transistor, demodulator-limiter for control system signals 155 Sept
- Transistor, detector for locating ducts and pipes 172 Jan
- Transistor, determining power gain of by v<sub>f</sub> sweep generator 201 Mar
- Transistor, ERNIE computer 138 July
- Transistor, high-frequency circuits use meltback tetrodes 177 June
- Transistor, high-reliability counter 171 June
- Transistor, high-speed computer stores 2.5 megabits 162 Oct
- Transistor, infrared detector aids medical diagnosis 155 Oct
- Transistor, instantaneous speech compressor 168 Feb
- Transistor inverters power Vanguard rocket 203D Apr
- Transistor, junction, measuring parameters of 174 Aug
- Transistor, junction, used in pulse generator 176 Sept
- Transistor life test 204D July
- Transistor, light actuated counter 212D Mar
- Transistor, low power drives r-f power amplifier 214D May
- Transistor, magnetic field pickup follows buried cables 156 Sept
- Transistor, miniaturization of electronic equipment—special report 185 Oct
- Transistor, monovibrator has fast recovery time 158 Dec
- Transistor, navigation trainer control 172 Sept
- Transistor null detector has high sensitivity, Todd 184 Feb
- Transistor phase detector 196D July
- Transistor phonograph preamplifier, Burr 204D May
- Transistor, portable, frequency standard 194D June
- Transistor, portable tv station for remote pickup 170 Feb
- Transistor, preamplifier for ceramic pickups 200D Aug
- Transistor, precise heat for growing silicon crystals 164 Feb
- Transistor, puncher transcribes computer output 164 Dec
- Transistor, push-pull output radio receiver 190D July
- Transistor relays have low idling current, McKinley 147 Dec
- Transistor, remote control receiver 149 Feb
- Transistor, rural carrier system used 146 Aug
- Transistor, S-band transponder used to generate beacon for guided missiles 144 Apr
- Transistor, simple sweep generator 202D Aug
- Transistor, strain gage system for aircraft telemetering 170 Oct
- Transistor, superregenerative 6-meter transceiver 180 Apr
- Transistor Techniques**
- Automatic turntable feeds transistor cap welder 232D Feb
- Juke-box transistor tester lights 210D Aug
- Soaking glasses 240D Aug
- Purifying silicon 242D Sept
- Transistor, test equipment for transistor production check 148 Oct
- Transistor tetrajunction, simplifies receiver design 148 Apr
- Transistor transformer design nomographs, Savant & Savant 204 Mar
- Transistor, transmitter for forty meters 194D Feb
- Transistor tuned oscillators, Armstrong 218D Feb
- Transistor, two-collector for binary full addition 214D Oct
- Transistor, ultrasonic tracer follows tagged fish 156 Apr
- Transistor, unijunction, forms flip-flop 165 Sept
- Transistor, used in crt deflection circuit provides high efficiency 172 Apr
- Transistor, used in amplifiers temperature compensation of 184 July
- Transistor, used in power supply in place of vibrator 224D May
- Transistor, uses annular construction 244D Oct
- Transistor, vif oscillator keys vhf generator 184 May
- Transistor, voltage regulator uses multivibrators 184 Sept
- Transistorized afc uses triangular search sweep, Hoge & Spotten 178 Nov
- Transistorized guidance system feeds chickens, Knight 156 Feb
- Transistorized lab relay, Gill 169 Aug
- Transistorized multiplex radio-teletypewriter, Wray 150 Sept
- Transistorized reactor control 246D Oct
- Transistorized strobe measures shaft torque, Patraiko 147 June
- Transistors boost video for tv studio monitors, Merson 205 Oct
- Transistors, drift, miniature tv camera uses 138 Jan
- Transistors generate geometric scale, Gott & Park, Jr. 180 Jan
- Transistors, irradiating 125 Dec
- Transistors stabilize missile ships, Scheib, Jr. 138 June
- Transistors synchronize portable tv camera, Kinoshita, Fujimura, Kinoshita & Mi 168 July
- Transit time, low, semiconductor amplifier 190D Sept
- Transitions, tapered waveguide, design of 183 Nov
- Transmission line impedance measurement, Mathis 186 June
- Transmission, lossy line filter uses ferrites 204D Apr
- Transmission, rural telephone, carrier system uses transistors 146 Aug
- Transmitter, see also broadcast, communications, uhf, vhf, video, ssb, double sideband**
- Transmitter, airborne fluid cooling of 170 July
- Transmitter, audio clipper extends coverage 204D Feb
- Transmitter, broadcast, automatic changeover 138 Sept
- Transmitter, broadcast modulation monitor 200D July
- Transmitter circuits for suppressed carrier a-m, Costas & French 128 Dec
- Transmitter costs trimmed by series gate modular, Bear 167 Nov
- Transmitter, high power c-w, protection against flash-arc 175 June
- Transmitter, mobile frequency monitor covers tv stations for FCC 152 Oct
- Transmitter, radio, for ionospheric scatter 144 June
- Transmitter, radiotelephone, to speed aircraft communications 164 Apr
- Transmitter, reference generator for ssb system 152 Feb
- Transmitter, selective a-f induction signaling 180 June
- Transmitter, single carrier for sound and video 151 Jan
- Transmitter, single sideband links Canadian traders 174 Oct
- Transmitter transistor, forty meters 194D Feb
- Transmitting tube developments 200D Apr
- Transmitter tuned by distortion indicator, Ellis, Owen & Weatherup 180 Sept
- Transmitter, tv portable station for remote pickups 170 Feb
- Transmitter, tv, transistors sync portable tv camera 168 July
- Transmitter, ultrasonic gong, for control of tv sets 156 Mar
- Transponder, S-band, used to generate beacon for guided missiles 144 Apr
- Traveling wave amplifiers under test 200D Jan
- Trays, for production use**
- Circular plastic trays hold components 236D Apr
- Wood trays hold printed wiring boards 232D Apr
- Tristable gate moves cro line drawings, Ryan 178 May
- Tube, color crt, low voltage gun used in 204D Nov
- Tube, crt, back window 202D Nov
- Tube, crt, deflection circuit for has high efficiency 172 Apr
- Tube, crt display, rectangular darktrace 208D June
- Tube, crt, magnetically-deflected 21-inch oscilloscope 159 July
- Tube, dual-triode, measuring balance of by tester 194 Mar
- Tube, flat, for color tv 190D Feb
- Tube, gating, generates interleaved pulse chain 186 Apr
- Tube, heater surge chart 188 June
- Tube, heaterless, secondary emission 190D Jan
- Tube, high speed strobe checks vibrations of 224D Feb
- Tube, ignitron, rectifier for locomotives 220D Mar
- Tube, image orthicon, motion minimizes burn-in 180 Aug
- Tube, low-mu triodes control power 204D Aug
- Tube, measurement of interelectrode capacitance by means of tester 220D Apr
- Tube, microwave, platinotron increases search radar range 164 Aug
- Tube, movable-anode, transducer 232 Mar
- Tube, noise gating for age and sync 172 May
- Tube, photo, checks razor blades in production 190D June
- Tube Production Techniques**
- Air shipment pack for large magnetrons, Sutherland & Maitland 236D June
- Automatic x-raying of 18,000 tubes a day 230D July
- Chromized grid mandrels resist brazing 284D Oct
- Detecting oil on punched mica parts 234D Jan
- Etching klystron grids 248D Apr
- Heat shields and sinks improve reliability 240D Sept
- Machine inserts tubes in cartons 278D Mar
- Magnetic rings hold tiny tube parts 246D Aug
- New shipping pack swings vacuum tubes in plastic pouches 352D Oct

Transparent conductive tube coatings ..... 20D July  
 Tube, tester checks grid emission ..... 238D Mar  
 Tube, thyatron, grid-operated ..... 214D Mar  
 Tube, thyatrons, stabilize induction heaters ..... 152 July  
 Tube, transmitting, flash-arc ..... 175 June  
 Tube, tv camera pickup ..... 170 Feb  
 Tube, voltage-tuned magnetron ..... 162 May  
 Tubes and transistors, miniaturization of electronic equipment—special report ..... 200 Oct  
 Tubes, thyatrons for controlling die-cutting ..... 162 Jan  
 Tuned oscillators, transistor ..... 218D Feb  
 Tuning, color tv, indicator simplifies ..... 194D Nov  
 Tuning, fork-driven dual tone standard ..... 196D Feb  
 Tuning, transmitter, by distortion indicator ..... 180 Sept  
**TV, see also television**  
 TV checks die positions ..... 220D Oct  
 TV, receivers, galactic noise effects ..... 198D Aug  
 TV, spot wobble cuts tv screen lines ..... 194D Aug  
 Tweeter, ultrasonic ..... 192D Apr  
 Two-channel mixer for tape recording, Ferrara ..... 248D Oct  
 Two-collector transistor for binary full addition ..... 214D Oct  
 Two-megawatt klystron ..... 248D Mar  
 Two-thousand mc scatter link ..... 216D Oct  
 TX-2, computer, stores 2.5 megabits ..... 162 Oct  
 Typewriter, electronic ..... 206D June

**U**

UHF, transmitter tuned by distortion indicator ..... 180 Sept  
**Ultrasonic, see also sonic, sound, generator**  
 Ultrasonic cleaner ..... 224D Mar  
 Ultrasonic gong controls iv sets, Adler, Desnieres & Spracklen ..... 156 Mar  
 Ultrasonic iron solders aluminum, Scarpa ..... 168 Oct  
 Ultrasonic, propagation test ..... 143 Jan

Ultrasonic surgery ..... 228D Aug  
 Ultrasonic tracer follows tagged fish, Trefethen, Dudley & Smith ..... 156 Apr  
 Ultrasonic transducer serves as tweeter ..... 192D Apr  
 Ultrasonic bubbles beer in brewery, Davis ..... 162 July  
 Ultrasonics, measuring elastic moduli by ..... 214D Sept  
 Unijunction transistor forms flip-flop, Keonjian & Suran ..... 165 Sept

**V**

**Vacuum Tube, see also tube**  
 VHF, galactic noise ..... 198D Aug  
 VHF, generator keyed by vlf oscillator ..... 184 May  
 VHF rheostat, Wrigley & Scott, Jr. ..... 196D Dec  
 Vibration, designing airborne equipment for ..... 166 Jan  
**Video, see also television, tv, broadcast, transmitter, receiver, amplifier, recording**  
 Video recorder trains radar observers, Heintz ..... 146 Sept  
 Video recording, electronic shutter ..... 186 May  
 Video recording, new type of recorder uses revolving heads ..... 138 Aug  
 Video scanner matches photo patterns, Oelbermann ..... 154 Aug  
 Video, single-carrier system for sound and ..... 151 Jan  
 Video, tape recorder uses revolving heads, Snyder ..... 138 Aug  
 Video, transistors boost for tv studio monitors ..... 205 Oct  
 VLF oscillator keys vhf generator, Dulberger ..... 184 May  
 Voltage multiplier ..... 236D Mar  
 Voltage regulator uses multivibrators, Scism ..... 184 Sept  
 Voltage-tuned magnetron for f-m applications, Bristol & Griffin, Jr. ..... 162 May  
 VOR-DME, air ground data link to cut stacking ..... 194D Jun  
 VOR-DME, Vortac beacons for rho-theta navigation ..... 156 June  
 Vortac beacons for rho-theta navigation, Caporale ..... 156 June

**W**

WMGM tests CSSB ..... 222D Feb  
**Waveguide, see also microwave, uhf, vhf**  
 Waveguide loss charts, Pomeroy ..... 210 Oct  
 Waveguide, tapered transitions, design of ..... 183 Nov  
 Waves, radio, luminous power from ..... 212D May  
 White Alice link completed in Alaska ..... 192D Jan  
 Wide range a-c timer, Fraser ..... 240D Oct  
 Wide-range analyzer traces precise curves, Feldman ..... 184 Mar  
 Wide-swing choke, Weil ..... 201D July  
**Wire Production Techniques**  
 Cable-stripping knife ..... 254D May  
 Chrome-plated mold for connector potting ..... 233D May  
 Connector holder ..... 230 Apr  
 Conical planetary cable for missiles ..... 232D July  
 Cutting and stripping long coaxial cables ..... 256D Mar  
 Cutting armored cable ..... 252D Apr  
 Ferrule-applying tools for shielded wire ..... 248D May  
 Harness board holder ..... 276D Oct  
 Nylon rollers added to wire-cutting machine ..... 282D Oct  
 Potting of connectors cuts airborne weight, DeLaHaye ..... 230D Sept  
 Rat trap holds plugs ..... 282D Aug  
 Splicing multiconductor shielded cable ..... 232D Dec  
 Spool guard stops snarls on wire rack ..... 234D May  
 Typist's guide minimizes errors in preparing computer cables ..... 228D Apr  
 Ultrasonic welding joins foil to wires, Ware & Fallon ..... 216D Dec  
 Wire holders on nippers ..... 248D Apr  
 Wire-twisting methods ..... 242D Apr  
 Wiring, three-dimensional printed ..... 160 June  
 Writer, electrostyl ..... 206D June

**X**

X-band array, antenna, for guided missiles ..... 166 Mar  
 X-band, ferrite-rod antennas ..... 159 Jan  
 X-ray, level indicator for liquids ..... 196D Jan

# Industry Report Index 1957

**Aircraft**  
 ACSA set up to push development ..... 14 Mar  
 Air Force expands modernization ..... 10 May  
 Aircraft electronics levels off ..... 8 Feb  
 Assembly-line machine-gun ..... 14 May  
 Beacon tells pilot airport heading ..... 22 Oct  
 Bendix analyzer checks spark plugs ..... 24 Jan  
 Carrier aircraft land no hands ..... 7 Oct  
 Computer solve problems ..... 22 Feb  
 Doppler navigation systems ..... 24 Feb  
 Electronics will conquer the poles ..... 14 Jun  
 Flight simulators enter new market ..... 14 May  
 Jet electronic needs add to design problems ..... 16 Apr  
 Manufacturers cash-in on Hustler ..... 26 Feb  
 Plane maker turns to instruments ..... 12 Nov  
 SAC shows B-52 electronics ..... 10 Jan  
 Standards for design and reliability ..... 14 Jul  
 Testing aircraft equipment components ..... 16 Aug  
 Transistorized intercommunications system ..... 16 Aug  
 TWS radar system tracks 72 targets ..... 24 May

**Business and Finance**  
 Amphenol Great Britain Ltd. ..... 12 Aug  
 Custom tubes produce undreamed-of markets ..... 10 Dec  
 Daystrom plans debentures ..... 12 Feb  
 Eitel-McCullough 1956 net profit ..... 12 Jun  
 Electronics boosts magnesium sales ..... 16 Jul  
 Electronics sinks new roots ..... 24 Mar  
 Envelope sales keep growing ..... 26 Mar  
 Exports trail 1956 record ..... 26 Dec  
 GE sales in 1956 ..... 14 Apr  
 General Instrument acquires Radio Receptor ..... 12 May  
 General Transistor issues common Webcor cash dividend ..... 10 Jul  
 Higher sales than in 1956 expected for 1957 ..... 10 Mar  
 Hotels are big market ..... 12 Aug  
 Magnetic recording adds volume ..... 12 Mar  
 Microwave Associates ..... 10 Jul  
 Mid-Continent Manufacturing's Darton Electronics Div. ..... 12 Aug  
 Models mean business ..... 26 Sept  
 NCR debentures ..... 12 Jan  
 New England outlook bright ..... 8 Aug

NICB survey on outlook ..... 12 Oct  
 Radiation safety boosts sales ..... 20 Apr  
 Radio, phonograph sales zoom ..... 7 Jul  
 Semiconductor sales to triple ..... 16 Jan  
 Small sets do big business ..... 20 Mar  
 Vitro Corp of America ..... 10 Sept  
 World radio sets gain 20% ..... 26 Aug

**Communications**  
 Bell Labs TH system eases overload ..... 20 Jul  
 Forward scatter links NATO nations ..... 24 Jul  
 High-band mobile patrols turnpike ..... 22 Aug  
 Mobile radio dials phone calls ..... 7 May  
 Multiplex f-m gathers momentum ..... 8 Mar  
 National Bureau of Standards broadcast for IGY ..... 28 Aug  
 Nations plan North Atlantic link ..... 8 May  
 Old tubes ..... 16 Oct  
 Passive radar techniques uses microwave waves ..... 7 Aug  
 Push button dialing radiotelephone ..... 12 Oct  
 Tellurometer with radiotelephone ..... 10 Sept  
 Tropo-scatter begins to hop ..... 7 Jul  
 Utilities eye microwave channels ..... 22 Sept

## Computers

Advertiser aids ICBM tests ..... 18 Jul  
Board Plots Business Trends ..... 16 Dec  
Business demands more computers ..... 26 Apr  
Cal Tech man teaches computer how  
to translate ..... 16 Aug  
Centers increase fast ..... 22 Mar  
Computer applications increase ..... 14 Sept  
Computer approaches 5,000 mark ..... 8 Nov  
Computer solves problems in flight  
test data reduction ..... 22 Feb  
Computer use in industry expands ..... 20 Jan  
Computers replace celestial dome ..... 16 Oct  
Datatron ..... 26 Oct  
Digital computer completely transi-  
storized ..... 26 Aug  
Electronic strategist directs defense ..... 22 Jul  
Electronics dissolves data storage  
pile-up ..... 7 Apr  
High-speed TRANSAC C-1 ..... 16 Aug  
Instrument makers appraise de-  
velopments ..... 8 Oct  
Market takes on more computers ..... 26 Jun  
MIDAC ..... 20 Jan  
Military spurs computer work ..... 16 May  
Mobile combat computer, MOBIDIC ..... 16 Aug  
More computers go to colleges ..... 7 May  
More railroads choose electronics ..... 20 May  
New application on TV ..... 20 Jan  
New concept in memory devices ..... 7 Dec  
New transistorized digital compu-  
ter ..... 16 Aug  
Oil industry looks to computers ..... 22 Dec  
Plug-in type computer uses printed  
circuits ..... 24 May  
Radar-computer finds mortars ..... 26 Mar  
Soldering irons build IBM compu-  
ters ..... 26 May  
Special-purpose, transistor-magnetic  
analog computer ..... 16 May  
University of Pennsylvania computer  
center ..... 18 Jul  
Vanguard Computer Center rehearses ..... 7 Nov

## Foreign Electronics

Britain builds proton synchrotron ..... 28 Oct  
Britain pushes airborne controls ..... 20 Nov  
Britain tv license ..... 26 Sept  
British infrared radar for aircraft  
detection ..... 28 Jan  
British leading manufacturers ex-  
pect public demand for tv sets ..... 8 Jul  
British tv service ..... 28 Jun  
Computer marks auto speed in  
Le Mans race ..... 8 Aug  
Computers multiply ..... 7 Mar  
Cyprus to have regular television  
transmissions ..... 28 Jun  
Czechoslovakia will import 73,000  
Soviet tv sets ..... 28 Oct  
Denmark television stations to be  
built ..... 26 Jul  
Devices advance British electronics ..... 20 Sept  
Forward scatter links NATO ..... 24 Jul  
Japanese firms may make U S  
radios ..... 24 Sept  
Licenses for tv stations ..... 26 Jul  
Magnification of 500,000 ..... 16 Jun  
Modular systems opens plant ..... 28 Mar  
Mullard's new plant ..... 28 Apr  
Netherlands business develops more  
favorably ..... 12 Feb  
Output of electronic output in capital  
goods ..... 28 Mar  
Poland agrees to buy \$14 million  
worth of tv sets ..... 28 Oct  
Poland demands production of 16-  
000 tv sets ..... 28 Oct  
Production of transistors ..... 26 Jul  
Propaganda expenditures of Russia ..... 28 Aug  
Radio astronomy maps the universe ..... 8 Sept  
Radio equipment ..... 28 Apr  
Radio equipment ..... 26 Sept  
Scotland TV ..... 26 Sept  
Soviets develop underwater camera ..... 8 Jun  
Tape recorders ..... 28 Jan  
Three companies appoint subcon-  
tractors ..... 28 Jun  
Trans-Atlantic phone cable ..... 7 Jun  
TV keeps growing ..... 16 Jul  
Ultrasonic uses cited ..... 24 Oct  
U S visits USSR tv plants ..... 28 Oct  
West German radio and tv indus-  
try ..... 28 Feb  
World radio sets gain 20% ..... 26 Aug

## Government

U. S. aids contract financing ..... 14 Jan  
*Federal Communications Commission*  
Deintermixing vhf and uhf tv ..... 22 Apr  
FCC adds vhf's Petition from  
Transmix ..... 22 May  
FCC amended motor carrier rules ..... 22 Mar  
FCC amends Industrial, Scientific  
& Medical Service rules ..... 22 Oct  
FCC amends railroad radio rules ..... 22 Apr  
FCC appoints Irving Brownstein  
Chief of Law ..... 22 Sept  
FCC arranges with FTC to receive  
copies of complaints ..... 22 Apr  
FCC AT&T and RCA Communica-  
tions hearing ..... 22 May  
FCC authorizes Baptist Church  
programs ..... 22 Aug  
FCC bid to liberalize radiation  
and power-line ..... 22 May

FCC ceases to issue more f-m  
broadcast ..... 22 Aug  
FCC cracks down on vessels with-  
out radiotelephone ..... 22 Sept  
FCC extends renewal license  
periods in Public Safety ..... 22 Jul  
FCC grants RCA Communications  
subchannels ..... 22 Sept  
FCC grants to RCA Communica-  
tions special permission-rates ..... 22 Jul  
FCC invites comment on proposals  
relative to frequencies ..... 22 Apr  
FCC okay's public use of devices  
with telephones ..... 22 Jul  
FCC permits West Coast Telephone  
to file comments ..... 22 Sept  
FCC proposes to terminate lenient  
granting of STA status ..... 22 Apr  
FCC request for changes in regu-  
lations—remote control ..... 22 Mar  
FCC sets up committee to prepare  
U S proposals ..... 22 Aug  
FCC splits Office of General Coun-  
sel divisions ..... 22 Jul  
FCC studies f-m broadcast stations  
antenna systems ..... 22 Oct  
FCC studies switch in class B f-m  
allocations ..... 22 Sept  
FCC to receive copies of advertis-  
ing complaints from FTC ..... 22 Apr  
FCC to study frequency alloca-  
tions—25 to 890 mc ..... 22 May  
FCC warned prospective users  
against investment ..... 22 May  
John C. Doerfer becomes chair-  
man ..... 22 Aug

## Industry

Boosts plant expansion for 1957 ..... 7 Jan  
British radio equipment exports ..... 26 Sept  
Electronics shares oil spending ..... 12 Jul  
Electronics work force expands ..... 8 Apr  
Experience boosts engineer's sala-  
ries ..... 12 Apr  
GE trains closed-circuit tv service-  
men ..... 28 Jan  
Industry convention ..... 16 Mar  
Industry's plant build up ..... 8 Apr  
Motorola's transistor car radio ..... 28 Feb  
Noncommercial educational tv ..... 26 May  
Printed wiring sets new record ..... 8 Jan  
Puerto Rico plant makes modules ..... 28 Mar  
Radio shipments ..... 28 Oct  
Railroads choose electronics ..... 19 May  
R&D takes half of engineers ..... 26 Feb  
Sonar sales register growth ..... 7 Feb  
Sour microwave tube output ..... 14 Dec  
Transistor limited in radio-tv ..... 14 Dec  
TV tube renewal sales increase ..... 18 May  
Utah Co acquires projection tv ..... 28 Mar  
VHF controls power plants ..... 24 Aug

## Materials

Dollar volume of phenolic resin  
used annually ..... 28 Apr  
Electronics adds air conditioning ..... 26 Feb  
Electronics boosts sales for mag-  
nesium ..... 16 Jul  
Gaseous diffusion aids transistors ..... 28 Aug  
Gases produce power by the kilo-  
watt ..... 22 Oct  
Germanium unaltered by some im-  
purities ..... 26 Oct  
Hoffman Electronics solar cell port-  
able radio ..... 19 Feb  
Industry exploits diodes ..... 14 Oct  
Magnetic cores add volume ..... 22 May  
Magnetics catch on ..... 10 Mar  
MRT-IRE Brooklyn symposium re-  
view of solid state ..... 24 Jun  
Phosphors find new markets ..... 24 Apr  
Power transistors get toehold ..... 10 Apr  
Poly output climbs ..... 16 Apr  
Usually low bar to pure germa-  
nium converts to 80,000 crystals ..... 14 Jan  
Silicon output increases ..... 16 May  
X-rays analyze tiny parts failures ..... 10 Jul

## Medical Electronics

Apparatus for coaxing new-born  
babies to breathe ..... 22 Sept  
Blood pressure vein check ..... 20 Dec  
Color tv views living cells ..... 20 Oct  
Doctors evaluate electronics ..... 12 Nov  
Magnetic bills used at University of  
California ..... 26 Jul  
Medical research tests electronics ..... 14 Oct  
Techniques now indispensable to  
hospitals ..... 8 Jul  
Utilization of quartz fiber ..... 20 Apr

## Military

Airborne infrared detector ..... 14 Jul  
Armament-control system for Doug-  
las F4D ..... 20 Jun  
Army takes transistor plunge ..... 8 Jan

Cutback to four-day week at missile  
plant ..... 10 Apr  
Electronic data processing machine  
at Hill AFB ..... 16 Aug  
Electrons sterilize Army foods ..... 16 May  
Functional & environmental tests ..... 16 Oct  
Guidance system production con-  
tracts for Talos & Terrier ..... 16 Oct  
Hughes airborne control system ..... 18 May  
Interest in projection television ..... 20 Jun  
Lincoln Lab reports reliability for  
SAGE computer ..... 14 Jul  
Mack Trucks receives Navy con-  
tract ..... 10 Apr  
Military uses more civil radar ..... 8 Dec  
*Military Purchases*  
Aircraft electronics levels off ..... 8 Feb  
Army takes transistor plunge ..... 8 Jan  
Electronics-for-defense rises ..... 26 Jun  
Military research pays off ..... 16 Jun  
U S aids contract financing ..... 14 Jan  
Miniaturization trend continues ..... 24 Jul  
Missile guidance system contract for  
sub-launched Regulus ..... 18 May  
Missile spending keeps soaring ..... 7 Jun  
Mobile combat computer for solving  
military problems ..... 16 Aug  
New Falcon GAR-2A ..... 14 Sept  
Spending rising ..... 20 May

## Missiles

Air Force ballistic program pro-  
gresses ..... 28 Apr  
Aircraft electronics levels off ..... 8 Feb  
Bomarc gets ready for production ..... 22 Feb  
Console guides airborne missiles ..... 24 May  
Functional & environmental tests ..... 16 Oct  
Hawk integrated into Missile Master  
system ..... 14 Sept  
ICBM computer-converter aids tests ..... 18 Jul  
Improved missiles readied for use ..... 7 Apr  
Inertial guidance wraps take wing ..... 10 Jun  
Missile research gets hotter ..... 16 Nov  
Navy awards Convair contract for  
Terrier guidance ..... 24 Feb  
Navy unveils operational version  
of Talos ..... 14 Aug  
Prime production contracts for Ter-  
rier guidance radars ..... 16 Oct  
Production contracts for guidance  
systems ..... 16 Oct  
Production contracts for Navy's  
Talos ..... 16 Oct  
RCA radar system scores missile ..... 8 May  
Signal-enhanced radar adds DX ..... 7 Sept  
Snark finds its way with gyros ..... 12 Mar  
Stand-in Lockheed's three-stage  
X-17 Atlas missile ..... 28 Mar  
Thor test and launching equipment ..... 24 Feb  
Tracker evaluates missile worth ..... 22 Jun

## Production

Dual triode unit reduces components  
needed in manufacture ..... 26 Apr  
Electronics steps up stampings ..... 26 Jan  
Machine tools speeds defense work ..... 20 Sept  
Printed circuit techniques ..... 8 Oct  
Punched tape robot ..... 8 Nov  
Rack cuts test time one-third ..... 20 Aug  
Transistors aim for industrial con-  
trol ..... 14 Jul  
Transistors control machine tools ..... 22 Jan  
Ultrasonic drill by Lockheed ..... 28 Aug

## Research and Development

Atomic-powered batteries ..... 14 Mar  
Density gage ..... 24 Oct  
Electronics checks pitcher's speed ..... 20 Apr  
Electronics helps the blind ..... 24 Dec  
Experimental radio service ..... 20 Mar  
Future of switching ..... 12 May  
Gases produce power ..... 22 Oct  
Industry exploits diodes ..... 14 Oct  
Magnetrons improve ephors ..... 24 Mar  
Magnets make new advances ..... 16 Feb  
Metal Identifying Analyzer ..... 20 Nov  
Microwave cooking ..... 12 Sept  
New amplifier gains forecast ..... 7 Mar  
New speeds shape up for tape ..... 26 Apr  
Panel amplifier shows X-ray image ..... 24 Nov  
Parachuting weather station ..... 20 Jul  
Sign flashes auto speed warning ..... 8 Aug  
Spacistor ..... 10 Aug

## Television

Bank teller-vision hastens service ..... 20 Aug  
British push simpler flat tv tube ..... 14 Jan  
Closed-circuit tv guards New York  
subway ..... 26 Aug  
Color tv shows progress ..... 14 Feb  
Image orthicon tube life extended ..... 12 Sept  
Second set market looms large ..... 10 May  
Signal Corps to get airborne vidicon  
camera ..... 14 Jul  
Steps taken to aid UHF tv ..... 14 Apr  
Vertical blanking interval ..... 8 Jan

# AUTHOR INDEX

Dudley, J. W., Smith & Trefethen, Ul-  
trasonic tracer follows tagged  
fish ..... 156 Apr  
Dulberger, L. H., VLF oscillator keys  
whf generator ..... 184 May

## A

Abelew, H. H. & Sarratt, Ship auto-  
alarm uses computer techniques ..... 180 Feb  
Adler, R., Desmares & Spracklen, Ul-  
trasonic gong controls tv sets ..... 156 Mar  
Adler, S. & Biser, Servo Analysis  
chart ..... 173 Dec  
Agresti, F., Determining grounded  
grid operation ..... 230D Aug  
Alden, W. B., Wyeth & Davis, Precise  
heat for growing silicon crystals ..... 164 Feb  
Altes, S. K. and Reed, Slow-scan  
adapter for conventional tv sig-  
nals ..... 153 June  
Andrea, J. & Gilson, Integrating cir-  
cuit for direct recorder ..... 216D Feb  
Arany, D. & Cohen, Subminiature  
beacon for guided missiles ..... 144 Apr  
Armstrong, H. L., Pulsed light tests  
minority-carrier life ..... 145 Aug  
Armstrong, H. L., Simple transistor  
sweep generator ..... 202D Aug  
Armstrong, H. L., Transistor tuned  
oscillators ..... 218D Feb  
Aranson, A. I., & Chong, Monovibrator  
has fast recovery time ..... 168 Dec  
Atwood, K., Intercarrier failure rings  
alarm ..... 188 Mar

## B

Baer, R. H., Transmitter costs trimmed  
by series gate modular ..... 167 Nov  
Baker, D. W., High-frequency circuits  
use meltback tetodes ..... 17 June  
Baker, R. H., Boosting transistor  
switching speed ..... 190 Mar  
Barrett, E. T. & Smith-Vaniz, Morse-  
to-teletypewriter code converter ..... 154 July  
Barrick, W. E. & Brannon, Beacon  
antennas for guided missiles ..... 166 Mar  
Barritt, R. C., Phase-shift oscillator  
indicates radar range ..... 160 Oct  
Barton, H. O. & Gimpel, Computer in-  
ventories oil in refinery tanks ..... 143 Oct  
Belby, M. & Mercurio, Designing air-  
borne equipment for vibration ..... 166 Jan  
Belfield, M. D., Selector chooses c-w  
phase ..... 202D May  
Bell, R. M., Molded flush wiring for  
printed circuits ..... 260D Oct  
Bequaert, F. & Wise, Universal etched  
circuit for plug-in units ..... 230D June  
Berkley, C., Mansberg & Yamagami,  
Spot scanner counts micron-sized  
particles ..... 142 Dec  
Bernstein, S., Avoiding blown fuses  
with capacitive loads ..... 218D Nov  
Beyer, D. S., Portable transistor fre-  
quency standard ..... 194D June  
Birch, J. K., Jukebox and tape auto-  
matic radio shows ..... 156 Nov  
Biser, E. & Adler, Servo Analysis  
chart ..... 173 Dec  
Bishop, R., Attenuator box er-  
rors ..... 216D June  
Blair, W. L., Receiver detects signals  
below noise level ..... 168 Sept  
Bohr, E., Remote control receiver ..... 149 Feb  
Bonn, T. H., Magnetic computer has  
high speed ..... 156 Aug  
Booth, G. W. & Bothwell, Basic logic  
circuits for computer applications ..... 196 Mar  
Bothwell, T. P., Basic logic circuits for  
computer applications ..... 196 Mar  
Bozarsky, L. L., Grid-operated thyra-  
tron ..... 214D Mar  
Boyle, S., Design and manufacture of  
practical filter circuits ..... 154 Dec  
Bradley, R. W., Thyratrons control  
die-cutting machine ..... 162 Jan  
Bramsen, E. A., Tester checks grid  
emission ..... 238D Mar  
Brannon, D. L. & Barrick, Beacon an-  
tennas for guided missiles ..... 166 Mar  
Breskend, S. D., Cooperman & Frank-  
lin, Bridge sorts capacitors to tol-  
erance ..... 177 July  
Bristol, T. R. & Griffin, Jr., Voltage-  
tuned magnetron for f-m applica-  
tions ..... 162 May  
Brooks, W. O. & Stephenson, Strain  
gage system for aircraft telemeter-  
ing ..... 170 Oct  
Brown, W. C., Platinotron increases  
search radar range ..... 164 Aug  
Hubb, E. L., Fenson & Hayward,  
Computer selects premium bond  
winners ..... 138 July  
Burr, R. E., Transistor phonograph  
preamplifier ..... 204D May

## C

Caporale, P., Vortac beacons for rho-  
theta navigation ..... 156 June  
Carroll, J. M. & Webster, Magnetic  
field pickup follows buried cab-  
les ..... 156 Sept  
Carter, D. F., Parallel-T nomo-  
graph ..... 192 Nov  
Casement, J. S. & Herr, Coated-filler  
resin speeds encapsulation ..... 258D Aug  
Cawley, Jr., J. H., Bathythermometer  
amplifier ..... 194D July  
Cawley, Jr., J. H. & Snogross, Bathy-  
thermometer telemeters ocean data  
..... 142 May  
Chaffin, N. L., Pertinent patents ..... 216D July  
Chaffin, N. L., Pertinent patents ..... 216D Sept  
Chapman, S., Hendrick & Martin,  
Measuring corona from radioactive  
point ..... 172 Mar  
Chatterton, E. J., Galpin & Tombs,  
Applications of corona effects ..... 198D July  
Chisholm, H. C., High-reliability tran-  
sistorized counter ..... 171 June  
Chong, C. F. & Aronson, Monovibrator  
has fast recovery time ..... 168 Dec  
Chow, W. F., Superregenerative tran-  
sistor transceiver ..... 180 Apr  
Cleland, A. L., Flattening response of  
crystal pickups ..... 181 May  
Coblentz, A., Semiconducting com-  
pounds ..... 144 Nov  
Coffey, W. N., Sweeper determines  
power-gain parameter ..... 201 Mar  
Coffman, B. C., Horner & Crosby,  
Single sideband links Canadian  
traders ..... 174 Oct  
Cohen, M. & Arany, Subminiature  
beacon for guided missiles ..... 144 Apr  
Collins, W. H., Schmidt & Hollis,  
Radio transmitter for ionospheric  
scatter ..... 144 June  
Cook, R. W., Flat field generator  
speeds color tv testing ..... 139 Dec  
Cooperman, J. I., Franklin & Bres-  
kend, Bridge sorts capacitors to tol-  
erance ..... 177 July  
Corden, C. & Warren, Ground-control-  
led drone tests missiles ..... 182 Mar  
Costas, J. P. & French, Transmitter  
circuits for suppressed carrier a-m 128  
Dec  
Costello, R. J. & McMichael, Large  
shielded enclosure ..... 236D Aug  
Cottrell, D. E., Binary-decimal counter  
operates at 10 mc ..... 186 Nov  
Covington, E. L., Monochrome slides  
broadcast color ..... 169 Mar  
Crane, N. B., Inexpensive oven ther-  
mostat ..... 222D Oct  
Crocker, D. C., Electronic shutter for  
tv kinescope recorder ..... 186 May  
Crosby, M. G., Horner & Coffman,  
Single sideband links Canadian trad-  
ers ..... 174 Oct  
Cutler, S. & George, Electronic organ  
uses shared oscillators ..... 167 May

## D

Davis, A. S., Ultrasonics bubbles beer  
in brewery ..... 162 July  
Davis, E. T., Alden & Wyeth, Precise  
heat for growing silicon crystals ..... 164 Feb  
Day, R. L., Mobile monitor covers tv  
stations for FCC ..... 152 Oct  
Degelman, J., Low-mu triodes control  
power ..... 204D Aug  
Deinel, E. O., Impregnating toroids  
for high temperatures ..... 240D June  
DeLaHaye, C., Potting of connectors  
cuts airborne weight ..... 230D Sept  
DeMeyer, D. L., Flight simulator tests  
fire-control radars ..... 168 June  
Desmares, P., Spracklen & Adler, Ul-  
trasonic gong controls tv sets ..... 156 Mar  
Diamantides, N. D., Pen recorder reso-  
lution increase ..... 210D Nov  
Diamond, J. M., Power amplifier for  
servo testing ..... 176 May  
Diegert, M. B., Back window cathode  
ray tube ..... 202D Nov  
Dimeff, J. & Fryer, Capacitance pickup  
measures small forces ..... 143 Feb  
Dlugatch, I., Low power drives  
p-a ..... 214D May  
Donner, W., Electronics controls gas  
chromatography ..... 164 Nov  
Dorsey, S. E., Photoelectric target for  
missile tests ..... 141 Nov  
Dorsey, S. E., Preset gating unit for  
aeroballistic testing ..... 164 May  
Drenner, D. V. R., Tape-recorder selects  
radio announcements ..... 158 Oct

## E

Ellis, C. R., Owen & Weatherup,  
Transmitter tuned by distortion in-  
dicator ..... 180 Sept

## F

Fallon, J. W., Printed circuit micro-  
wave attenuator ..... 216D Mar  
Fallon, J. & Ware, Ultrasonic weld-  
ing joins foil to wires ..... 216D Dec  
Farber, R. J., Proudft, St. John and  
Wilhelmsen, Tetrajunction tran-  
sistor simplifies receiver design ..... 148 Apr  
Feldman, E. F., Wide-range analyzer  
traces precise curves ..... 184 Mar  
Fenson, H. W., Hayward & Bubb,  
Computer selects premium bond  
winners ..... 138 July  
Ferrara, R. C., Two-channel mixer for  
tape recording ..... 248D Oct  
Feyerherm, M. P., Heater surge  
chart ..... 188 June  
Findlay, D. A., Miniaturization of elec-  
tronic equipment—special report ..... 177 Oct  
Fischer, F. C., Gerlach & Schover,  
Air-drop system broadcasts mes-  
sage ..... 179 Mar  
Fitch, M. E., Weller & Schubring,  
Counter circuits analyze ignition ..... 150 May  
Fleming, L., Silicon diode chopper  
stabilizes d-c amplifier ..... 178 Jan  
Flory, L. E., Gray, Morgan & Pike,  
Miniature tv camera uses drift tran-  
sistors ..... 138 June  
Flory, L. E., Gray, Morgan & Pike,  
Portable tv station for remote pick-  
ups ..... 170 Feb  
Franklin, P. J., Breskend & Cooper-  
man, Bridge sorts capacitors to tol-  
erance ..... 177 July  
Frantz, Jr., D. N., Walden & Ketchum,  
Buoy telemeters ocean temperature  
data ..... 164 June  
Fraser, H. J. & Hopkins, Thyratrons  
stabilize induction heaters ..... 152 July  
Fraser, H. J., Wide range a-c  
timer ..... 240D Oct  
Freedman, A. L., Magnetic core coin-  
cidence circuit ..... 194D Aug  
Frei, E. H. & Treves, Clip-on milliam-  
meter uses magnetic amplifier ..... 204D Jan  
French, R. W. & Costas, Transmitter  
circuits for suppressed carrier a-m 128  
Dec  
Fryer, T. B. & Dimeff, Capacitance  
pickup measures small forces ..... 143 Feb  
Fujii, T. & Kojima, R-f power supply  
for infrared viewers ..... 163 Nov  
Fujimura, Y., Kihara, Mii & Kino-  
shita, Transistors synchronize port-  
able tv camera ..... 168 July  
Fuller, E. J., Pulse generator uses  
junction transistors ..... 176 Sept

## G

Galpin, K., Tombs & Chatterton, Ap-  
plications of corona effects ..... 198D July  
Gesser, D. T., Meter shows current  
drift from nominal ..... 192D Dec  
George, T. J. & Cutler, Electronic or-  
gan uses shared oscillators ..... 167 May  
Gerlach, A. A., Schover & Fischer,  
Air-drop system broadcasts mes-  
sage ..... 179 Mar  
Gettings, H. W., Digital printer boosts  
readout time ..... 182 June  
Gignoux, D., Electrostatic generator  
has high stability ..... 192D July  
Gill, H. A., A., Transistorized lab re-  
lay ..... 169 Aug  
Gilson, W. E. & Andrea, Integrating  
circuit for direct recorder ..... 216D Feb  
Gimpel, D. J. & Barton, Computer in-  
ventories oil in refinery tanks ..... 143 Oct



Goldberg, A. A., Indicator simplifies color tv tuning.....194D Nov  
 Golhany, Y., Silicon diodes as logarithmic elements.....196D Aug  
 Goodykoontz, J. R., Coil winder for miniature toroids.....256D Jan  
 Gordon, S. H., Compensating silicon transistor amplifiers.....184 July  
 Gott, E. & Park, Jr., Transistors generate geometric scale.....180 Jan  
 Gould, B., Adhesive replaces solder for wattmeter actuators.....236 May  
 Grant, J., Light actuated transistorized counter.....212D Mar  
 Gray, G. W., Morgan, Pike & Flory, Miniature itv camera uses drift transistors.....138 Jan  
 Gray, G. W., Morgan, Pike & Flory, Portable tv station for remote pickups.....170 Feb  
 Greenwood, J. H., Automatic change-over of radio transmitters.....138 Sept  
 Griffin, Jr., G. J. & Bristol, Voltage-tuned magnetron for f-m applications.....162 May  
 Gruen, H. E., How to design Colpitts crystal oscillators.....146 Jan  
 Gruen, H. E., Three oscillator designs standardize circuitry.....177 Aug  
 Guditz, E. A., Three-dimensional printed wiring.....160 June  
 Guggl, W. B., CRT deflection circuit has high efficiency.....172 Apr

**H**

Hajic, E., Peterson, Ulander & Hargis, Microwave remotes aid air traffic control.....144 July  
 Hargis, R. N., Peterson, Ulander & Hajic, Microwave remotes aid air traffic control.....144 July  
 Hargreaves, Jr., W. V., Graphic construction finds clear i-f.....170 Dec  
 Harmer, J. D., Transistor beta tester.....212D Aug  
 Harris, E. F., Decoupling between microwave antennas.....204D June  
 Harzard, L., Mark-sensing cards aid quality control on tcan assembly lines.....232D Feb  
 Hatcher, R. D., Tompkins, Reggia & Spencer, Ferrite-rod antennas operate in X-band.....159 Jan  
 Hayward, R. K., Bubb & Fensom, Computer selects premium bond winners.....138 July  
 Heintz, R. M., Video recorder trains radar observers.....146 Sept  
 Heller, G. & Rottgardt, Rectangular dark-trace tube.....208D June  
 Hendrick, Jr., R. W., Martin and Chapman, Measuring Corona from radioactive point.....172 Mar  
 Hendrick, Jr., R. W., Measuring parameters of junction transistors.....174 Aug  
 Herr, R. & Casement, Coated-filler resin speeds encapsulation.....258D Aug  
 Hingston, A. J. & Santelmann, Jr., Long scope probes using passive elements.....206D Sept  
 Hoffman, M. & Isaacson, Electronic printer for etched slot antennas.....238D July  
 Hofheimer, R. W., Extend output with regulated flip flop.....182D Dec  
 Hoge, H. H. & Spotten, Transistorized afc uses triangular search sweep.....178 Nov  
 Hollis, J. L., Collins and Schmidt, Radio transmitter for ionospheric scatter.....144 June  
 Homer, E. G., Silicon transistor crystal oscillators have high temperature stability.....218D Oct  
 Hopkins, E. G. & Fraser, Thyratrons stabilize induction heaters.....152 July  
 Horner, S. G. L., Crosby & Coffman, Single sideband links Canadian traders.....174 Oct  
 Horstman, C. C. & Roberts, Core tester simplifies ferro-amplifier design.....150 Aug  
 Humfield, J. B., Fluid-cooling an airborne transmitter.....170 July  
 Hurtig, C. R., Sensory aid defines lights and marks.....162 Feb

**I**

Ives, R. L., Dual-triode tester measures tube balance.....194 Mar  
 Ives, R. L., Music pulse analyzer rejects voice signals.....183 Apr  
 Ives, R. L., Time-signal broadcast sets electric clock.....174 July  
 Isaacs, G. W., Solar powered electric fence charger.....188D Dec  
 Isaacson, S. & Hoffman, Electronic printer for etched slot antennas.....238D July

**J**

Jackson, J. M. & Suran, Gamma-ray monitor has high reliability.....170 Nov  
 Jacob, M. L., Reference generator for SSB systems.....162 Feb  
 Jacobsen, A. E. & Tinsley, Test equipment for transistor production.....148 Oct  
 Johanson, N. L., Demodulator-limiter for control system signals.....155 Sept

**K**

Kearse, G. P., Sleeve radiator for tv reception.....208D Mar  
 Kennedy, R. C., Simultaneous color-tv test signal.....146 May  
 Keonjian, E. & Suran, Unijunction transistor forms flip-flop.....165 Sept  
 Kerwin, W. J., Chronograph times supersonic models.....152 Apr  
 Ketchum, D. D., Frantz, Jr. & Walden, Buoy telemeters ocean temperature data.....164 June  
 Kiebertz, R. B., High-temperature subassembly design.....168 May  
 Kihara, Y., Kinoshita, Fujimura & Mii, Transistors synchronize portable tv camera.....168 July  
 King, R. E. & Strassman, Counters select magnetic drum sectors.....161 Apr  
 Kinoshita, K., Fujimura, Kihara & Mii, Transistors synchronize portable tv camera.....168 July  
 Kirkpatrick, C. H. & Wulfsberg, Dual purpose circuitry cuts transceiver size.....134 Dec  
 Knight, S., Transistorized guidance system feeds chickens.....156 Feb  
 Kohl, D. A., Logarithmic amplifier has 50-db range.....214D Jan  
 Kojima, H. & Fujii, R-f power supply for infrared viewers.....163 Nov  
 Konigsberg, R. L., Operational bridge gages high capacitance.....175 Jan  
 Kopp, A. R., Compliance meter tests phono cartridges.....206 Oct  
 Kretzman, B. H., Fork-driven dual tone standard.....196D Feb  
 Kushner, D., Gate tube generates interleaved pulse chain.....186 Apr

**L**

Lambourne, E. W., Automatic level control for tv slide chains.....182 July  
 Lee, R. H., Solar-flare detection for IGY.....162 Mar  
 Leib, K. & Ritchey, High speed strobe checks tube vibrations.....224D Feb  
 Levin, H. L., Coaxial line impedance chart.....190 Nov  
 Lewis, F. M. & Rader, Field direction oscillator.....208D Feb  
 Lindgren, L. & Osborn, Blank cards serve as printed circuit breadboards.....234D Nov  
 Logue, S. H., Rate-of-climb meter uses doppler radar.....150 June

**M**

Macpherson, A. C., Magic tee technique.....230D Nov  
 Maitland, W. D. & Sutherland, Air shipment pack for large magnets.....236D June  
 Manoogian, H. A., Simple sync circuits time itv systems.....174 Mar  
 Mansberg, H. P., Yamagami & Berkeley, Spot scanner counts micron-sized particles.....142 Dec  
 Markus, J., Mechanized production of tv wiring boards.....138 Apr  
 Martin, F. C., Chapman & Hendrick, Measuring corona from radioactive points.....172 Mar  
 Martin, R. E. & Meth, Interelectrode capacitance tester.....220D Apr  
 Massa, E. A. & Massa, Pen motor for rectilinear recording.....159 Feb  
 Massa, F. & Massa, Pen motor for rectilinear recording.....159 Feb  
 Mate, H., Color tv system uses flying-spot scan.....138 Feb

Mathis, H. F., L-network design.....186 Feb  
 Mathis, H. F., Transmission line impedance measurement.....186 June  
 McFarlane, H. B., Pulse attenuators for cro displays.....218D Aug  
 McKinley, D. W. R. & Richards, Transistor amplifier for medical recording.....161 Aug  
 McKinley, D. W. R., Transistor relays have low idling current.....147 Dec  
 McMichael, B. D. & Costello, Large shielded enclosure.....236D Aug  
 Meagher, R. J., Automatic taper for vacuum-tube testing.....260D Feb  
 Mercurio, Jr., S. P. & Belby, Designing airborne equipment for vibration.....166 Jan  
 Merson, L. N., Conductor size and spacing for printed circuits.....178D Dec  
 Merson, L. N., Transistors boost video for tv studio monitors.....205 Oct  
 Meth, I. & Martin, Interelectrode capacitance tester.....220D Apr  
 Migliaro, E. J., Designing tapered waveguide transistors.....183 Nov  
 Mii, N., Kinoshita, Fujimura & Kihara, Transistors synchronize portable tv camera.....168 July  
 Miller, E. C., Automatic programming in small a-m stations.....146 Feb  
 Mitchum, M. M., Broadcast modulation monitor.....200D July  
 Montgomery, F. G. & Stansbury, Clamp-on microammeter measures a-c current.....152 Dec  
 Montgomery, G. F., Transistor beta tester.....198D May  
 Montgomery, L. H., Muscles control iron-lung operation.....180 July  
 Morgan, H. L., Designing electronics to resist nuclear energy.....155 May  
 Morgan, J. M., Pike, Gray & Flory, Miniature itv camera uses drift transistors.....138 Jan  
 Morgan, J. M., Pike, Flory & Gray, Portable tv station for remote pickups.....170 Feb  
 Morris, A. J. & Swanson, Tones monitor heart's electrical action.....160 Nov  
 Myers, G. H., Diode-clamp nomograph.....188 Sept

**N**

Nail, C. D., Focusing oscilloscope cameras.....192D Sept  
 Newitt, W., Preamplifier for ceramic pickups.....200D Aug  
 Nilsen, O. K., Schlegelmilch & Pan, Antenna-multiplex system design.....148 July  
 Novak, E. K., Telemetering system is balloon borne.....158 Sept

**O**

Oelbermann, E. J., Video scanner matches photo patterns.....154 Aug  
 O'Kelley, H. E. & Todd, Magnetically deflected 21-inch oscilloscope.....159 July  
 Olson, A. E., Mobile communications impulse signaling.....214D Feb  
 OrNSTEIN, W., Thyratrons cost rotary selector in mobile phone.....150 Nov  
 Orr, L. W., Demonstration neon multivibrator.....198D June  
 Osborn, A. & Lindgreen, Blank cards serve as printed circuit breadboards.....234D Nov  
 Osborn, W. E., Airborne infrared warning system measures range.....190D July  
 Osborn, W. E., Infrared detector aids medical diagnosis.....155 Oct  
 Owen, K., Ellis & Weatherup, Transmitter tuned by distortion indicator.....180 Sept

**P**

Palmer, J. E. & Propster, Jr., Puncher transcribes computer output.....164 Dec  
 Palmisano, R. R. and Sherman, Waveguide bender uses shockspring-steel mandrel.....226D May  
 Pan, W. Y., Schlegelmilch & Nilsen, Antenna-multiplex system design.....148 July  
 Papian, W. N., High-speed computer stores 2.5 megabits.....162 Oct

Park, Jr., J. H. & Gott, Transistors generate geometric scale. 180 Jan  
 Patraiko, J. Transistorized strobe measures shaft torque. 147 June  
 Peay, P. W. Horsepower nomograph for radar antenna rotators. 188 Jan  
 Pederson, C. W. Crystal clock for airborne computer. 196D June  
 Peterson, E. K., Ulander, Hargis & Hajic, Microwave remotes aid air traffic control. 144 July  
 Pfund, Jr., E. T., Distributed amplifiers as antenna multicouplers. 176 Apr  
 Philipps, L. E., Selective a-f induction signaling. 180 June  
 Pierson, H. O., Choosing materials for heat-resistant radomes. 256D Nov  
 Pihl, G. E., Phase generator has resistive shifter. 175 Nov  
 Pike, W. S., Flory, Gray & Morgan, Miniature tv camera uses drift transistors. 138 Jan  
 Pike, W. S., Flory, Gray & Morgan, Portable tv station for remote pickups. 170 Feb  
 Pollard, P. J., Speed indicator has expanded scale. 188 May  
 Pomeroy, A. F., Waveguide loss charts. 210 Oct  
 Porter, J. H., Automatic pulse width control. 200D Apr  
 Porter, J. H., Missile telemeter uses transistor amplifier. 170 May  
 Prihar, Z., Reflection point and angle nomographs. 184 Jan  
 Propster, Jr., C. H. & Palmer, puncher transcribes computer output. 164 Dec  
 Proudfit, A., St. John, Wilhelmson & Farber, Tetrajunction transistor simplifies receiver design. 148 Apr  
 Putsch, H. N., Raper & Suran, Digital-analog converter provides storage. 148 Dec

**Q**

Quandt, R. L. & Sanders, Amplifier selectivity curves. 188 Aug

**R**

Rader, A. R. & Lewis, Field direction oscillator. 208D Feb  
 Raper, J. A., Putsch & Suran, Digital-analog converter provides storage. 148 Dec  
 Rashkow, B. R., Aircraft radiophone speeds communications. 164 Apr  
 Reed, H. E. & Altes, Slow-scan adapter for conventional tv signals. 153 June  
 Reggia, F., Spencer, Hatcher & Tompkins, Ferrite-rod antennas operate in X-band. 159 Jan  
 Riblet, H. B., Automatic data plotter for f-m/f-m telemetering. 182 Aug  
 Rich, A. L., Navigation trainer controls ship models. 172 Sept  
 Richards, R. S. & McKinley, Transistor amplifier for medical recording. 161 Aug  
 Riddle, R. L., How transistors operate under atomic radiation. 125 Dec  
 Ritchey, N. & Leib, High speed strobe checks tube vibrations. 224D Feb  
 Roberts, R. W. & Horstman, Core tester simplifies ferro-amplifier design. 150 Aug  
 Robinson, W. W., Precision spotwelder handles metal foils. 150 Feb  
 Rose, A. J., Plug-in toroid assembly techniques. 260D Mar  
 Rottgardt, K. H. J. & Heller, Rectangular dark-trace tube. 208D June  
 Rutherford, C. R., Instantaneous speech compressor. 168 Feb  
 Ryan, P. A., Tristable gate moves cro line drawings. 178 May

**S**

Sanders, J. & Quandt, Amplifier selectivity curves. 188 Aug  
 Santelmann, Jr., W. F. & Hingston, Long scope probes using passive elements. 206D Sept  
 Sarratt, E. R. & Abelew, Ship alarm uses computer techniques. 180 Feb  
 Savant, C. A. & Savant, Transistor transformer design nomographs. 204 Mar

Savant, C. J. & Savant, Transistor transformer design nomographs. 204 Mar  
 Scanza, W. A., Ridge vane antenna provides constant beamwidth. 196D Nov  
 Scarpa, T. J., Ultrasonic iron solders aluminum. 168 Oct  
 Scheib, Jr., R., Transistors stabilize missile ships. 138 June  
 Schlegelmilch, H. K., Nilssen & Pan, Antenna-multiplex system design. 148 July  
 Schmidt, A. R., Hollis & Collins, Radio transmitter for ionospheric scatter. 144 June  
 Schoyer, D. S., Fischer & Gerlach, Air-drop system broadcasts message. 179 Mar  
 Schreiber, W. F., Compact supplies have wide range regulation. 168 Dec  
 Schubring, N. W., Fitch & Weller, Counter circuits analyze ignition. 150 May  
 Schumacher, B. W., Leak detector for hermetic seals. 284D Mar  
 Schwartz, H. H., Driving simulator shows crash hazards. 192D June  
 Seism, W. A., Computer delay unit uses semiconductor. 173 July  
 Seism, W. A., Voltage regulator uses multivibrators. 184 Sept  
 Scott, Jr., T. R. & Wrigley, VHF rheostat. 196D Dec  
 Seals, R. B., Audio clipper extends coverage. 204D Feb  
 Shapiro, A., Film reader measures recorded radar echoes. 154 Jan  
 Sherman, A. & Palmisano, Waveguide bender uses clockspring-steel mandrel. 226D May  
 Shive, S. L., Lossy transmission line filter uses ferrites. 204D Apr  
 Shuster, N. J., New materials cut drafting costs for printed circuits. 252D Mar  
 Simonsen, O., Exact calibration from a standard. 194D Sept  
 Smith, K. D., Silicon diodes protect meters. 224D Oct  
 Smith, M. R., Trefethen & Dudley, Ultrasonic tracer follows tagged fish. 156 Apr  
 Smith-Vaniz, W. R. & Barrett, Morse-to-teletypewriter code converter. 154 July  
 Snodgrass, J. M. & Cawley, Jr., Bathythermometer telemeters ocean data. 142 May  
 Snyder, R. H., Video tape recorder uses revolving heads. 138 Aug  
 Spencer, E. G., Hatcher, Tompkins & Reggia, Ferrite-rod antennas operate in X-band. 159 Jan  
 Spullen, D. L. & Hoke, Transistorized safe uses triangular search sweep. 178 Nov  
 Spracklen, J., Adler & Desmares, Ultrasonic gong controls tv sets. 156 Mar  
 Spracklen, J., Stroh & Wood, Noise gating tube for age and sync. 172 May  
 St. John, K. M., Wilhelmson, Farber & Proudfit, Tetrajunction transistor simplifies receiver design. 148 Apr  
 Stachiewicz, B. R., Rural carrier system uses transistors. 146 Aug  
 Stansbury, C. & Montgomery, Clamp on microammeter measures a-c current. 152 Dec  
 Stephenson, D. L. & Brooks, Strain gage system for aircraft telemetering. 170 Oct  
 Strassman, A. J. & King, Counters select magnetic drum sectors. 161 Apr  
 Stroh, W. J., Wood & Spracklen, Noise gating tube for age and sync. 172 May  
 Sullivan, A. W. & Wells, Probability computer for noise measurement. 208 Oct  
 Suran, J. J. & Jackson, Gamma-ray monitor has high reliability. 170 Nov  
 Suran, J. J. & Keonjian, Unijunction transistor forms flip-flop. 165 Sept  
 Suran, J. J., Raper & Putsch, Digital-analog converter provides storage. 148 Dec  
 Sutherland, N. V. & Maitland, Air shipment rack for large magnetrons. 236D June  
 Swanson, J. P. & Morris, Tones monitor heart's electrical action. 160 Nov  
 Sylvan, T. P., Conversion formulas for hybrid parameters. 188 Apr

**T**

Tarui, Y., Transistor complementary symmetry. 200D Sept  
 Thompson, F. T., Sync generator for dot-interlace tv. 170 Aug  
 Tinsley, C. G. & Jacobsen, Test equipment for transistor production. 148 Oct  
 Todd, C. D., Metal detector finds ducts and pipes. 172 Jan  
 Todd, C. D., Transistor null detector has high sensitivity. 184 Feb  
 Todd, W. H. & O'Kelley, Magnetically deflected 21-inch oscilloscope. 159 July  
 Tombs, D. M., Chatterton & Galpin, Applications of corona effects. 198D July  
 Tompkins, J. E., Reggia, Spencer & Hatcher, Ferrite-rod antennas operate in X-band. 159 Jan  
 Trefethen, P. S., Dudley & Smith, Ultrasonic tracer follows tagged fish. 156 Apr  
 Treves, D. & Frei, Clip-on milliammeter uses magnetic amplifiers. 204D Jan

**U**

Ulander, H. R., Peterson, Hargis & Hajic, Microwave remotes aid air traffic control. 144 July  
 Unterberger, R. R., Pulsed f-m tests ultrasonic propagation. 143 Jan

**W**

Walden, R. G., Ketchum and Frantz, Jr., Buoy telemeters ocean temperature data. 164 June  
 Wallace, J. E. & Zehner, Rectifier locomotive. 220D Mar  
 Wallmark, J. T., Photocell measures light direction. 165 July  
 Ware, L. & Fallon, Ultrasonic welding joins foil to wires. 216D Dec  
 Warren, F. & Corden, Ground-controlled drone tests missiles. 182 Mar  
 Weatherup, G. R., Ellis & Owen, Transmitter tuned by distortion indicator. 180 Sept  
 Webster, R. R. & Carroll, Magnetic field pickup follows buried cables. 156 Sept  
 Weil, P. A., Wide-swing choke. 202D July  
 Weissman, J. G., Sweep testing thyra-tron characteristics. 206D Dec  
 Weller, Jr., E. R., Schubring & Fitch, Counter circuits analyze ignition. 150 May  
 Wells, J. D., Logarithmic amplifier measures noise. 169 Apr  
 Wells, J. D. & Sullivan, Probability computer for noise measurement. 208 Oct  
 Wenner, R. G., Electronic crowbar protects transmitter. 174 June  
 Werb, Jr., J. A., 3-D packaging for circuits. 244D Nov  
 Wheeler, A. J., Thermistors compensate transistor amplifiers. 169 Jan  
 Whitaker, J. N., Magnetic tape controls projector synchronism. 143 Sept  
 White, D. R. J., Charts simplify passive d-c filter design. 160 Dec  
 Wilhelmson, C. K., Farber, Proudfit & St. John, Tetrajunction transistor simplifies receiver design. 148 Apr  
 Wilner, J. T., Motion minimizes image orthicon burn-in. 180 Aug  
 Wirth, H. J., Cascode auto preamplifier. 234D Oct  
 Wise, W. L. & Bequert, Universal etched circuit for plug-in units. 230D June  
 Witt, Jr., S. N., Designing oscillators for greater stability. 180 Nov  
 Wolfe, B., Single-carrier system for sound and video. 151 Jan  
 Wood, G. C., Spracklen & Stroh, Noise gating tube for age and sync. 172 May  
 Wray, P. G., Transistorized multiplex radio-teletypewriter. 150 Sept  
 Wrigley, W. B. & Scott, Jr., VHF rheostat. 196D Dec  
 Wuifsborg, P. C. & Kirkpatrick, Dual purpose circuitry cuts transceiver size. 134 Dec  
 Wyeth, P. H., Davis & Alden, Precise heat for growing silicon crystals. 164 Feb

**Y**

Yamagami, Y., Mansberg & Berkley, Spot scanner counts micron-sized particles. 142 Dec  
 Young, C. W., Helical scan nomograph. 186 July  
 Young, L., Coaxial stub design. 188 July

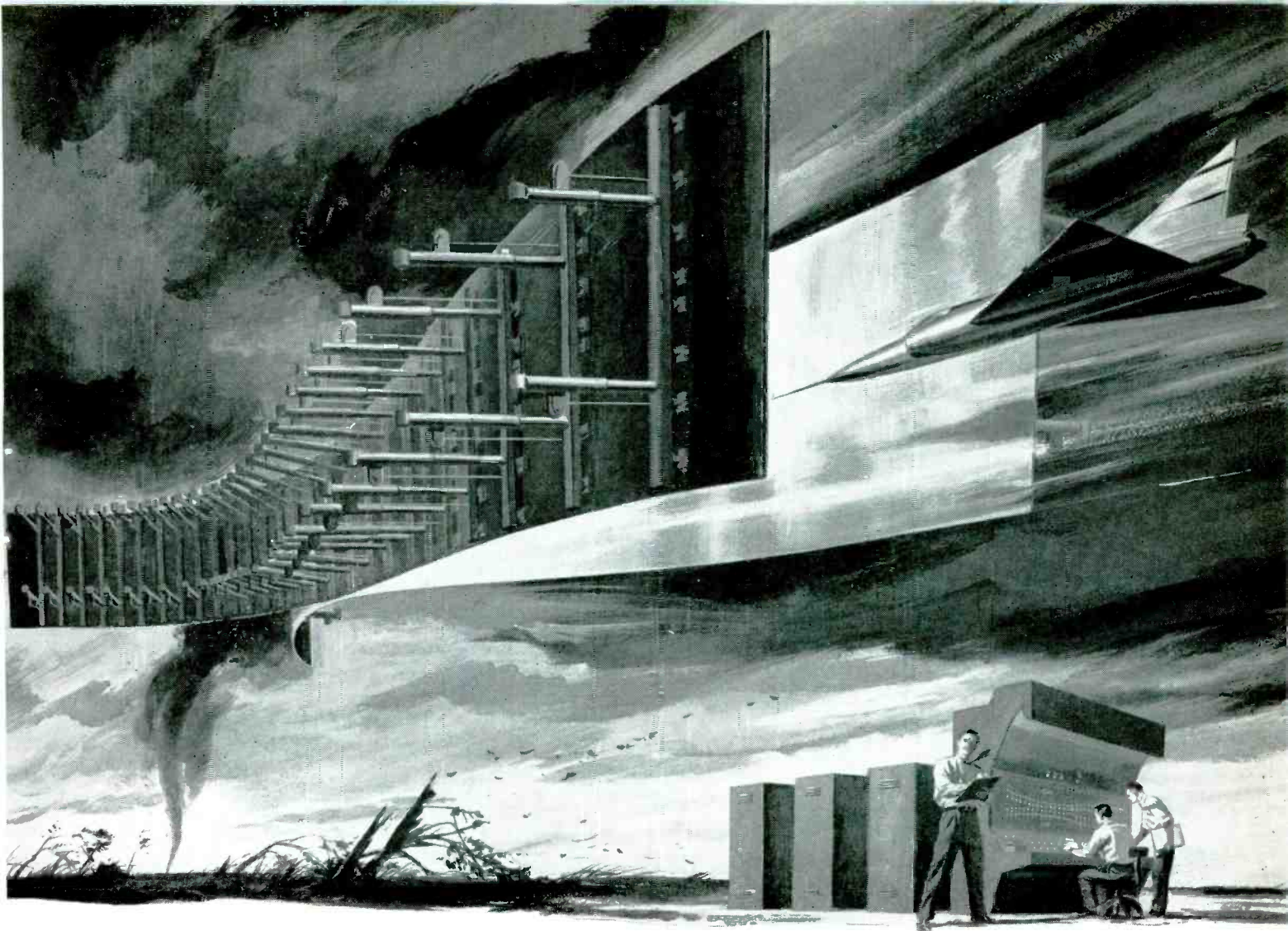

## Putting the screws on a tornado

The supersonic wind tunnel under construction at Tullahoma, Tennessee, combines some of the most gigantic construction with some of the most precise electronic controls in the whole history of aircraft testing.

The project simulates conditions of flight in excess of 16 miles altitude, from Mach 1.5 to approximately Mach 4.5. Some of the statistics of design are startling, even in today's world of wonders.

The nozzle walls of the tunnel are solid steel, 100 feet long, 16 feet high. To reach any one of 300 master positions, these plates are moved by 56 huge screw jacks on each side—with a tolerance for error restricted to 8 one-thousandths of an inch in an 8-foot stroke! Each jack "talks back" electronically to Master Control, reporting its position. Provision is made for remote starting and operation by magnetic tape programming, set up in advance.

Two associated companies are doing this job—the Electric Boat and Stromberg-Carlson divisions of General Dynamics Corporation. Electric Boat—

builders of the atomic-powered submarines, *Nautilus*, *Seawolf* and *Skate*—has overall responsibility, will supply the jacks and design the servo mechanisms. Stromberg-Carlson is to create and build the digital computer system for the electronic controls.

This project—combining heavy, giant-size, accurate "machinery" with electronic systems of a complex, automated nature—is typical of the service which General Dynamics divisions offer.

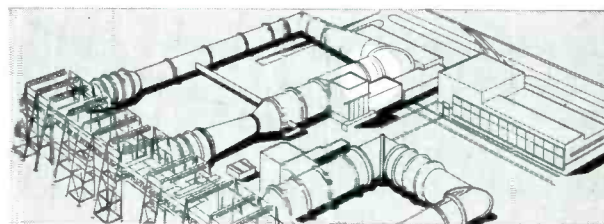

Sketch of the project, being built by the U.S. Army Engineers for the U.S. Air Force, Arnold Engineering Development Center. Circled area locates the special walls and nozzle.



**STROMBERG-CARLSON**  
A DIVISION OF GENERAL DYNAMICS CORPORATION

General Offices and Factories at Rochester, N. Y.—West Coast plants at San Diego and Los Angeles, Calif.



CIRCLE 156 READERS SERVICE CARD

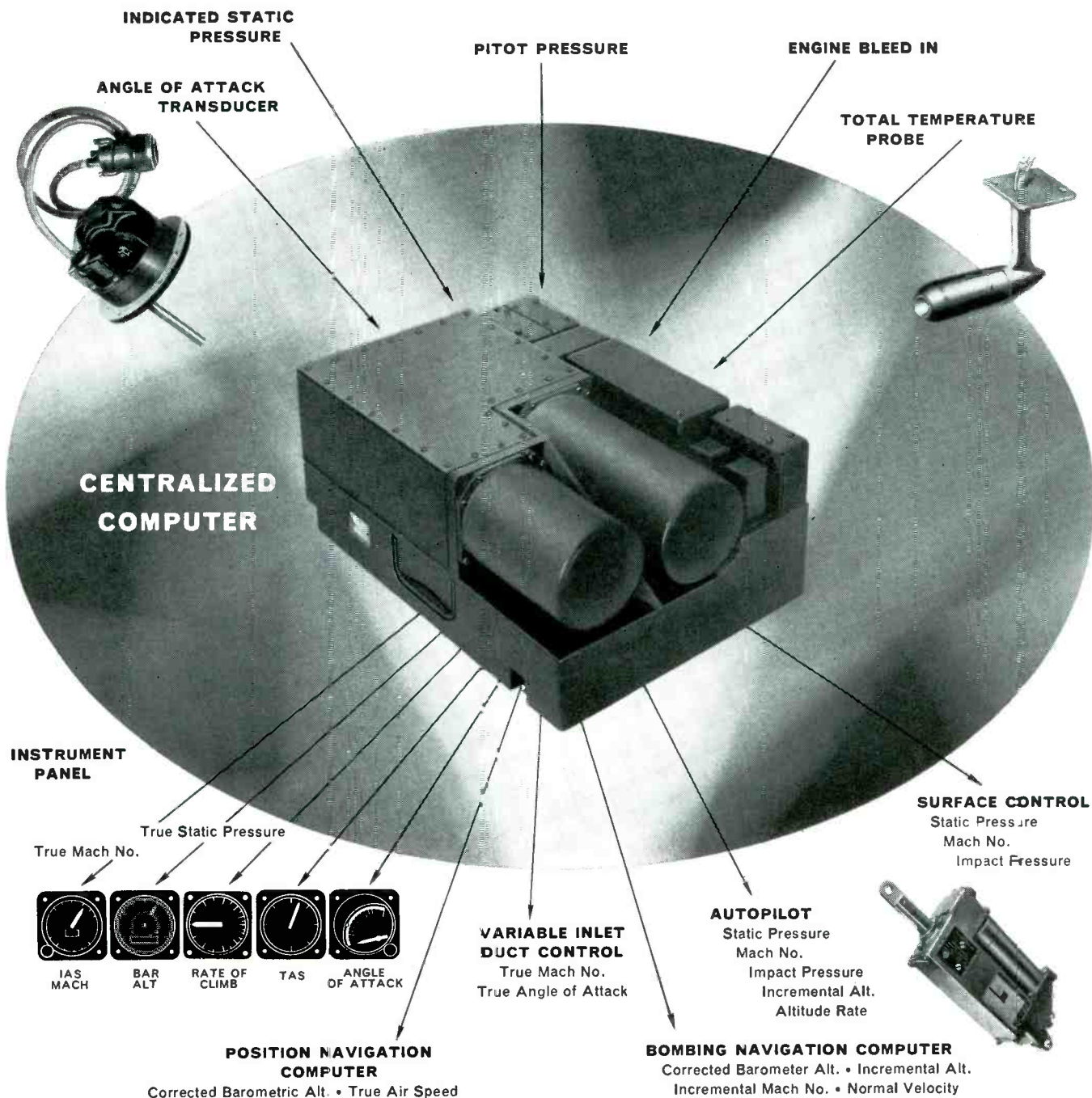

All illustrated components are designed, developed and manufactured by AiResearch

# Centralized Air Data System

This AiResearch computer system eliminates duplication of components, cutting down space and weight requirements over decentralized systems by many times. It can cover a wide area of functions while meeting the most rigid specifications in regard to

accuracy and dependability. Since the great majority of its components are AiResearch products, both compatibility and reliability are assured.

We are prepared to assume overall responsibility for systems or sub-systems.

• Outstanding opportunities for qualified engineers



**THE GARRETT CORPORATION**

**AiResearch Manufacturing Divisions**

Los Angeles 45, California . . . Phoenix, Arizona

Designers and manufacturers of aircraft and missile systems and components: REFRIGERATION SYSTEMS • PNEUMATIC VALVES AND CONTROLS • TEMPERATURE CONTROLS  
CABIN AIR COMPRESSORS • TURBINE MOTORS • GAS TURBINE ENGINES • CABIN PRESSURE CONTROLS • HEAT TRANSFER EQUIPMENT • ELECTRO-MECHANICAL EQUIPMENT • ELECTRONIC COMPUTERS AND CONTROLS

# TO CONQUER PROBLEMS OF "INNER" SPACE

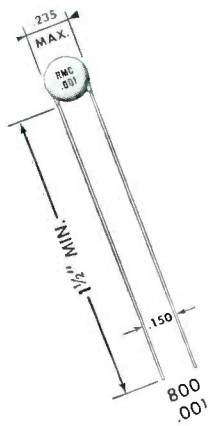

Actual Size

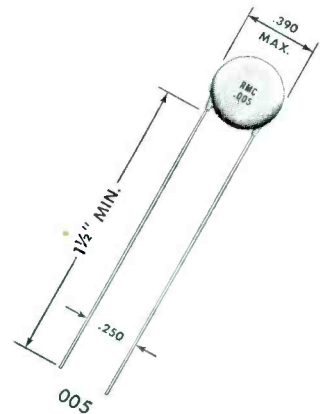
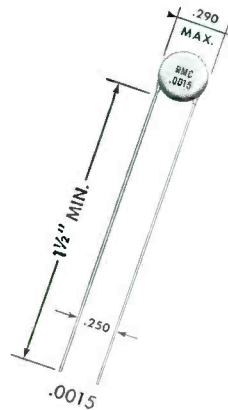

UB

Another RMC first  
Type

# SM

# MINIATURE DISCAPS

## SPECIFICATIONS

- POWER FACTOR:** 1.5% Max. @ 1 KC (initial)
- WORKING VOLTAGE:** 500 V.D.C.
- TEST VOLTAGE:** (FLASH): 1000 V.D.C.
- LEADS:** No. 22 tinned copper (.026 dia.)
- INSULATION:** Durez phenolic (1/8" max. on leads)  
— vacuum waxed
- STAMPING:** RMC—Capacity—Z5U
- INITIAL LEAKAGE RESISTANCE:** Guaranteed  
higher than 7500 megohms.
- AFTER HUMIDITY LEAKAGE RESISTANCE:**  
Guaranteed higher than 1000 megohms.

Designers who need true miniaturization in a ceramic capacitor can now specify RMC's new Type SM DISCAPS with assurance of the quality and dependability that is built in all RMC DISCAPS without sacrificing performance of electrical characteristics.

Type SM DISCAPS meet or exceed the RETMA REC-107-A specifications for Z5U ceramic capacitors. They are available in values of 800, .001, .0015 GMV and .005 ± 20%.

An entirely new ceramic dielectric provides a high safety factor with steady or intermittent voltage. Type SM DISCAPS show minimum capacity change between + 10° C and + 65° C.

Write on your letterhead for samples and performance data.

DISCAP  
CERAMIC  
CAPACITORS



**RADIO MATERIALS CORPORATION**  
 GENERAL OFFICE: 3325 N. California Ave., Chicago 18, Ill.  
 Two RMC Plants Devoted Exclusively to Ceramic Capacitors  
 FACTORIES AT CHICAGO, ILL. AND ATTICA, IND.

# During 1958 your SELLS ALL DESIGN/PRODUCTION ...key buyers among manufacturers



## SELECTED CIRCULATION x Editorial Coverage = Increased Readership

### HOW DOES OUR INDUSTRY BUY?

New facts uncovered by a recently completed McGraw-Hill industry survey prove . . . *THREE* individual groups influence the purchasing of nearly \$7 billion worth of electronics goods and services. These groups can be readily defined by their job functions: design, production, management . . . yet they exhibit one community interest: intense readership of **electronics**.

In the light of these facts can you expect to sell the entire industry by reaching only *one* group of people? Obviously not!

When in the marketing process the buying influence for a component, an instrument, a piece of hardware, or an entire system is presumed to exist largely or entirely in **LESS THAN ALL OF THE AREAS** of DESIGN-PRODUCTION-MANAGEMENT, oversimplification may very well have taken place. The natural urge of

the market analyst in the electronic field is to overrefine and present too simple, too easy a solution. In other words across-the-board readership of **electronics** is necessary for the successful marketing of electronic products.

This is why **electronics** new weekly publishing plan is so important to you. Starting January 3rd, 1958, **electronics** will publish alternate Business and Engineering Editions fulfilling subscribers' needs for increased amounts of *interpreted* information. As a measure of acceptance, paid subscribers will reach an all-time high in 1958 . . . 52,000!

Simplify your media problems, pick the *one* publication that penetrates *deeply* into all three purchasing levels: design, production, management . . . pick **electronics**!

Learn all the facts, send for the following: **electronics** BECOMES A WEEKLY IN 1958; new 52-time Rate Card and Publishing Cycle Chart . . . or see your local representative *in person!*

Only **electronics** SELLS ALL 3

During 1958 REACH 52,000 Subscribers



# electronics advertising...

# THREE

# /MANAGEMENT

## and users of electronic equipment

### electronics is vital to your sales program

- electronics offers the most complete editorial service . . . 26 Engineering Editions — 26 Business Editions — PLUS the Buyers' Guide . . . 53 effective ways to sell the market! (See Printers' Ink Centerspread, December 6, 1957.)
- electronics will deliver increased readership every week. (See Printers' Ink Centerspread, September 27, 1957.)
- electronics spans its industry . . . reaching 52,000 paid subscribers. (See Printers' Ink Centerspread, October 11, 1957.)

## 52

**Weekly Issues—  
Alternate**

**Engineering and Business  
Editions  
plus the mid-year  
Buyers' Guide**

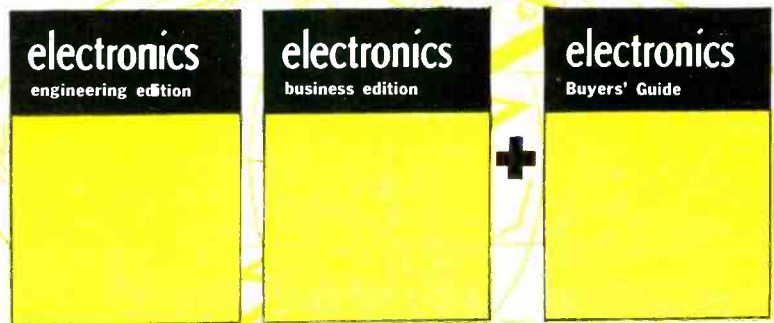

A MCGRAW-HILL PUBLICATION  
330 W. 42nd Street, New York 36, N. Y.



## DESIGN / PRODUCTION / MANAGEMENT

### Every Week...in electronics, of course!





60,000 WESTINGHOUSE

***and not one***



RECTIFIERS INSTALLED FOR ONE CUSTOMER

## ***case of field failure***

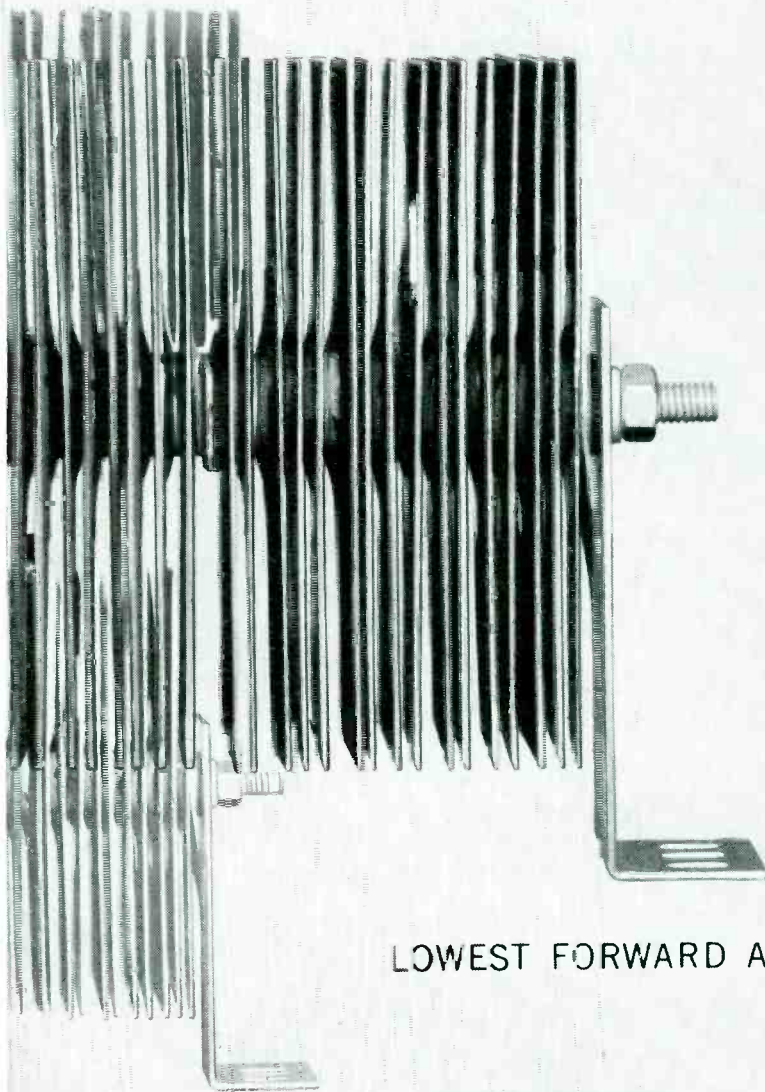

The selenium rectifier stacks furnished for one Westinghouse customer have proved so successful in world-wide installations that they have standardized on Westinghouse units. In over three years, not one Westinghouse unit has been a field failure—or caused a failure of operation.

Extensive life tests prove that in 20,000 continuous hours of service, the change in forward voltage drop of Westinghouse rectifier cells is less than 5 percent. Reverse leakage actually decreases with use. This superior performance . . . with up to 90 percent conversion efficiency . . . is assured by the vacuum evaporation deposit process and carefully controlled manufacturing conditions in making Westinghouse selenium cells.

For complete design and application information, call your Westinghouse sales engineer. Or write Westinghouse Electric Corporation, P. O. Box 868, 3 Gateway Center, Pittsburgh 30, Pa.

J-22070

LOWEST FORWARD AGING RATE IN THE INDUSTRY

YOU CAN BE SURE...IF IT'S

# Westinghouse

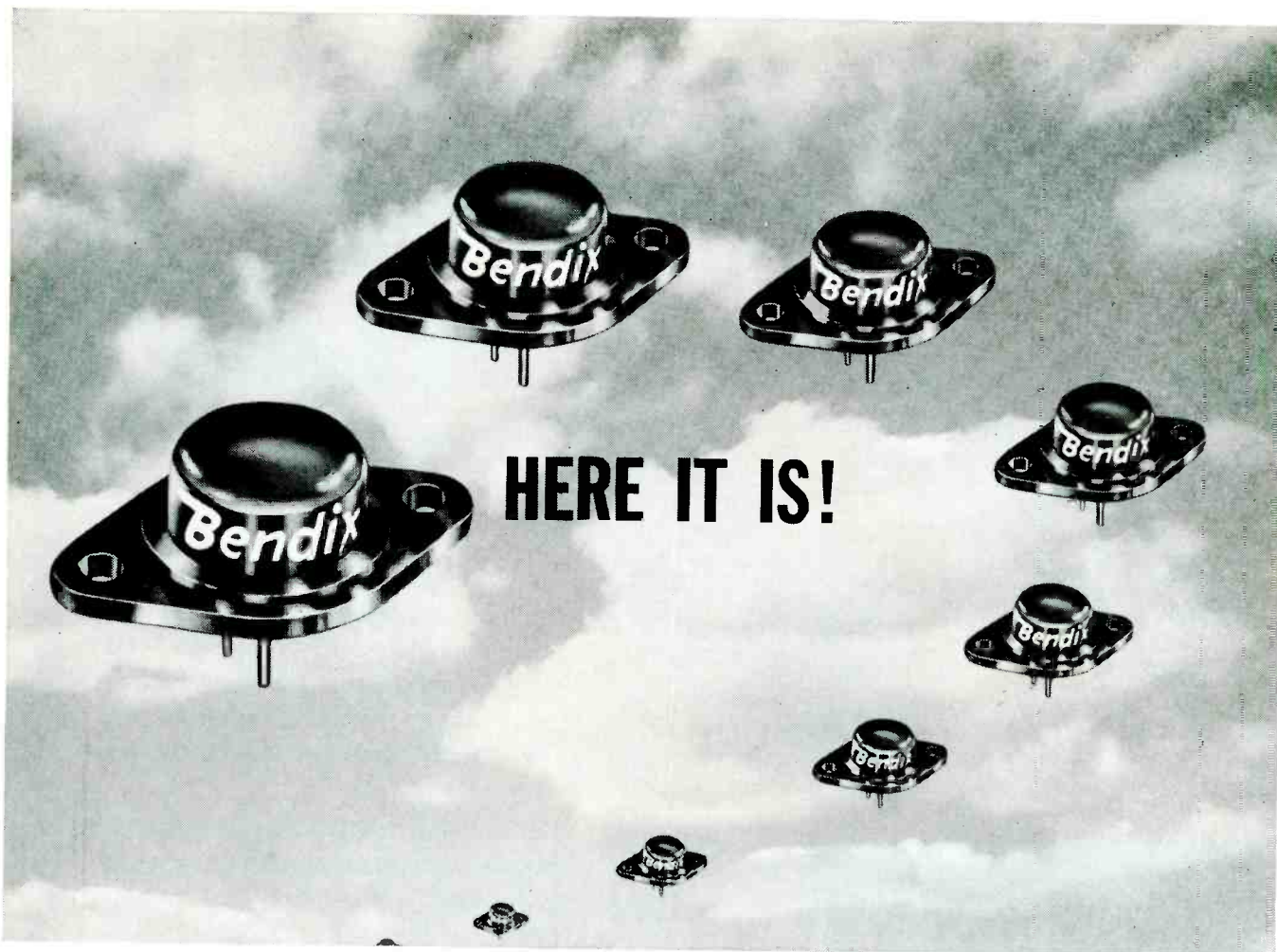

**HERE IT IS!**

## BENDIX 2N285A — THE HIGHEST GAIN POWER TRANSISTOR ON THE MARKET

The 2N285A is a good example of how you get extra quality at no extra cost when you specify *Bendix* transistors.

Not only are Bendix transistors favored for their high power and gain, but also for their low leakage, life stability, high breakdown voltage, low thermal resistance, and linear temperature variation.

There is a wide variety of Bendix power transistors. And, since we are in volume production, we can offer immediate delivery on most models. For full details, or for help with circuitry problems, write SEMICONDUCTOR PRODUCTS, BENDIX AVIATION CORPORATION, LONG BRANCH, NEW JERSEY.

West Coast Sales and Service: 117 E. Providencia Ave., Burbank, Calif.  
Canadian Affiliate: Computing Devices of Canada, Ltd., P. O. Box 508,  
Ottawa 4, Ont.  
Export Sales & Service: Bendix International, 205 E. 42nd St., New York 17, N. Y.

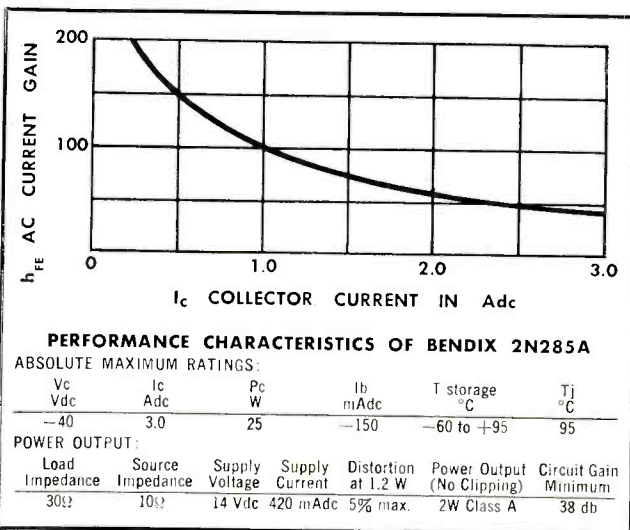

Red Bank Division



# 50 ohm Coax Terminations dc to 4 KMC!



## WIDEBAND DIRECTIONAL COUPLERS

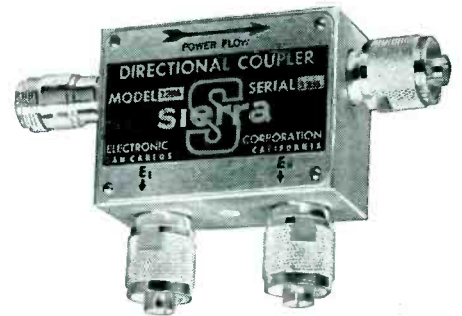

## 8 new instruments! 1 to 500 watts coverage!

Versatile, accurate Sierra couplers are offered in 6 models for frequencies 10 kc to 2000 mc. Couplers provide transmission line measurements including reflection coefficient, VSWR, power. Also permit matching of loads to lines dynamically by indicating conditions providing minimization of reflected voltages. Request Bulletins 101, 104.

New Sierra 160 series Coaxial Terminations are ideal for use with directional couplers, or in other applications requiring wide frequency range and low VSWR. They provide extremely high stability, and will dissipate full rated power continuously up to an ambient temperature of 40°C. Derating permits operating at still greater ambient temperatures. Terminations are completely shielded, and may be used to adjust transmitters without radiation. They are also useful for converting Sierra Bi-Directional Power Monitors to a termination type wattmeter.

### SPECIFICATIONS

Model	Power*	Connectors	VSWR
160-1F	1 watt	Type N fem.	Less than 1.06, dc to 2 KMC; less than 1.08, dc to 4 KMC.
160-1M	1 watt	Type N male	
160-5F	5 watts	Type N fem.	Less than 1.08, dc to 4 KMC.
160-5M	5 watts	Type N male	
160-20F	20 watts	Type N fem.	Less than 1.08, dc to 1 KMC; less than 1.15, dc to 4 KMC.
160-20M	20 watts	Type N male	
160-100F	100 watts	Type N fem.	Less than 1.2, dc to 3300 MC.
160-500F	500 watts	Type N fem.	

\*Up to 40° C ambient.

Coupling Factor: (in db ± 1 db)

Model	10 kc	3 mc	10 mc	30 mc	100 mc	300 mc	1000 mc	2000 mc
137, 137A				73	63	53	43	37
138, 138A				59	49	39	29	
145		52	42	32	22	12		
150				53	43	33	23	
139	50	50						

Directivity: 12 db ± 3 db greater than coupling factor at each frequency.

Impedance: Models 137 and 138 are 51.5 ohms. Models 137A, 138A, 145 and 150 are 50.0 ohms. Model 139 may be matched to most impedances.

Power: Usable to 1000 watts throughout frequency range.

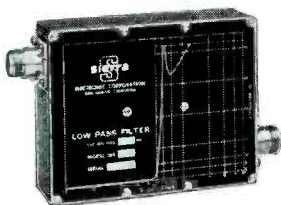

### New LOW PASS FILTERS

Sierra 184 series Low Pass Filters have an insertion loss not more than 0.4 db in pass band, sharp cut-off, 1.5 VSWR or less, and rejection greater than 60 db from 1.25 to 10 times cut-off frequency. Five models: for cut-off frequencies of 44, 76, 135, 230, 400 MC. Power range 250 watts in pass band, 25 watts in rejection band.

Write for Bulletin!



### SIERRA 148 CRYSTAL DETECTOR

Insures sensitive readout for Sierra Directional Couplers. Low VSWR, high sensitivity to 1200 MC. 50 ohm input impedance, filtered output. Type N input, BNC output connectors.



## Sierra Electronic Corporation

A Subsidiary of Philco Corporation

3885 Bohannon Dr., Davenport 6-2060, Menlo Park, Cal., U.S.A.

Sales Representatives in major cities

CANADA: Atlas Radio Corp., Ltd., Toronto, Montreal, Vancouver, Winnipeg

EXPORT: Frazar & Hansen, Ltd., San Francisco, New York, Los Angeles

Data subject to change without notice

3663-1

# NOW! 4 new microwave sweep oscillators

*speed, simplify  
measurements  
3.95 to 18.0 KMC*

Covers full band, or any part  
Use with 'scope or recorder  
All electronic; no mechanical sweep  
Direct reading, independently  
adjustable sweep range  
and rate controls

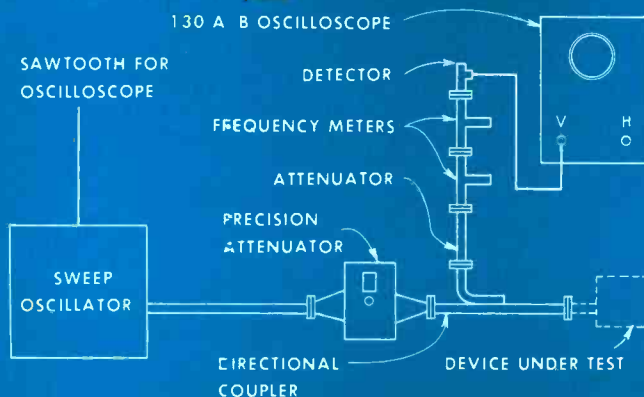
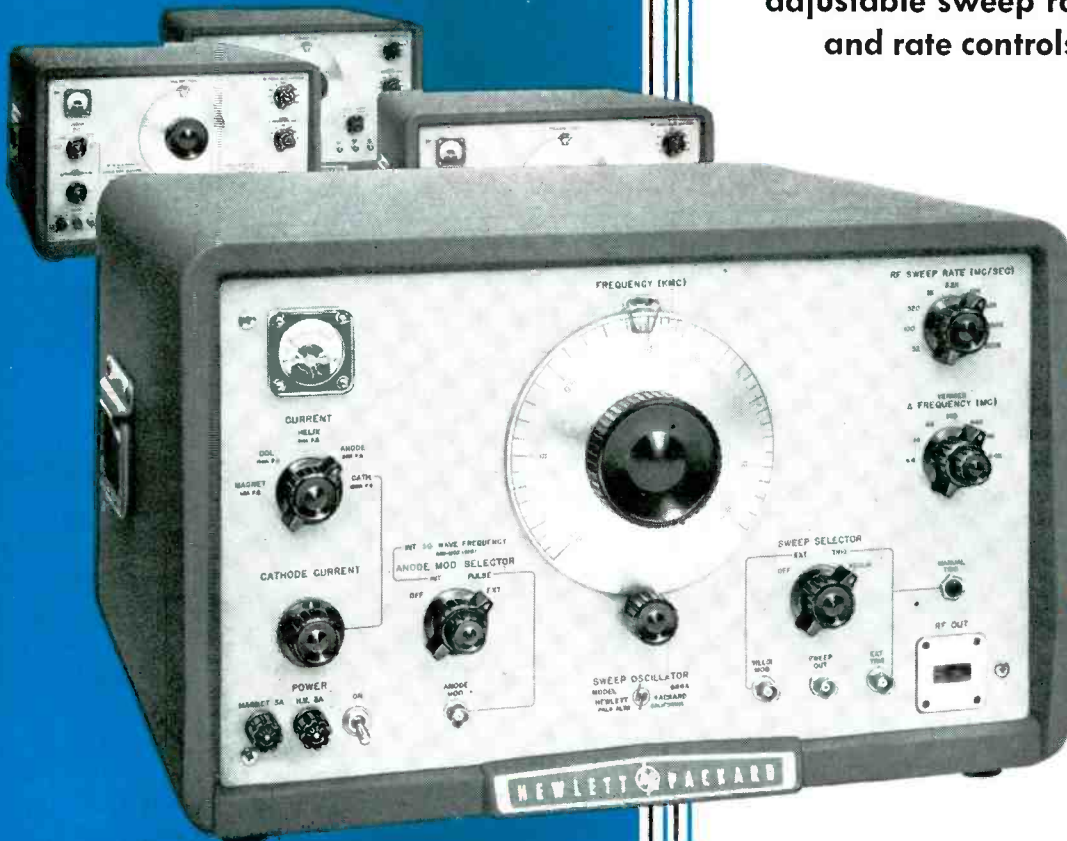

◀ Figure 1. Arrangement for high speed microwave measurement to provide rapid visual display with -hp- 130A/B oscilloscope. Can be used for G, J, X and P bands.

 Dependable, quality

Hewlett-Packard 684 series Sweep Oscillators are new measuring tools deliberately designed to give you simpler, faster microwave measurements. Four models are provided, covering the G band (3.95 to 5.85 KMC), J band (5.30 to 8.20 KMC), X band (8.20 to 12.40 KMC) and P band (12.40 to 18.00 KMC).

These new instruments make possible microwave investigations and evaluations with a convenience previously associated only with lower frequency measurements. The 684 series oscillators provide a wide range of sweep speeds so that measurements of reflection, attenuation, gain etc., can be displayed on an oscilloscope or recorded in permanent form on X-Y or strip-chart recorders.

### Electronic Sweeping

Specifically, the new oscillators provide either a CW or swept rf output throughout their individual bands. The instruments employ new backward wave oscillator tubes whose frequency is shifted by varying an applied potential. Thus, troublesome mechanical stops and tuning plungers are eliminated. Sweep range is continuously adjustable and independently variable; sweep rate is selected separately, and either can be changed without interrupting operation. The full band width can be covered in time segments ranging from 140 seconds (very slow for mechanical recorder operation) to 0.014 seconds (high speed for clear, non-flickering oscilloscope presentation).

### Linear Frequency Change

The swept rf output from the 684 series oscillator is linear with time, and a linear sawtooth voltage is provided concurrent with each rf sweep to supply a linear time base for an oscilloscope or recorder. In addition, for convenience in recording and other operations, rf sweeps can be triggered electrically externally and single sweeps can be triggered by a front panel push button. The rf output can also be internally AM'd from 400 to 1,200 cps and externally AM'd or FM'd over a wide range of frequencies.

### Rapid Visual Presentation

The variety of sweep rates and band widths available from the new oscillators insures convenience and accuracy for reflection and transmission coefficient measurements and many other production line and laboratory tests. For maximum speed, an oscilloscope such as -hp- 130A/B may be used as indicated in the diagram on opposite page. For maximum information and a permanent record, an X-Y or strip chart recorder may be used.

Complete details of a rapid visual method using an oscilloscope or a maximum-data, permanent record method using a recorder may be obtained from your -hp- field engineer. Detailed discussions of these methods are also contained in the -hp- Journal, Vol. 8, No. 6, and Vol. 9, No. 1-2, available on request.

### TYPICAL SPECIFICATIONS

Below are specifications for -hp- 686A Sweep Oscillator, 8.2 to 12.4 KMC. Specifications for -hp- 684A (G band), 685A (J band), and 687A (P band) are similar except for frequency range.

**Types of Outputs:** Swept Frequency, CW, FM, AM.

#### Single Frequency Operation

**Frequency:** Continuously adjustable 8.2 to 12.4 KMC.

**Power Output:** At least 10 milliwatts into matched waveguide load. Continuously adjustable to zero.

#### Swept Frequency Operation

**Sweep:** Recurrent; externally triggered; also manually triggered single sweep. Rf sweep linear with time.

**Power Output:** At least 10 MW into matched waveguide load. Output variations less than 3 db over any 250 MC range; less than 6 db over entire 8.2-12.4 KMC range.

**Sweep Range:** Adjustable in 7 steps 4.4 MC to 4.4 KMC.

**Sweep Rate-of-Change:** Decade steps from 32 MC/sec. to 320 KMC/sec.

**Sweep Time:** Determined by sweep range and rate; from 0.014 to 140 seconds over full-band.

**Sweep Output:** +20 to +30-volt-peak sawtooth provided at a front-panel connector concurrent with each rf sweep.

#### Modulation

**Internal Amplitude:** Square wave modulation continuously adjustable from 400 to 1200 cps; peak rf output power equals cw level.

**External Amplitude:** Direct coupled to 300 KC; 20 volt swing reduces rf output level from rated cw output to zero.

**External Pulse:** +10 volts or more, 5 millisecond maximum duration.

**External Frequency:** FM and external sweep voltages.

#### General

**Input Connectors, Impedances:** BNC; above 10,000 ohms.

**Output Connector:** Waveguide cover flange; SWR less than 2:1.

**Power Requirements:** 115/230 volts 50/60 cps ac; approximately 475 watts.

**Price:** -hp- 684A (3.95-5.85 KMC) \$2,265.00

-hp- 685A (5.30-8.20 KMC) \$2,265.00

-hp- 686A (8.20-12.40 KMC) \$2,615.00

-hp- 687A (12.40-18.00 KMC) \$3,115.00

(Prices above are f.o.b. factory for cabinet models. Rack mount instruments \$15.00 less.)

Data subject to change without notice.

### HEWLETT-PACKARD COMPANY

4478A Page Mill Rd. • Palo Alto, California, U.S.A.

Field Representatives in All Principal Areas

Cable "HEWPACK" Davenport 5-4451

4478

instruments that speed and simplify your work

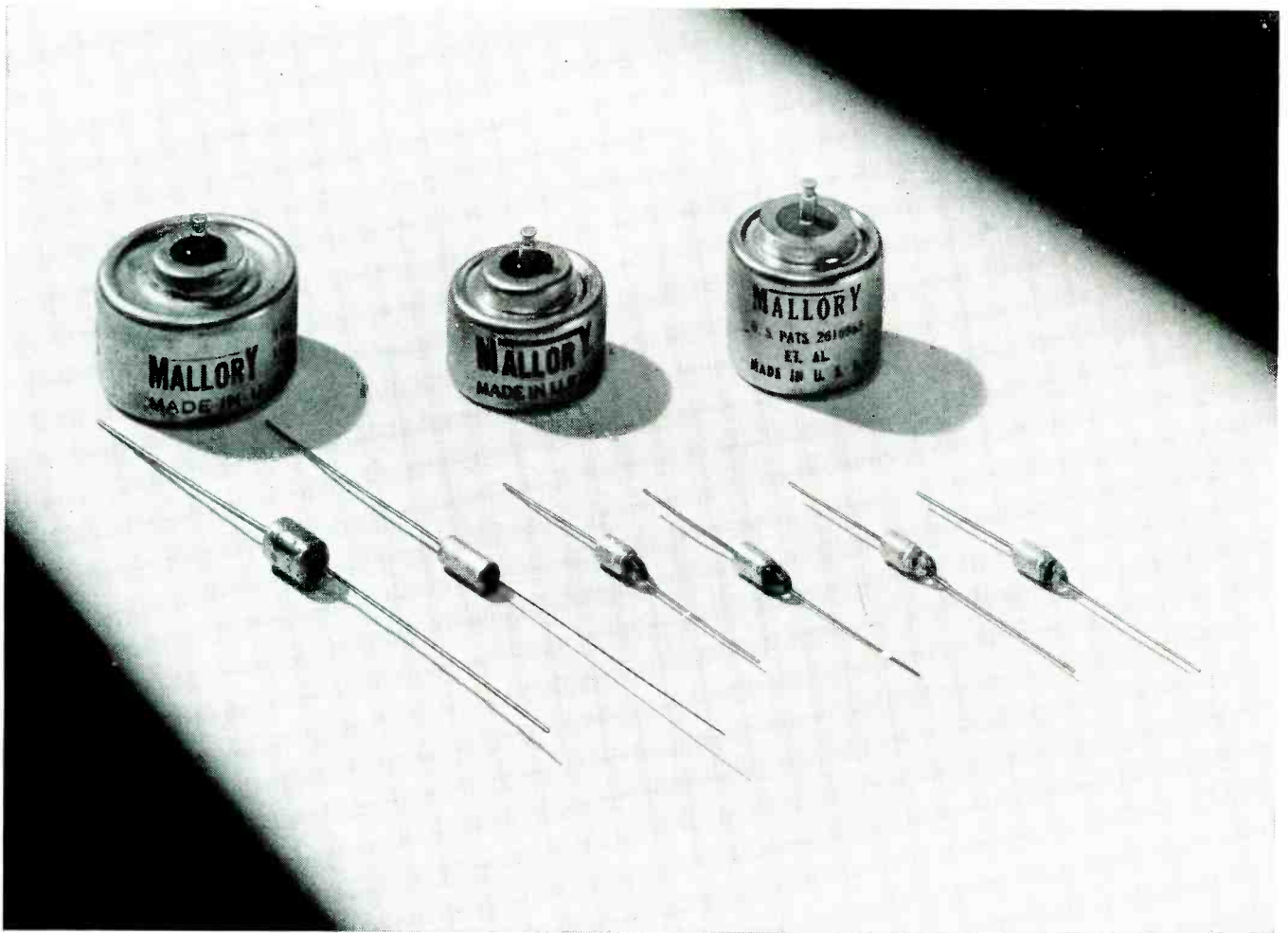

# **NOW!** Mallory Tantalum Capacitors *...delivered from stock!*

Tantalum capacitors for high temperature applications, such as missile guidance systems, radar and other uses involving extreme environmental conditions, can now be obtained from Mallory on a considerably shortened delivery schedule. This new improvement in availability removes a basic industry problem which has frequently deterred engineers from capitalizing on the superior performance of tantalum capacitors.

Recent advances in Mallory processing techniques make it possible for us to deliver popular ratings of tantalum capacitors *directly from stock* . . . and to assure shipment of *all* types in a maximum of six weeks without special allocation.

Stepped-up delivery applies to all Mallory tantalum capacitors . . . the XTL, XTH for 200°C operation, new miniature XTM types designed for 175° C . . . and the TAP, TNT and STNT subminiature types for 85° C in transistor applications and other miniature circuits. Stock deliveries can be made without affecting capacitor performance or life, since these units have virtually unlimited shelf life.

For complete technical data on various Mallory tantalum capacitors, and for engineering consultation on their use, write or call Mallory today.

*Parts distributors in all major cities  
 stock standard Mallory components for your convenience.*

**Serving Industry with These Products:**

**Electromechanical** — Resistors • Switches • Tuning Devices • Vibrators  
**Electrochemical** — Capacitors • Mercury and Zinc-Carbon Batteries  
**Metallurgical** — Contacts • Special Metals • Welding Materials

**Expect more . . . get more from**



## How Transistors Operate Under Atomic Radiation

**SUMMARY** — Results of tests exposing transistor amplifier and single transistor to radiation from nuclear reactor show that degrading effects of irradiation can be controlled to some degree by use of negative feedback when applicable. Radiation effects on coaxial cables showed no noticeable change in r-f transmission characteristics

By **ROBERT L. RIDDLE**

Senior Engineer  
Haller, Raymond and Brown, Inc.  
State College, Pa.

**A**PLICATION of nuclear energy to propulsion of ships, planes and other devices will require electronic equipment to operate under a wide range of nuclear radiation levels. For circuits to function properly, it will be necessary for designers to compensate for irradiation effects on active circuit elements.

Investigations have been made to find the effects of combined gamma and neutron flux on semiconductor devices. The facilities of the Pennsylvania State University pool-type research reactor were used for an experiment involving the effects of reactor radiation on an all-transistor amplifier and crystal video detector. Arrangement of the test is shown in block form in Fig. 1A.

### Test Method

In general, the information desired was the overall performance

of the combined crystal detector and transistor amplifier shown in Fig. 1B. Measurements included tangential sensitivity and transfer ratio of the system (ratio of video output voltage to r-f input voltage). Also determined were r-f attenuation in a coaxial cable extending from the center of the active pile

area to the top of the pool and the  $h$ -parameters and  $I_{co}$  measurements on a single separate transistor in the active pile area. Noise in a properly terminated coaxial cable in the active area was also measured.

The tangential sensitivity was determined under the conditions of a 1,000-mc carrier pulsed by 10-

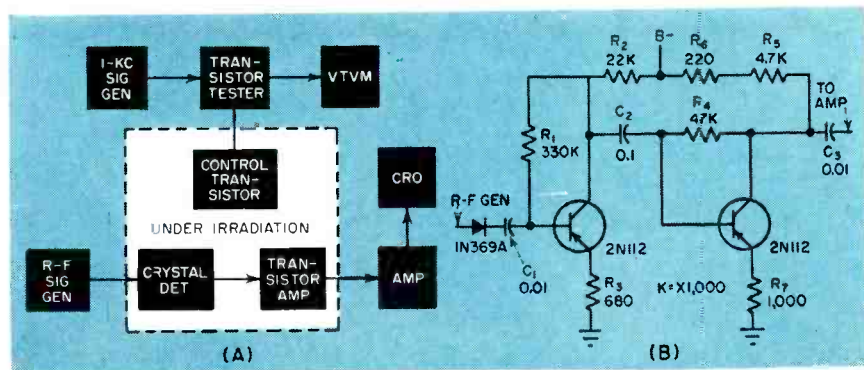

FIG. 1—Equipment setup used in irradiation study (A) with circuit of detector and transistor amplifier (B)

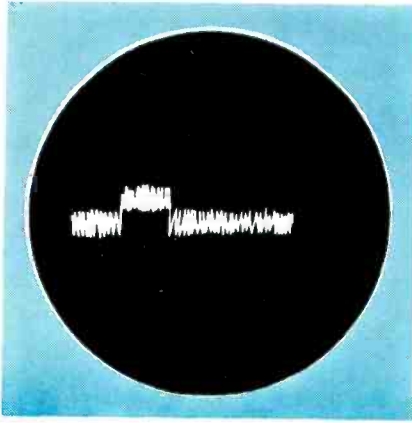
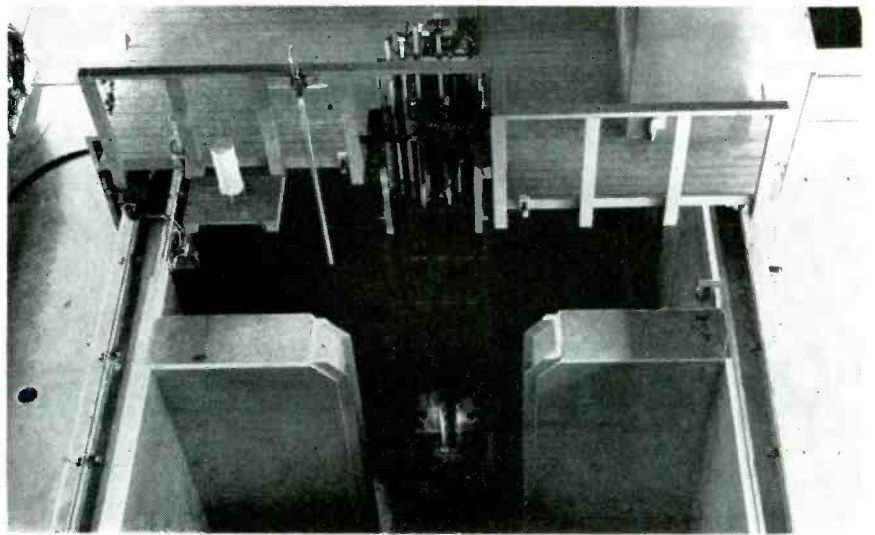

FIG. 2—Oscilloscope pattern used in determination of tangential sensitivity

Pool-type reactor. Amplifier was placed in aluminum tube for insertion in reactor



microsecond rectangular pulses at 5,000 pps. The tangential sensitivity was measured by adjusting reactor power level so that on an oscilloscope pattern the bottom of the noise during the pulse was even with the top of the noise when the pulse was absent. A typical pattern is shown in Fig. 2. The power level input when such a picture is obtained is the tangential sensitivity.

The determination of the transfer ratio was made from the calibrated attenuator on the signal generator and a calibrated oscilloscope.

The control measurements were included so that the primary effects of radiation on the amplifier-detector system could be separated from

possible extraneous effects.

The irradiation schedule is shown in Table I with irradiation times listed for each power level. Neutron flux  $\phi$ , in neutrons per  $\text{cm}^2\text{-sec}$ , is the combined thermal and resonance flux as determined by a cadmium ratio of 9.4 and  $\phi_{\text{thermal}} = 2.07 \times 10^8 \times P$  as found by activation of foils. This gives  $\phi = 2.32 \times 10^9 \times P$ , where  $P$  is the reactor power in watts. Total flux  $\phi$  includes approximately those neutrons between thermal energies and 2 ev.

The duration of each test in seconds and the integrated neutron flux is also given in the table. Gamma dose was determined from

previous calibrations to be equivalent to a dose in roentgens per hour of  $4.93 \times 10^4 P$ . The gamma dose shown in the table is calculated from this equation. The integrated gamma dose was  $3.2 \times 10^6 R$ .

### Test Results

The results of this experiment are shown in Fig. 3. The tangential sensitivity, the most important measurement on a crystal video system, is shown in Fig. 3A and Fig. 3B. Sensitivity decreased as the experiment progressed. There is a recovery in sensitivity as soon as the reactor is turned off as shown by tests 7 and 8. Test 9, which was performed several hours later, still shows about the same sensitivity.

Upon turning the reactor on again, the sensitivity again decreased with increasing flux. The recovery after removing the apparatus from the flux field, represented by test 15, is not as pronounced as that of test 8. Slight improvement is noticed, however, several hours later.

The results of this test show that the sensitivity is affected by flux density as well as integrated flux. The dashed line represents a guess at the probable effects of integrated flux, and the solid line the actual measurements which represent a combination of permanent and temporary effects. The distance between the solid line and dashed line approximates the effects of the temporary degradation as a result of the flux density. This is indicated by the amount of effective

Table I—Exposure Time for Transistors in Reactor

Test No.	Power in watts	$\phi$ in Neutrons per $\text{cm}^2\text{-sec}$	$\gamma$ flux in $\gamma/\text{hr}$	Test duration in sec	Integrated flux density in neutrons per $\text{cm}^2$	Remarks
1	0	0	>100		0	Zero power, residual $\gamma$ only
2	0.3	$0.7 \times 10^6$	300	420	$2.9 \times 10^8$	
3	10	$2.3 \times 10^7$	793	810	$1.95 \times 10^{10}$	
4	$10^2$	$2.3 \times 10^8$	$4.9 \times 10^3$	540	$1.25 \times 10^{11}$	
5	$10^3$	$2.3 \times 10^9$	$4.9 \times 10^4$	420	$9.75 \times 10^{11}$	
6	$10^4$	$2.3 \times 10^{10}$	$4.9 \times 10^5$	420	$9.75 \times 10^{12}$	
7	$5 \times 10^4$	$1.16 \times 10^{11}$	$2.5 \times 10^6$	480	$5.56 \times 10^{13}$	
8	$10^2$	$2.3 \times 10^8$	$\approx 5 \times 10^3$	660	$1.53 \times 10^{11}$	Reactor off
9	Reactor off		$\approx 300$	58,440		Overnight decay
		$2.3 \times 10^8$	$1.9 \times 10^3$	900	$2.09 \times 10^{11}$	Calibrate
	0.13	$3.1 \times 10^5$	$\approx 300$	14,280	$4.3 \times 10^9$	Calibrate & off
10	$10^4$	$2.3 \times 10^{10}$	$4.9 \times 10^5$	1,020	$2.37 \times 10^{13}$	
11	$10^5$	$2.3 \times 10^{11}$	$4.9 \times 10^6$			
12	$10^6$	$2.3 \times 10^{11}$	$4.9 \times 10^6$			
13	$10^6$	$2.3 \times 10^{11}$	$4.9 \times 10^6$			
14	$10^6$	$2.3 \times 10^{11}$	$4.9 \times 10^6$			
15	0	0	0	840	0	Pulled sample out of aluminum tube
16	0	0	0	1,020	0	
17	0	0	0	63,360	0	



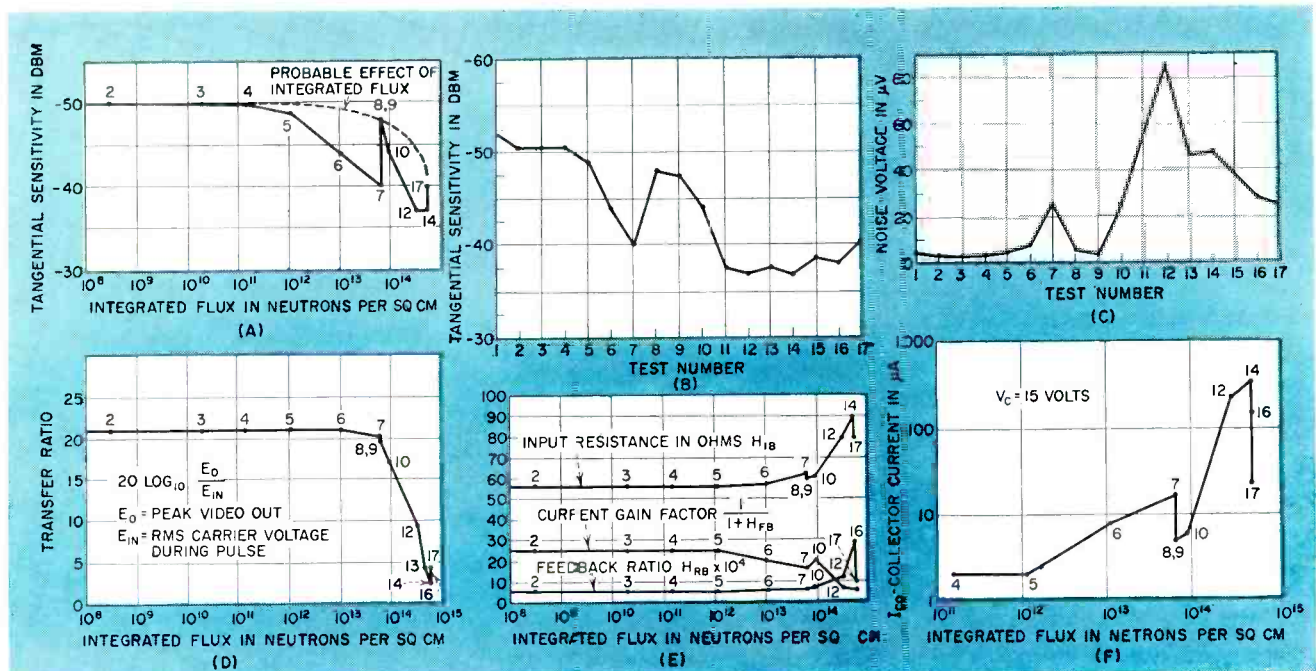

FIG. 3—Results of irradiation study shown graphically are described in text. Numbers on chart indicate test

noise voltage present at the input to the crystal shown in Fig. 3C. This noise voltage is large in those tests where flux density is large. The presence of this noise at these high flux levels results in the decreased tangential sensitivity shown in Fig. 3A and Fig. 3B.

### Transfer Ratio

The transfer ratio, measured as the peak-to-peak pulse output to the rms r-f input, is shown in Fig. 3D. No degradation in this ratio took place until an integrated neutron flux in excess of  $10^{13}$  neutrons per sq cm was reached. From this point on, the transfer ratio dropped rapidly as the integrated flux increased. This same general trend is represented in Fig. 3E which shows the effect on the parameters of the control transistor. This transistor started to degrade at an integrated flux of slightly larger than  $10^{12}$  neutrons per sq cm.

The crystal video circuit maintained its gain for an order of magnitude longer. This is probably a result of the degeneration present in the circuit. The transfer ratio recovered slightly after the device was taken from the flux field. This recovery was gradual and may possibly be due to thermal annealing of the defects produced by irradiation. This same effect is noticed in the control transistor parameters.

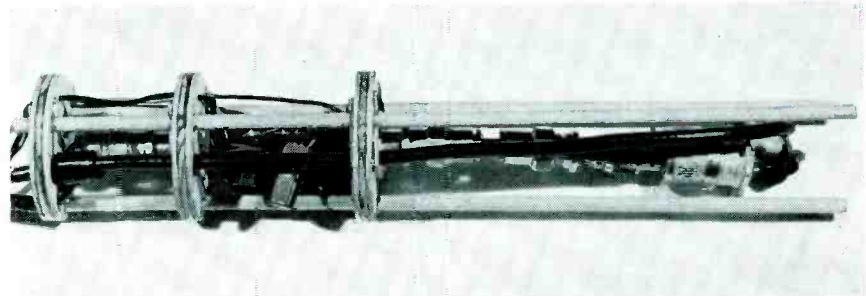

Transistor amplifier used in test is slipped into aluminum pipe to center of reactor

The  $I_{cc}$  of the control transistor was also monitored throughout the test and variation is shown in Fig. 3F. The increase in  $I_{cc}$  may be in part due to internal gamma heating in the transistor.

There was no noticeable change in the r-f transmission through the coaxial cable used as a control. This cable was not monitored for attenuation of video signals.

The noise power produced in a 12-mc bandwidth by the properly terminated cable was -84 dbm residual. The maximum reading on this cable was -82 dbm. This is well below the level of the r-f signal used in the test and also was measured in a much broader bandwidth than that of the crystal detector and transistor amplifier.

Several conclusions may be drawn from this experiment. Fission spectrum irradiation upon semiconductor devices has essentially three

effects. These are transient effects resulting from flux density and gamma heating, semipermanent effects resulting from integrated flux and permanent effects resulting from integrated flux after annealing.

The transient effects caused by flux density are effective mainly in producing noise and increasing  $I_{cc}$ . The gamma heating, the second transient effect, appears to increase  $I_{cc}$  and degrades the transistor in the same manner as any increase in temperature. These effects disappear soon after removal from the flux field.

The semipermanent effects caused by integrated flux result from lattice damage and transmutations. The semipermanent damage results in an overall change in the characteristics of the semiconductor devices which usually degrade their operation.

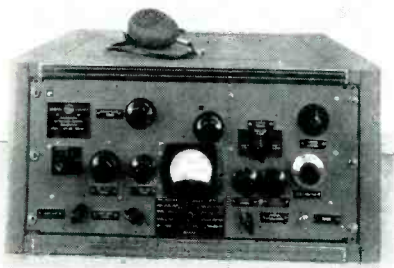

Suppressed-carrier transmitter produces in excess of 100 watts of peak sideband power over the range from 2 to 32 mc

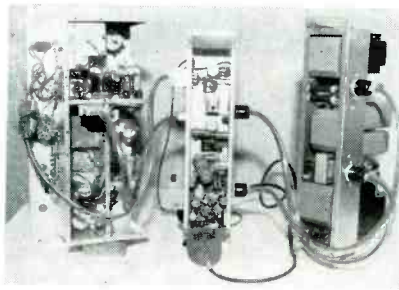

The three sub-units of the suppressed-carrier 100-w transmitter are shown cable-connected for bench testing



Modulation monitor of the one-kilowatt transmitter is visible in the upper right hand corner of the front panel. The three meters to the left of the monitor indicate final stage plate voltage, plate current and load voltage. The r-f unit, modulator and high voltage power supply are panel-mounted below the modulator panel.

# Transmitter Circuits For

**SUMMARY** — Up-to-date transmitting techniques, used to produce suppressed-carrier double-sideband signal, improve efficiency of a-m general-purpose communications transmitters. Transmitters, capable of one-kw and 100-w peak sideband power over 2 to 32-mc frequency range use class C push-push power amplifiers with push-pull screen-grid modulation

By **J. P. COSTAS** and **R. W. FRENCH**

*Defense Electronics Division  
General Electric Company  
Utica, N. Y.*

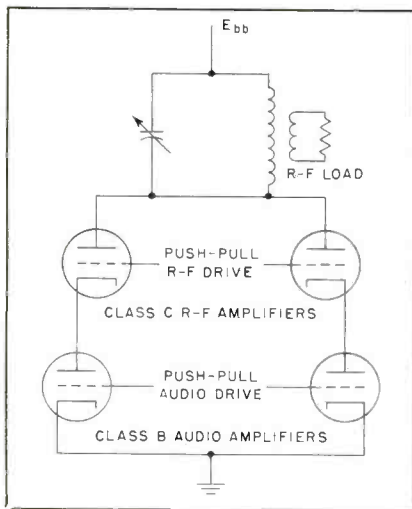

FIG. 1—Series-modulation circuit for suppressed-carrier a-m signal generation

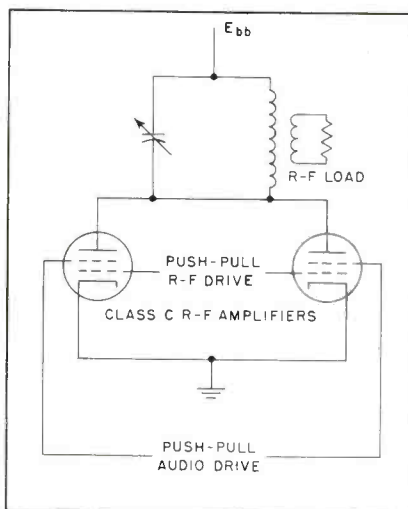

FIG. 2—Screen-grid modulation circuit for suppressed carrier a-m signal generation

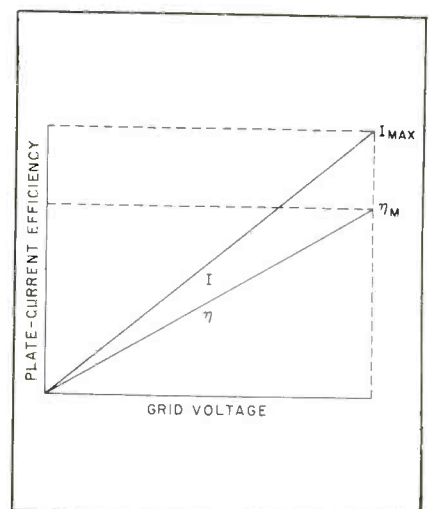

FIG. 3—Current and efficiency curves for grid-modulated class C r-f amplifier

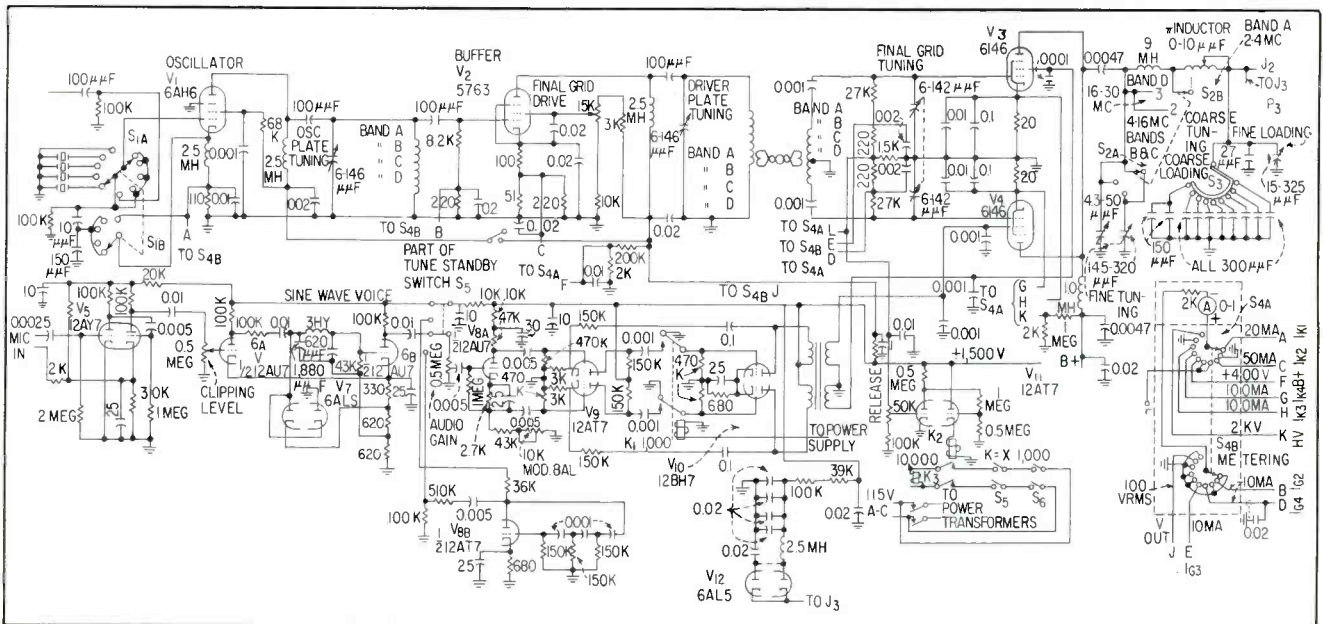

FIG. 5—Circuitry of 100-w transmitter covers the frequency range in four bands of an octave each by using plug-in coils. Nominal output impedance is 50 ohms but impedances up to 500 ohms can be matched over most of the frequency range

# Suppressed-Carrier A-M

INVESTIGATIONS to find a more advanced modulating technique to replace a standard a-m system reveal that if a-m is optimized by giving it the same advantages proposed for single sideband, the optimized a-m system is the practical choice for general-purpose communications.

This article presents transmitting techniques used to produce a

suppressed-carrier double-sideband a-m signal.

## Eliminating Carrier

Suppressed-carrier a-m signals and balanced-modulator circuits for generating such signals are described in most standard texts on vacuum tube circuits.<sup>1</sup> Although the carrier component in a standard a-m signal contributes nothing to the transmission of intelligence contained in the sidebands and represents a sizable percentage of the total signal power, the carrier component is mandatory for proper operation of all commonly employed second detectors.

Elimination of the carrier allows appreciable reduction in size, complexity and cost of a transmitter for a given sideband output. Recent advancements in receiver development make the presence of the carrier in the transmitted signal unnecessary.<sup>2</sup>

## Series Modulation

Several configurations may be used to produce a suppressed-carrier double-sideband signal. One such circuit is shown in Fig. 1.

Although this particular arrangement has practical disadvantages, analysis of its operation is instructive.

Assuming a sinusoidal audio drive and idealized class-B operation of the audio power amplifiers, plate current then flows alternately through the class-C tubes in the form of half sine waves. The output r-f envelope is a full-wave rectified sine wave with the r-f polarity changing by 180 deg each time the envelope passes zero.

## Resistive Load

Since the change in d-c plate voltage across a class-C r-f amplifier is nearly a linear function of the d-c plate current, the two r-f tubes appear as resistive loads to the class-B audio amplifiers. Thus, the d-c power drawn from the supply is converted first to audio power by the class-B audio tubes. The class-C r-f tubes receive and convert this audio power to sideband r-f power fed to the load.

Overall efficiency in the conversion of d-c power to r-f sideband power is excellent since class-B audio and class-C r-f amplifiers are

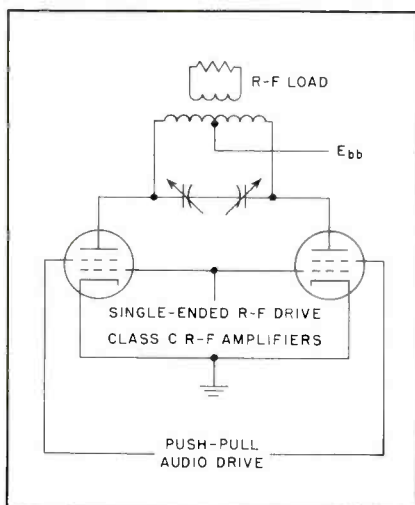

FIG. 4—Alternate screen-grid modulation circuit

most efficient in this respect.

The overall efficiency,  $\eta_o$ , of the circuit in Fig. 1 is expressed as

$$\eta_o = P_{r-f \text{ avo}} / P_{d-c} = \pi \eta_m / 4 \quad (1)$$

### Screen-Grid Modulation

In the balanced modulator shown in Fig. 2, a pair of class-C amplifiers, driven in push-pull from the r-f exciter, are screen modulated with a push-pull audio signal. A d-c bias, applied to the screens, cuts off both r-f tubes in the absence of audio drive. Both the efficiency and d-c plate current increases in a nearly linear manner with modulating voltage as shown in Fig. 3. At the peak of the modulating cycle, the class-C efficiency will be at least equal to the normal value  $\eta_m$  of the series-modulated circuit shown in Fig. 1. With a sinusoidal modulating signal, the current drawn from the power supply will be a rectified sine wave with a peak value of  $I_{max}$ .

The overall efficiency,  $\eta_o$ , of the circuit of Fig. 2 in converting d-c power to r-f sideband power is the same as that for Fig. 1.

### Peak Sideband Power

If the combined plate dissipation  $P_d$  of the two grid-modulated tubes is given, then the peak r-f power output  $P_{r-f \text{ peak}}$  will be

$$P_{r-f \text{ peak}} = 2 P_d / [(4/\pi \eta_m) - 1] \quad (2)$$

Equation 2 provides a quick estimate of peak sideband power output available from a given pair of tubes used in the circuit of Fig. 2 under conditions of sine-wave modulation.

In a practical screen-grid circuit, some d-c plate current flows in the

absence of modulation. In addition, the minimum instantaneous plate voltage on modulation peaks must be limited to the peak modulator voltage on the screen grid or clipping of the modulation envelope peaks will occur. These two conditions will lower the plate efficiency.

An overall efficiency of 50 percent, based on r-f power delivered to the load, is readily obtainable in practice using sine-wave modulation. As shown in Fig. 3, the efficiency of the final stage is proportional to the amplitude of modulation voltage on the screen grid. Thus, efficiency is increased by using a modulator waveshape having a low form factor.

By using speech clipping in the modulator, a square wave is approached and the resultant increase in efficiency and average power output makes possible an even further reduction in equipment size for a given sideband power output.

### Transmitter Design

The principal differences between the suppressed-carrier transmitter and a standard a-m transmitter occur in the final-stage circuitry, the method of modulation and the modulation power required. Figure 2 is a class-C push-push power amplifier with push-pull screen-grid modulation. Control grids of the tubes are driven by the r-f excitation.

An alternative circuit, Fig. 4, has the control grids in parallel and the plates in push-pull. Circuit choice is usually dictated by the plate circuit network desired.

An incidental advantage of the balanced-modulator circuit is its

self-neutralizing feature.

The modulation power required is only a few percent of the r-f output power. This low modulation power, plus elimination of the carrier, permits considerable saving in size and weight compared to a standard a-m transmitter using high-level modulation. Screen grids of the final tubes are returned to ground or to a negative bias. The low standby plate power input, in the absence of modulation, permits high output power on voice peaks without exceeding the average plate dissipation rating of the final tubes.

### Distortion Compromise

Because the screen-grid voltage against plate-current characteristic becomes less linear as the screen-grid voltage is made more negative, a compromise between standby plate power input and audio distortion is necessary in establishing the value of bias to be used. Push-pull modulation reduces even-order distortion due to the nonlinear screen-grid characteristic. Distortion may also be reduced by employing r-f or audio plate-current feedback.

Modulator design for speech is straightforward. The two principal differences between this modulator and that in a plate-modulated standard a-m transmitter are: the lower output power of the former and the addition of an audio oscillator for modulation during final-stage tuning and loading adjustments.

The final-stage plate-voltage supply should have fairly good regulation as the plate current variation when voice modulation is used is similar to a class-B modulator stage.

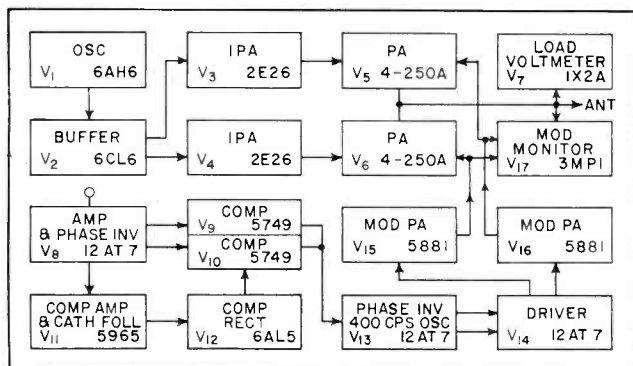

FIG. 6—Block diagram of the 1-kw transmitter uses a voice-compressor circuit in the modulator

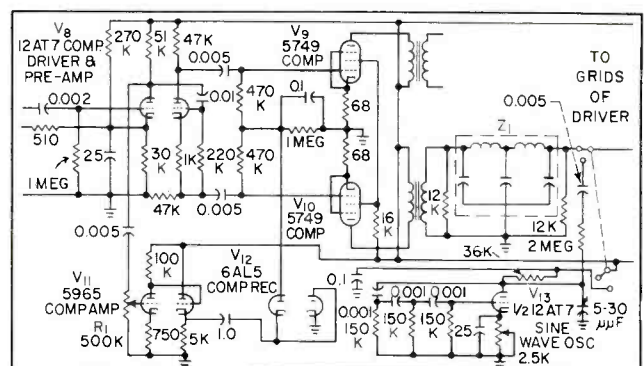

FIG. 7—Voice compressor circuit, of the 1-kw transmitter, has a linear compression range of 13 to 20 db which is set by  $R_1$

The developmental transmitter produces over 100 watts of peak sideband power over the frequency range from 2 to 32 mc. The schematic is shown in Fig. 5.

The exciter is of conventional design. The frequency range is covered in four bands of an octave each by using plug-in coils.

A clipper-filter raises the average power output on voice operation. Stage  $V_{8u}$ , an R-C phase-shift oscillator, provides a 400-cps sine wave for modulation during final-stage tuning and loading. A single 12BH7 dual triode  $V_{10}$ , used as a class AB<sub>1</sub> modulator, provides power for modulating the pair of 6146 final tubes  $V_3$  and  $V_4$ . Relay  $K_1$  prevents modulation when the final stage plate voltage is off, thus protecting the final tube screen grids against damage in case of accidental modulation.

### Protection

Time-delay and final-stage protection is provided by  $V_{11}$  and associated components. Relay  $K_2$  is not energized until the equipment has been on for at least 30 seconds and unless the final-stage grid current is above a minimum predetermined value.

Because the contacts of  $K_2$  are in the coil circuit of plate transformer relay  $K_3$ , the mercury-vapor rectifiers are protected against premature application of plate voltage and the final tubes are protected against loss of drive. A peak detector circuit, provides an indication of output voltage, convenient when tuning and loading the final stage.

The pi-network, used to match the final tubes to the load, gives good harmonic reduction and permits matching a wide range of load impedances. Nominal output impedance of the transmitter is 50 ohms but impedances up to 500 ohms can be matched over most of the frequency range.

Complete metering of the transmitter is provided by the milliammeter and selector switch  $S_1$ .

### 1-kw Transmitter

The 1-kw transmitter is capable of 1-kw peak sideband power output over the range from 2 to 32 mega-

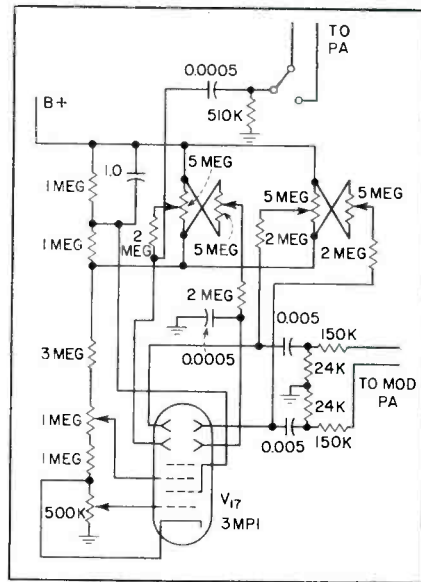

FIG. 8—Modulation monitor of the 1-kw transmitter uses a 3MP1 crt

cycles and is scaled-up version of the smaller one just described with some added refinements.

A block diagram of the 1-kw transmitter is shown in Fig. 6. A voice compressor circuit shown in Fig. 7 is used in the modulator. It has a linear compression range of 18 to 20 db, depending on the initial compression level, set by potentiometer  $R_1$  in the grid circuit of the first triode of  $V_{11}$ . Attack time of the compressor is approximately 5 millisecc and the release time is 0.2 sec. Above the linear compression range the compressor output falls off, preventing over-modulation and clipping of the r-f envelope. Low-pass filter  $Z_1$  following the compressor has a cutoff of 3500 cps, with a minimum attenuation of 40 db above cutoff.

### Modulation Monitor

A 3MP1 crt,  $V_{17}$ , is used as a modulation monitor. The circuit is shown in Fig. 8. The bow-tie pattern obtained during modulation provides a check on modulation linearity and is useful during tuning and loading of the final stage. A 2-to-1 and 4-to-1 attenuation of the r-f signal applied to the vertical deflection plates ensures usable pattern size for a wide range of load impedance.

The exciter portion of the transmitter is bandswitched. The only bandswitching required in the final

plate circuit is the application of additional shorting contacts on the unused portion of the variable inductor, on the two highest frequency bands to prevent self-resonances of the unused portion of the inductor from occurring at the operating frequency.

### Final Stage

A combination of series and parallel feed is used in the final stage plate circuit. No commercially available r-f choke was found to have sufficiently high impedance over the continuous frequency range employed to allow its use as a parallel-feed directly to the tube plates. Satisfactory operation was obtained by shunt feeding at the load end of the variable inductor, where impedance level and thus r-f voltage are much lower than at the plate end.

Line power consumption with sine-wave modulation and an output of 1-kw peak sideband power is 1,850 watts. The developmental unit weighs 310 pounds, but no special effort was made to produce a unit of minimum size and weight.

### Power Gain

The transmitter simplicity which results from dsb operation, particularly the self-neutralizing feature, is especially convenient when tubes having high power gain are employed in the final.

Power gain for voice transmission, obtained by simple clipping and filtering techniques, can easily result in 10 db or more increase in average sideband power for a given peak sideband power. The high-level dsb circuit is especially useful since the tubes are operated at class-C efficiency levels. This becomes important when talking power must be kept high while space, weight, and unit input power must be kept low.

Much of the work reported here was sponsored by the Rome Air Development Center of the Air Research and Development Command under Contract AF 30(602)584.

### REFERENCES

- (1) F. E. Terman, "Radio Engineering", 3rd Edition, p. 489, McGraw-Hill Book Co., Inc., New York, 1947.
- (2) J. P. Costas, "Synchronous Communications," *Proc IRE*, p. 1.713, 44, Dec. 1956.

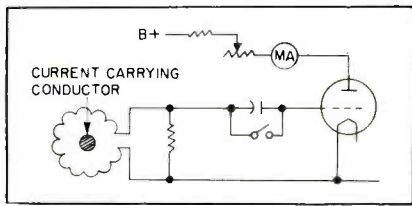
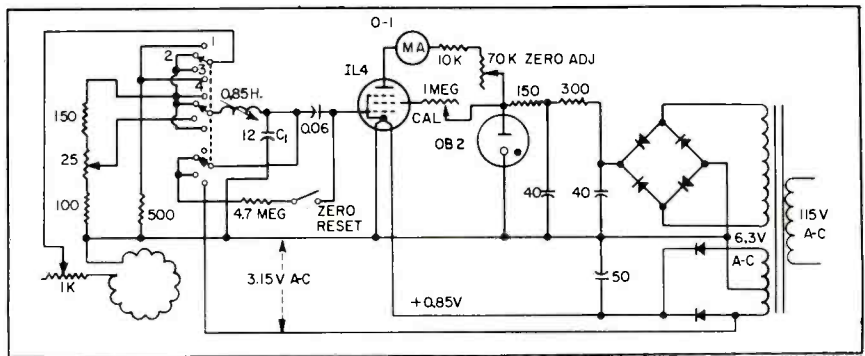

FIG. 1—Basic welding current meter

FIG. 2—Complete welding current meter has four-position selector switch; position 1, no signal input; 2, 0 to 15,000 amperes; 3, 0 to 30,000 amperes; 4, calibration



**SUMMARY** — Voltage developed by toroidal pickup coil around welding electrode is converted to steady-state meter reading by a-c vtm circuit. Accuracy is within 3 percent of full-scale meter deflection for weld times of 3 to 30 cycles. Meter holds reading several minutes before needle returns to zero

By **PATON M. ZIMMERMAN**

*Senior Process Engineer  
Fisher Body Div., General Motors Corp.  
Detroit, Michigan*

## Toroid Measures



Fourteen-pound meter is completely self-contained. Weld-time correction curve in cover increases accuracy to 1 percent. Meter readings in ma are calibrated linearly in kiloamperes of secondary welding current

**S**EVERAL METHODS of measuring current in the secondary or welding circuit of an a-c resistance welding machine are in common use. These methods pose problems, such as the need for frequent and careful calibration, the necessity for several current transformers to cover the range of welding currents encountered, the loading of the secondary circuit with magnetic materials thereby changing its inductance, or the requirement of disconnecting and reconnecting the wiring of the welding equipment.

### Basic Toroid Coil

An improvement over the standard methods of instrumentation is provided by an air-core transformer or toroidal coil placed around one of the welding electrodes and connected to a suitable circuit, as shown in Fig. 1, to permit a direct reading in terms of actual welding current.<sup>1</sup>

The voltage developed by the toroid is a function of the rate of change of magnetic flux produced by the alternating current flowing

through the electrode and the resistive load across the toroid. Only the magnetic flux produced by a conductor inside the toroid will have any effect on this voltage. Flux produced by conductors outside the toroid, even immediately adjacent to it, will not produce any toroid voltage.

The toroid is a differentiating unit; therefore, the current flowing through the load across the toroid is 90 deg out of phase with the current in the conductor around which the toroid is placed. This presents no problem unless the welding current has a waveform other than a sine wave, such as when the current is phase shifted for heat control. With nonsinusoidal waveforms, the differentiated toroid output current will not resemble the welding current in waveform.

### Practical Circuit

A peak reading a-c vtm is employed in the circuit of Fig. 2 to measure the toroid output voltage, since welding currents normally



Engineer calibrates resistance-welding current meter. Direct-reading feature permits operation by nontechnical personnel

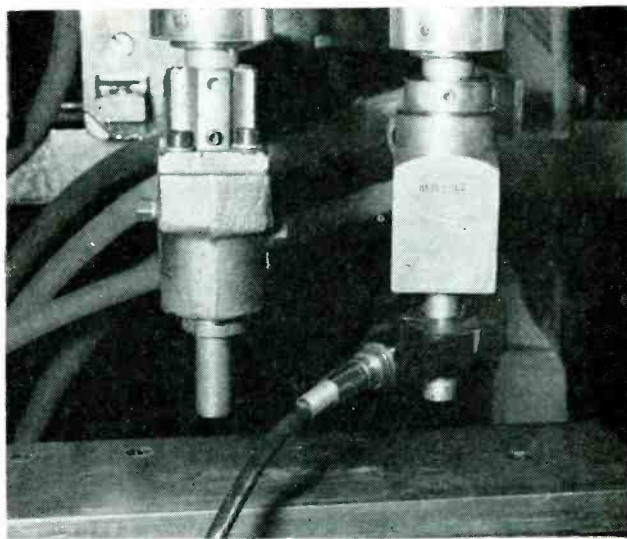

Closeup shows pickup toroid encircling welding electrode. Toroid can be used with 1/2, 3/8 and 3/4 in. diameter electrodes

# Spot Weld Current

last for only a few cycles.

The toroid voltage is applied to the grid of the 1L4 pentode. A capacitor in the 1L4 grid circuit is charged by grid rectification to the peak value of the voltage developed by the toroid; this capacitor voltage determines the negative grid bias of the tube. The plate current passing through the tube is proportional to the grid bias and is indicated by the milliammeter.

## Meter Reading

A maximum plate current of 1 ma will flow when the toroid output voltage is zero; any voltage produced by the toroid will increase the grid bias and decrease the plate current causing the meter to read backward in effect.

Meter readings in ma are calibrated linearly in terms of kiloamperes of secondary welding current; this results in a multiplication factor of one million to one.

The variable resistance in series with the meter permits adjustment of the maximum plate current to exactly 1 ma. The pushbutton

switch can be used to short the grid capacitor after each reading.

The selector switch is provided with four positions. Suitable range resistors are incorporated for the two measuring positions and adjustment is provided to make the high range exactly twice the low range. In the no-signal input position, the toroid may be left in position around the welding electrode with no meter indication.

The d-c filament supply has an adjustable output of 0.85 to 0.9 v. This voltage is critical since the filament acts as the electron source. A lower than normal filament voltage permits measuring lower welding currents, since the cathode-to-ground potential is the limiting factor on the minimum toroid voltage that will effect a change in grid bias.

## Calibrator

A built-in calibration circuit applies 3.15 v from one-half of the filament winding across the range resistors to charge the grid capacitor to 3.15 v. A band on the meter

face indicates when this value of grid bias produces the correct plate current.

The 1L4 screen-grid voltage can be varied to control its gain.

The pickup coil consists of a uniformly wound toroidal coil having 12,000 turns with a resistance of approximately 270 ohms and an inductance of approximately 60 mh. The coil is encased in a resilient potting compound and provided with a screw-type, coaxial microphone connector. The low-pass filter in series with the coil attenuates frequencies over 60 cps to prevent transients, which occur when magnetic welding contactors break, from affecting the meter reading.

Although the welding current meter is actually a peak-reading instrument, calibration is in rms current values since these indicate the heating effect of a current and are commonly used in welding.

## REFERENCE

(1) A. J. Hipperson, A Mains Operated Valve Voltmeter for the Measurement of Secondary Current in Resistance Welding Machines, *Welding Research*, British Welding Research Assoc., p 40, June 1948.

# Dual-Purpose Circuitry

**SUMMARY** — Reflex circuit techniques enable design of 1,750-channel transceiver employing only 35 crystals and 28 tubes. Intended primarily for ground-to-air communications in the 225 to 400 mc range, unit may be installed in either fixed or mobile stations. Transmitter delivers at least 15 watts and receiver has sensitivity of better than 5  $\mu$ v. Spuelch circuit operates on signal-plus-noise to noise ratio

By **PAUL G. WULFSBERG** and **CHARLES H. KIRKPATRICK**

*Asst. Director  
Research and Development*

*Development Engineer*

*Collins Radio Company  
Cedar Rapids, Iowa*

**M**ODERN MILITARY ground-to-air communication requires highly versatile and reliable radio equipment operating in the uhf range. In the set to be described only 35 crystals and 28 tubes are used to obtain 1,750 usable communication channels and to perform all transmitter and receiver functions. Remote-control facilities permit the selection of twenty channels, each of which may be preset to any of the 1,750 frequencies by a built-in memory drum accessible on the front panel.

All channels are instantly available at the manual channel-selector switches.

The receiver sensitivity is less than 5  $\mu$ v for a 10-db signal-plus-noise to noise ratio. The audio output is 1 w into a 600-ohm load and 100 mw into a 120-ohm load. The transmitter output is 15 w or more across the 225 to 400-mc band.

The radio set has facilities for remote control, retransmission and interphone. It is adaptable to vehicular d-c, vehicular a-c/d-c and relay-rack a-c operation. All func-

tions are detailed in the block diagram of Fig. 1.

## **Reflex Technique**

Referring to the receive condition in Fig. 2, the first conversion ratio exceeds 7-to-1 and the second and third conversions are more than 5-to-1 each. The final i-f is 500 kc. This is advantageous for control of frequency drift with temperature and makes possible a bandwidth of 85 kc at the 6-db points and 145 kc at the 60-db points, thus assuring reception of all on-channel signals and adequate rejection of adjacent channels.

The r-f amplifier and first and second i-f amplifiers are reversed in direction by the first and second transmitter mixers. The crystal switching relay associated with the third injection oscillator is employed to index the oscillator switch 180 deg, thereby selecting the appropriate crystal to match the second i-f directly in the transmit mode of operation. This is possible because a combination of high and low side injection is used in the receive condition as tabulated in Fig. 2 for the third crystal frequency.

The synthesis of the transmit signal may now be traced from its origin at the third injection oscillator. From this point it is fed through the third receiver mixer tube into the passive filter which is the receiver second i-f, having a

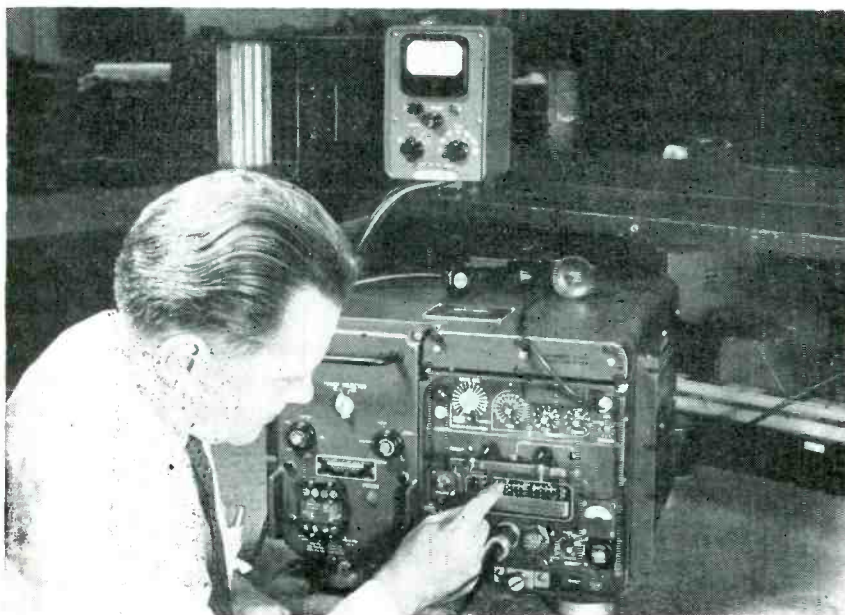

All channels are instantly available by manual switching, while any twenty of them may be preset for remote simplex-only operation



# Cuts Transceiver Size

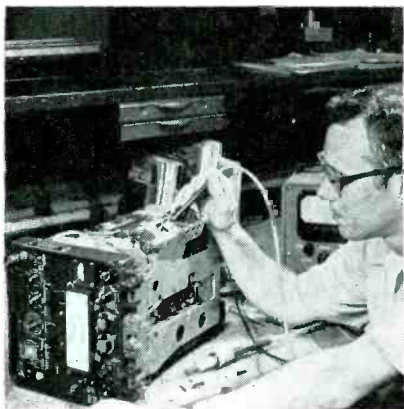

Ruggedness of system doesn't prevent easy access for test and maintenance

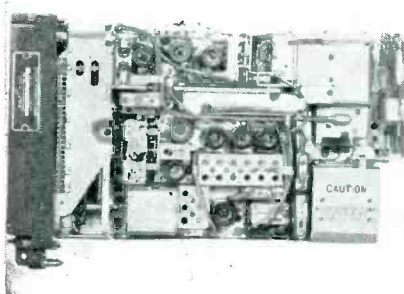

Transceiver interior less power supply shows compact mechanical design required to maintain space requirements

FIG. 1—Simplified block diagram of transceiver, interphone and control circuits. Reflex technique can also be used on indirect systems using crystal-stabilized variable-frequency oscillators

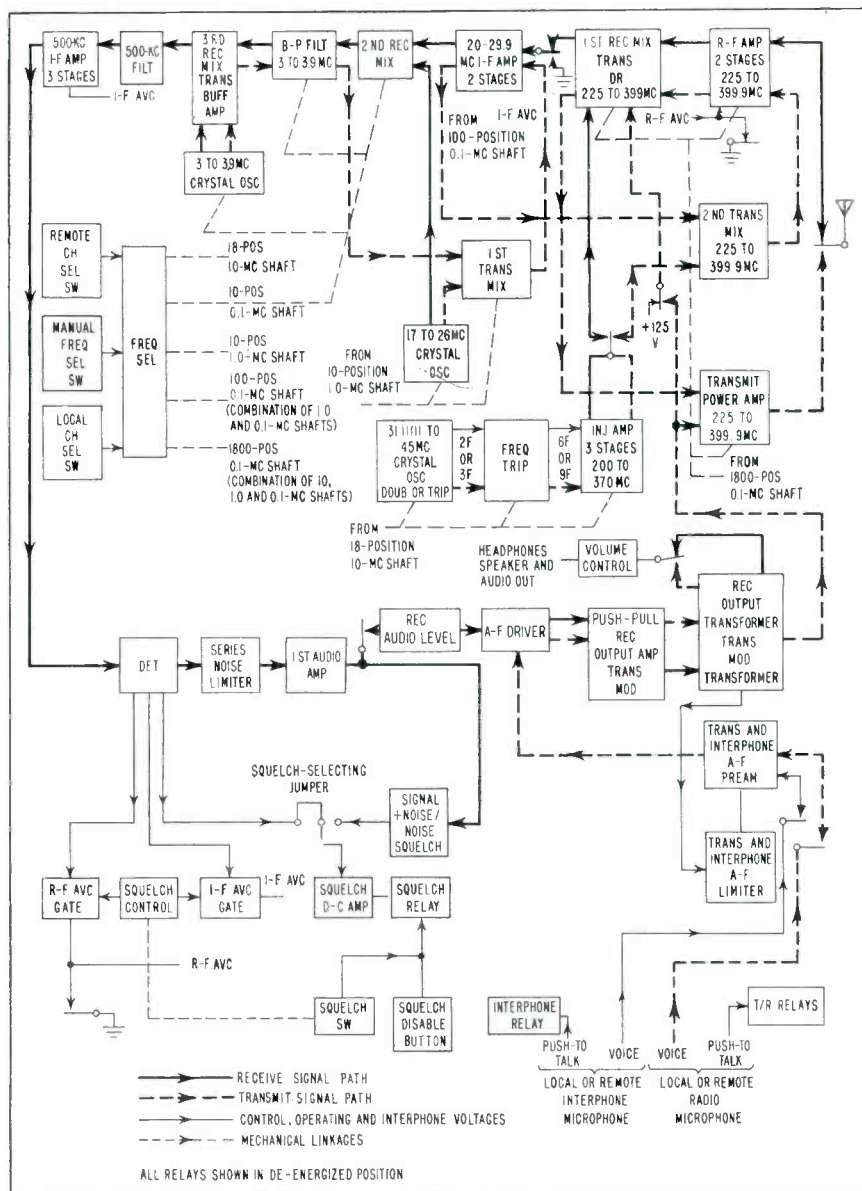

frequency range of 3 to 3.9 mc. From here the signal is fed into the first transmitter mixer where it is added to the 17 to 26-mc second-injection oscillator. Emerging from this mixer as one of the group of 100 frequencies in the range 20 to 29.9 mc, it is then amplified through the first i-f amplifier. From here it is applied to the second transmitter mixer where it is added to the first-injection oscillator system which produces 18 frequencies in the 200 to 370 mc range in 10-mc steps. At this point the

signal emerges at final frequency and passes through the receiver r-f amplifier and thence to the power amplifier and antenna.

## Receiving Mode

Operation of the r-f section of the receiver-transmitter in the receiving mode is straightforward as seen by the path of the 271.7-mc signal through r-f and i-f circuits.

The first and second transmitter mixer and power amplifier are disabled.

As the signal emerges from the

first transmitter mixer, Fig. 3, it is amplified in the first i-f amplifier as a 20 to 29.9-mc signal. From here it is fed to the second transmitter mixer and emerges at output frequency. It is then amplified and at the output of the driver it is well above 1 w in level. A small amount of the output of the first injection oscillator is also fed across the open contact of injection relay  $K_1$  to the driver tube, thus heterodyning the signal back down to the 20 to 29.9-mc region.

Passing through the first i-f am-

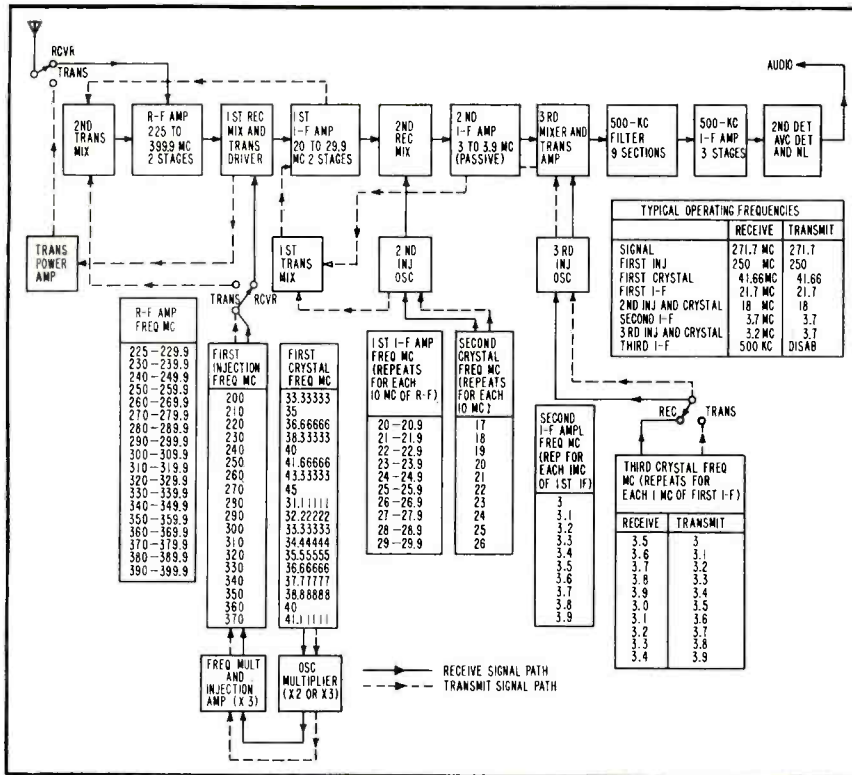

FIG. 2—Basic functional diagram and frequency plan in discrete 100-kc steps

plifier once again, this signal would create a loop oscillation. To eliminate this feedback path a contact is added to the injection-oscillator coaxial relay to ground this path. Since the contact also grounds the first coil of the first i-f amplifier transformer, in Fig. 4, the output of the first transmitter mixer is fed into the second coil of the

transformer to prevent loading of this signal.

The reflex idea is also applied to the audio circuits. The push-pull-parallel modulator and its driver are used as a low-distortion output stage for the receiver, saving two tubes and an output transformer. Since the modulator is operated class  $AB_2$ , the static plate current is

low, providing efficient operation in either the receive or transmit condition. Junction diodes are employed throughout the detector, agc and squelch portions of the audio circuits.

### Spurious Responses

Control of spurious outputs is obtained by several measures: use of conversion ratios of not less than 5-to-1; careful control of mixer levels; proper shielding and filtering of the three oscillator circuits; correct choice of crystal frequencies and high-level mixing in the second transmitter mixer.

The most sensitive point in the set is the first mixer grid where the i-f sensitivity is only 2 or 3  $\mu\text{v}$ . Crystal frequencies are chosen such that harmonics do not fall within the i-f range when the particular crystal involved is used. In this radio set final spurious values of about 80 db are obtained without difficulty.

The set is capable of alignment without the use of a signal generator. An ordinary test voltmeter on the grids of succeeding stages is all that is required for aligning the transmitter up to the driver. At this point the antenna reflectometer is useful for the power amplifier and driver alignment. In production models the final receiver i-f amplifier is factory-aligned and the coils resin-encapsulated. Thus

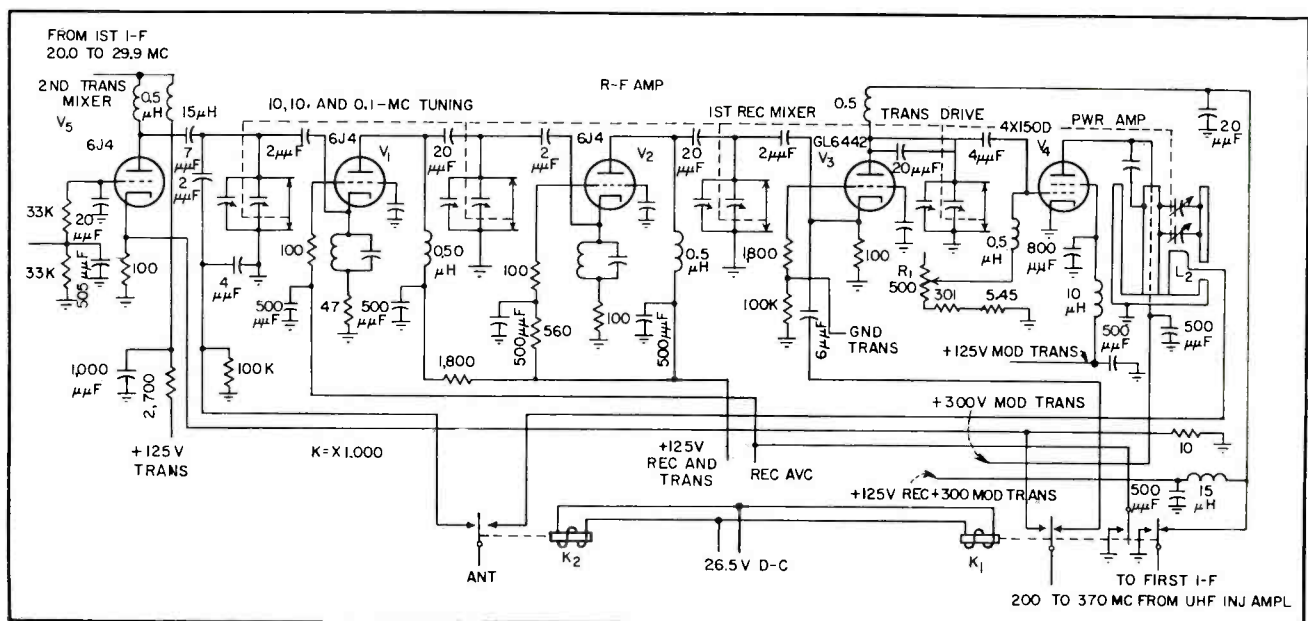

FIG. 3—Radio-frequency sections for transmitter and receiver. Not all circuits are employed in both modes of operation. Final amplifier is cavity-tuned and plate current is adjusted to optimum value by  $R_1$ .

aligning the transmitter does the whole job for the receiver also.

### R-f and Power Amplifier

The circuit of the r-f and power amplifier unit is shown in Fig. 3. Stages  $V_1$  and  $V_2$  provide two cascaded stages of radio frequency amplification in transmit and receive. Stage  $V_3$  operates as a mixer in receive and as a modulated p-a driver in transmit. Stage  $V_4$  is employed as a modulated power amplifier in transmit. Both plate and screen modulation is used. Plate and screen voltages on  $V_4$  are 300 v and 125 v respectively. The screen grid is modulated approximately 55 percent when the plate is modulated 100 percent. Variable grid leak  $R_1$  provides a means of compensating for tube and circuit variations.

The plate current of  $V_4$  is adjusted at 399.9 mc to an optimum value using  $R_1$ . Coupling inductor  $L_2$  adjusts the loading of  $V_4$ . Stage  $V_5$  acts as a high-level plate mixer in the transmit condition. The 20 to 29.9-mc first i-f amplifier signal is injected in the plate circuit of  $V_5$  while the 200 to 270-mc signal is injected in the cathode circuit. Relay  $K_2$  connects the antenna to the cathode circuit of  $V_1$  in receive and to the output circuit of  $V_4$  in transmit.

The plate and screen voltages of  $V_4$  and the plate voltage to  $V_5$  are removed when in the receive mode of operation.

Relay  $K_1$  switches the injection from  $V_3$  in receive to  $V_5$  in transmit. The auxiliary contacts of  $K_1$  disable the avc to  $V_1$  and  $V_2$  as well as the first i-f amplifier feedback path in the transmit mode. The interstage coupling units are uhf tuners of the variable L and C type. By varying both L and C a more constant impedance is maintained by the tuners over the nearly 2-to-1 tuning range of the receiver-transmitter. At the output is a capacitively-tuned coaxial cavity.

The circuit of the first i-f amplifier unit is shown in Fig. 4. The 20 to 29.9-mc first i-f amplifier is tuned to one of the 100 frequencies in its operating range by the 100-position 0.1-mc tuning shaft. This shaft operates to position the slugs in the coupled tuned circuits which

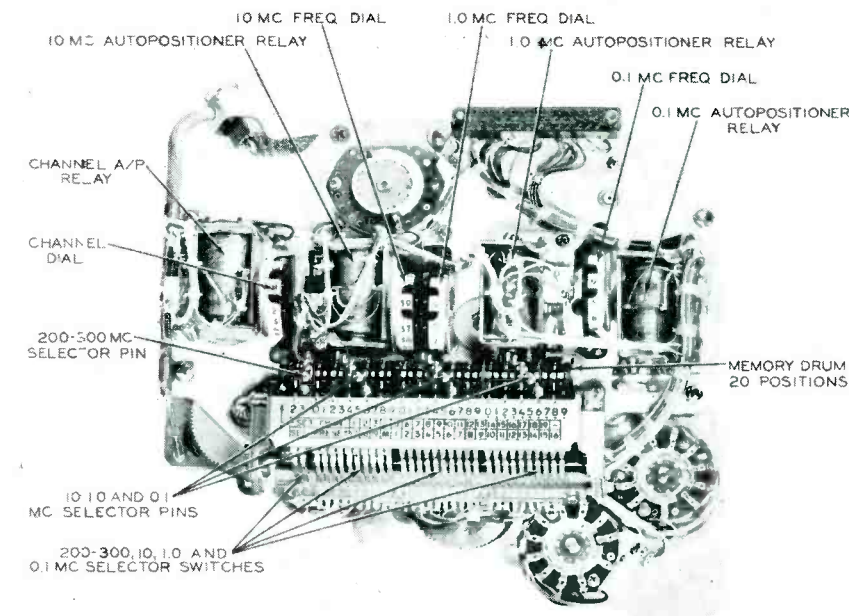

Detail of memory-drum tuning control used in transmitter-receiver unit

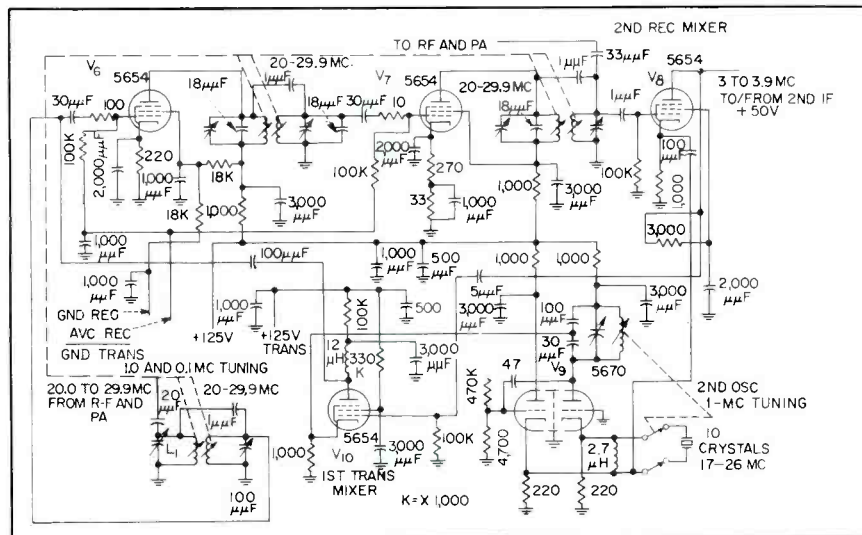

FIG. 4—Receiver first i-f also doubles as intermediate amplifier for transmitter

provide the selectivity required in the first i-f amplifier.

Stages  $V_8$  and  $V_7$  operate as cascaded amplifier stages in both receive and transmit. In receive the second receiver mixer  $V_8$ , operating in conjunction with the second injection oscillator  $V_9$ , converts the 20 to 29.9-mc i-f signal to within the range of 3 to 3.9 mc, the second i-f.

Oscillator  $V_9$  and the ten 17 to 26-mc crystals provide the 1-mc injection frequencies required by  $V_8$  and  $V_{10}$  in receive and transmit respectively. First transmit mixer  $V_{10}$  converts the 3 to 3.9-mc second i-f and the 17 to 26-mc crystal fre-

quency to the range of 20 to 29.9 mc for the first i-f amplifier. Stage  $V_8$  is disabled in transmit and  $V_{10}$  is disabled in receive by removing plate voltage.

The circuit of the 3 to 3.9-mc second i-f amplifier and the 500-kc filter is presented in Fig. 5. The slug-tuned 0.1-mc tuning units provide the selectivity required in the second i-f amplifier.

The 10-position 0.1-mc tuning shaft determines the slug settings and is ganged to the 3 to 3.9-mc crystal-selector switch. One-half of  $V_{11}$  operates as an oscillator in receive and transmit. The other

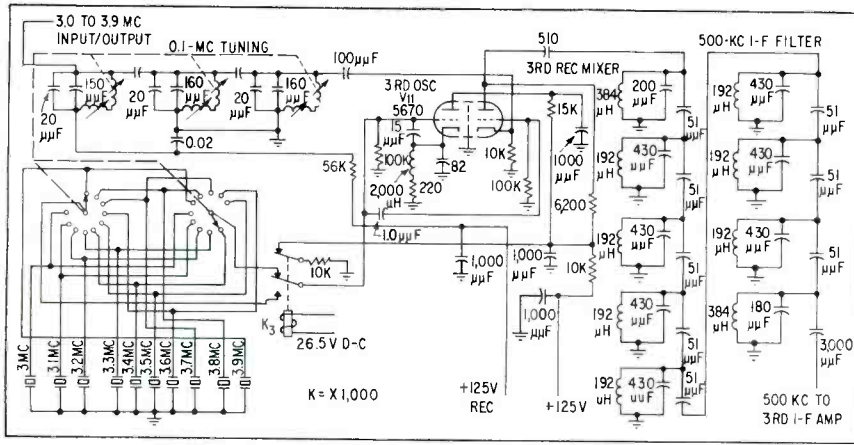

FIG. 5—Second i-f includes oscillator and filter for both transmit and receive

half operates as a mixer in receive and as a cathode follower amplifier in transmit.

In both the receive and transmit the output of the oscillator section of  $V_{11}$  is coupled to the grid of the mixer-amplifier section. In receive the output of the tuning circuit is coupled to the cathode of  $V_{11}$ . The output frequency of the oscillator mixing with the 3 to 3.9-mc second i-f results in an output of 500 kc which appears at the plate of  $V_{11}$ .

The output signal is fed to the 500-kc i-f filter. In transmit relay  $K_3$  operates to shift the crystal frequency 500 kc so it matches the third i-f. The output of the oscillator is thus fed through the mixer-amplifier section of  $V_{11}$  now operating as a cathode follower. The output of the second i-f unit is then fed to the first i-f unit. No amplification of the 3 to 3.9-mc signal is necessary in the receive condition.

The adjacent-channel selectivity of the receiver is determined by a 9-section lumped-constant filter. By lumping the principle selectivity-determining unit ahead of the final 500-kc i-f amplifier, where most of the gain of the receiver is concentrated, cross-modulation resulting from strong adjacent channel signals is minimized.

The third i-f amplifier contains three stages of video-coupled amplification comprising the second detector, r-f and i-f avc gates, a series noise limiter and the first receiver a-f amplifier. The circuitry is conventional.

An a-m receiver normally employs a squelch which depends on

the incoming signal level to generate enough rectified signal at the detector to operate a gate circuit.

This system, however, is susceptible to any changes in overall r-f gain between the antenna and aural detector. Factors such as tube aging and line voltage changes thus affect the squelch operating threshold. Also, since the gain of a multichannel set inherently varies somewhat across the band, squelch sensitivity is dependent on frequency.

### Squelch Circuit

To eliminate these problems a squelch system is used which depends only on the relative ratio of signal and noise. If this system is set to operate at a signal-to-noise ratio of, say, a minimum readable signal level of 3 db, the squelch then opens whenever this value is reached, regardless of varying circuit conditions.

The circuit of the signal-to-noise ratio squelch is presented in Fig. 6. The output of the first receiver audio amplifier is applied to the audio input terminal of the  $(s+n)/n$  ratio sensing circuit.  $R_2$  and

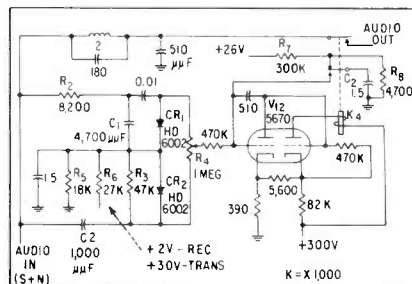

FIG. 6—Squelch system uses signal plus noise-to-noise sensing circuit

$C_1$  form a low-pass R-C filter which passes voice frequencies only. The signal-plus-noise output of this filter is applied to  $CR_1$ , which rectifies the low-frequency signals causing the end of  $R_8$  connected to the anode of  $CR_1$  to be negative.

Capacitor  $C_2$  and resistor  $R_8$  form a highpass filter which passes only frequencies above the voice band. The output of this filter is applied to  $CR_2$  which rectifies the noise, causing the end of  $R_4$  connected to the cathode of  $CR_2$  to be positive. Since the currents flowing in  $R_4$  due to the actions of the signal-plus-noise rectifier and the noise rectifier buck each other, the d-c output fed to the grid may have a positive, negative or zero value depending on the setting of  $R_4$  and the signal-plus-noise to noise ratio.

If it is assumed that the bandwidth of the two filters are equal, and that the two rectifiers develop equal and opposite currents in  $R_4$ , then the center of  $R_4$  would be at zero potential when no signal (noise only) is being received. When no signal or an unmodulated signal is applied, the d-c output of  $CR_1$  and  $CR_2$ , because of the noise, has a 1:1 ratio.

The output of  $CR_1$  is increased because of the presence of the voice-modulated signal and a negative potential is thus applied to the grid of  $V_{12}$ , cutting off this section of the d-c amplifier. This allows the second section of  $V_{12}$  to draw plate current which energizes squelch relay  $K_4$ . Adjusting  $R_4$  provides a means of selecting the desired  $(s+n)/n$  ratio and also of compensating for circuit variations.

Resistors  $R_6$  and  $R_8$  form a bleeder which applies a slight positive bias to the grid of  $V_{12}$ . This bias is required since  $V_{12}$  energizes the squelch relay when its grid is slightly positive. Capacitor  $C_2$  provides a delay action to prevent interruption of the audio signal during short pauses in the speech. Resistors  $R_7$  and  $R_8$  are used to pre-charge  $C_2$  when the squelch relay is not operated.

The authors acknowledge the contributions of J. H. Durrer of Coles Signal Laboratories, also W. G. Klehfoth and M. W. Caquelin.

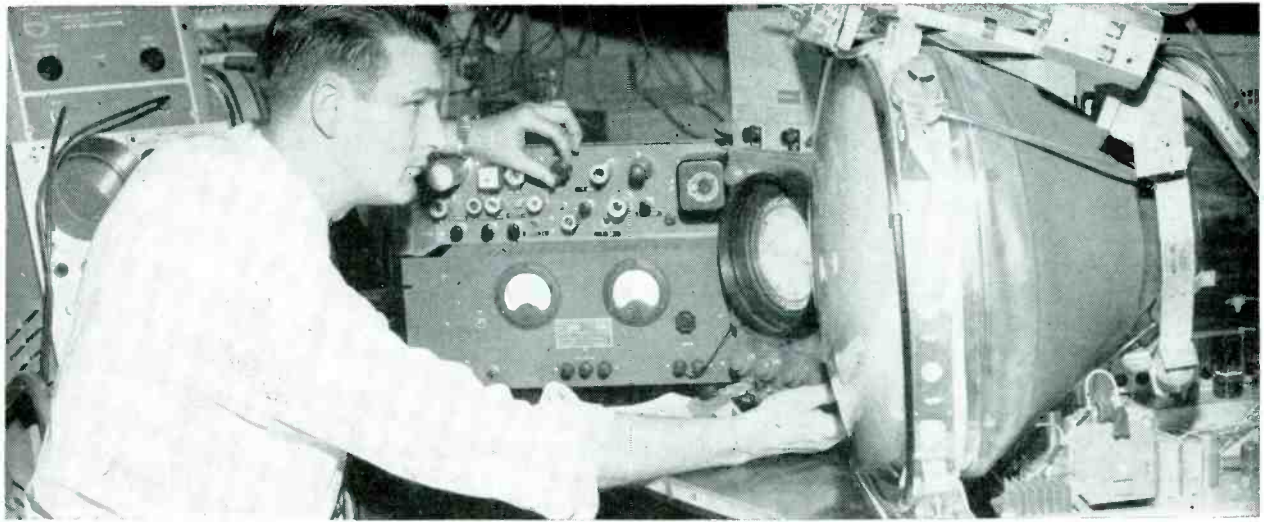

Color set is checked out with signals from flat-field generator. Receiver controls are not altered during test

# Flat-Field Generator Speeds Color Tv Testing

By RICHARD W. COOK

*Advance Development Color Laboratory  
Television-Radio Division  
Westinghouse Electric Corporation  
Metuchen, New Jersey*

**SUMMARY** — Experimental work on color television systems is facilitated by generator that provides composite color video signals of any hue and saturation as well as luminance signal that is variable from black to white. Except for presenting only one color at a time, instrument can replace many functions of encoder or colorplexer in factories, laboratories and broadcast stations

**C**OLOR RECEIVER circuit and crt phosphor purity tests usually require changing the receiver controls from their normal operating settings for flat-field analysis of each of the three primary colors.

## Technique

Development of a flat-field color-signal generator with variable saturation and variable phase from 0 to 360 deg permits making purity checks of all three primary colors without altering the receiver controls. The desired primary is simply injected into the receiver; a quick oscilloscope check insures the proper function of the receiver chroma demodulators so the desired primary color information is always

fed to the correct electron gun.

When analyzing color picture tubes, small phosphor nonuniformities causing areas of difference in light output may not be readily apparent when observing one of the primary colors. Using a complementary color, any nonuniformity of this nature shows up as a difference in hue as well as light output in that area because of the adding of the primary colors to obtain this complementary color. This difference in hue provides a more sensitive observation than simply observing light output, thus providing a more accurate analysis of the picture tube.

Designed for use with existing laboratory, broadcast or manufac-

turing facilities, the generator requires external composite-sync, burst-flag and subcarrier signals.

## Circuit

Figure 1 is the block diagram and Fig. 2 the circuit diagram of the generator.

Video amplifier  $V_{14}$  provides a short rise time and sufficient gain to gate balanced chroma modulator  $V_2V_3$  through phase splitter  $V_{1B}$ ; equal and opposite polarity gating pulses are fed to the suppressors of  $V_2$  and  $V_3$ . Subcarrier is applied to the grid of  $V_3$ , the grid of  $V_2$  being grounded.

With no signal into  $V_2$  there will be no output if the gating pulses are equal in amplitude and sym-

metrical in rise time. However, since there is an inherent clamping action by the suppressor if  $V_2$  is driven beyond cutoff, the two gating pulses will not be completely symmetrical due to the finite rise-time of the gating pulse. This non-symmetry causes small spikes on the leading and trailing edges of the blanking pulse.

While these spikes may be neglected, their amplitude is further reduced by adjusting the level of the gating pulses so  $V_2$  just reaches cutoff. The two opposing pulses are then more identical in shape, thus decreasing the spike amplitude. Balancing potentiometer  $R_1$  and the 1.5 to  $7\mu\text{F}$  trimmer reduces these spikes.

The output of the modulator is developed across tuned and damped transformer  $T_1$  that limits the bandpass to about 2 to 5.5 mc.

### Flat-Field Production

One feature of this unit is variability of the phase of the subcarrier chroma signal with respect to that of the burst, thus producing any color or signal as a flat field of video information.

Amplifier  $V_{4A}$ , driven by the output of the chroma modulator, drives  $T_2$  which provides two

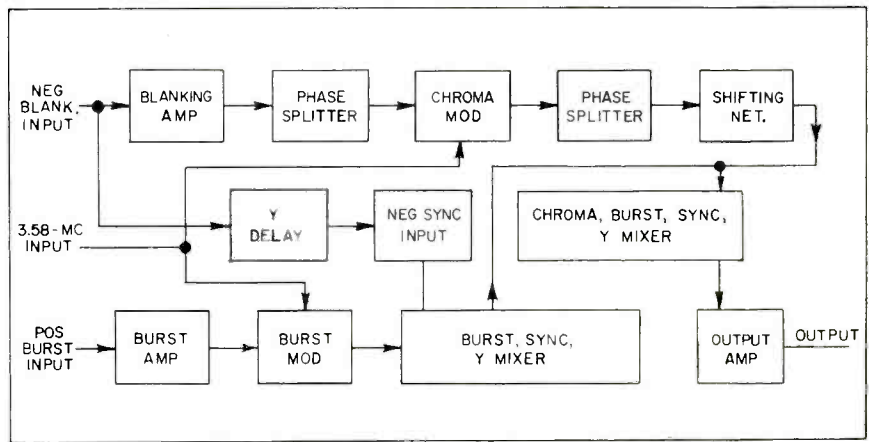

FIG. 1—Block representation of flat-field color signal generator

chroma signals 180 deg out of phase with each other. These two outputs are injected into the phase shifting network at points *A* and *B* on the continuously-variable potentiometer.

The values of the resistors and capacitors provide 90-deg phase shifted equal-amplitude signals at *C* and *D* on the potentiometer.

By vectorially adding the voltages across the various resistor and capacitor combinations, the amplitude of the output chroma signal will be found to be equal at points *A*, *B*, *C* and *D*; these will be the maximum values of sub-

carrier. The minimum values, approximately 3 db lower, will be found half-way between these four points. This variation in output is not objectionable since amplitudes of the subcarrier and luminance signals must be changed for each change of phase to produce a standard chrominance signal.

### Burst Pulse Generation

The burst pulse is generated in a manner similar to the chroma information. It differs in that the modulator is biased off except during the burst interval. A positive burst-flag pulse applied to grounded-

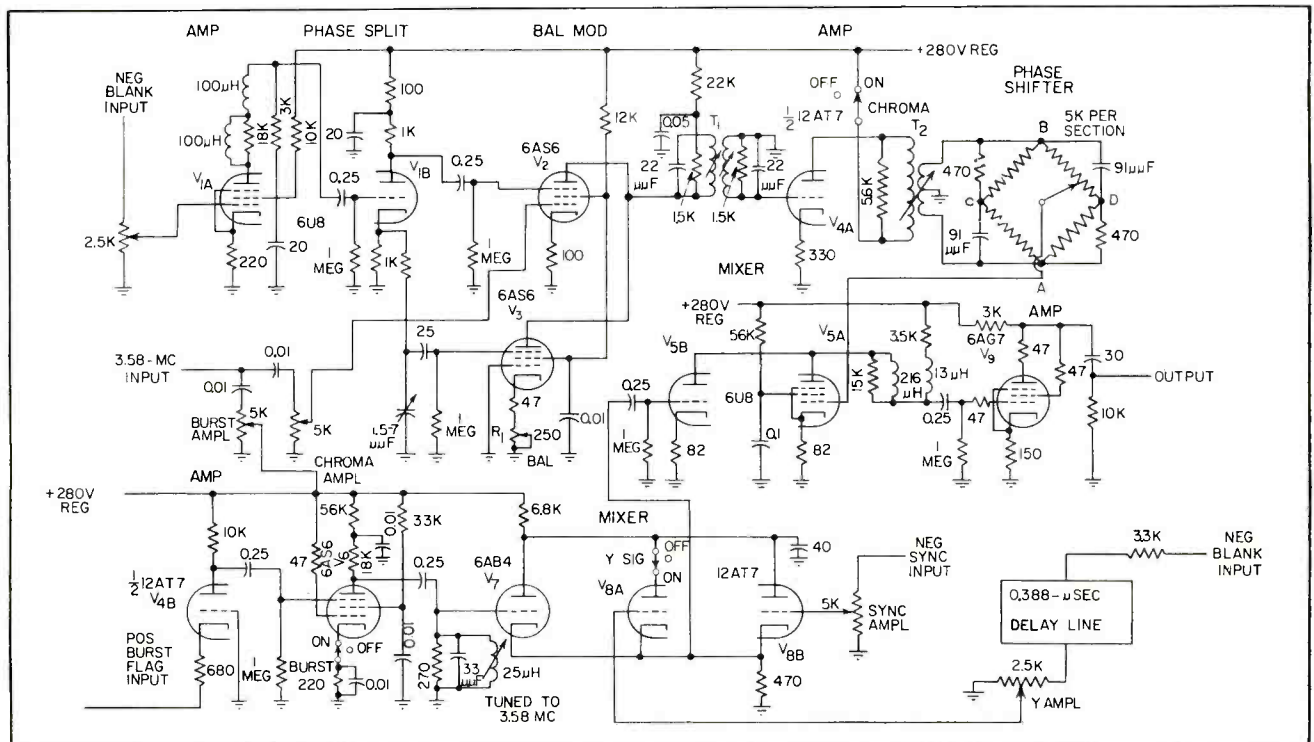

FIG. 2—Four-section continuously-variable potentiometer phase shifts chroma signals to provide variable hues

grid amplifier  $V_{gn}$  gates the modulator in the proper phase.

The burst modulator is not balanced; this results in differentiation of the leading and trailing edges of the burst flag being added to the burst signal. The heavily damped circuit across the output of this modulator reduces the amplitude of the differentiated spikes to a satisfactory level.

The burst, sync and Y signals are mixed in a cathode-coupled mixer  $V_7$ ,  $V_{8A}$  and  $V_{8B}$ . The burst signal is applied to the grid of  $V_7$  and the sync signal is applied to the grid of  $V_{8B}$ . The Y signal is received through a delay line so as to match the chroma signal with which it will be mixed. This signal is fed to the grid of  $V_{8A}$ . The three triodes are used as cathode followers with a common load resistor.

### Composite Signal

The chroma, burst, sync and Y mixing stage,  $V_8$ , contains the various signals of the system into a composite color signal. The output of the phase shifting network is applied to the grid of  $V_{8A}$  while the output of the burst, sync and Y mixer is fed to the grid of  $V_{8B}$ .

The composite signal is applied to the grid of power output amplifier  $V_9$ . This is a constant-current amplifier designed to be used as a plate-loaded line driver working into a terminated 75-ohm transmission line to reduce hum on the receiving end of long lines.

### Construction

The unit was built on a standard chassis, 5 by 5 by 17 in. wide. Parts placement is not critical beyond the normal practice of good layout design.

Transformer  $T_1$  consists of two identical windings bifilar wound with #38 enamelled cotton covered wire on a  $\frac{1}{4}$ -in. coil form. The coils should be wound so that the coupling may be variable for alignment purposes. Transformer  $T_2$ , also bifilar wound on a  $\frac{1}{4}$ -in. form, is tuned by a single slug and need not be shielded.

### Initial Alignment

The circuits including  $T_1$  and  $T_2$  should be tuned broadly to 3.58 mc with a bandpass of approximately

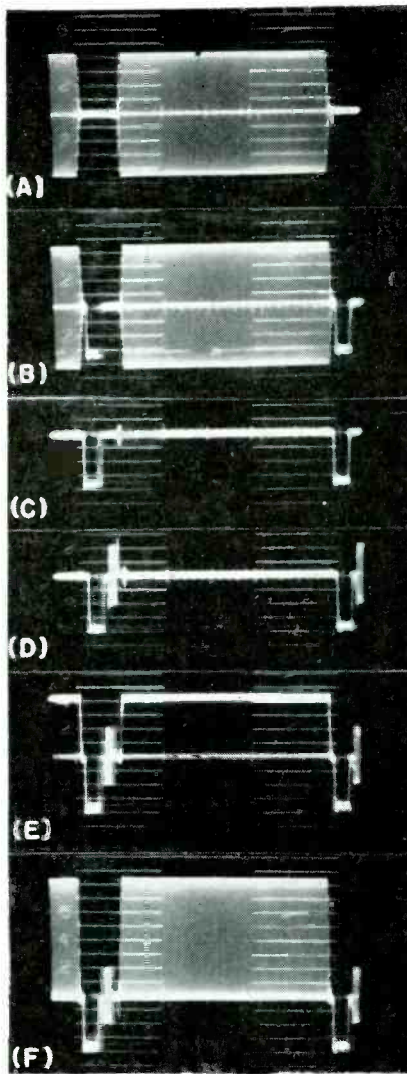

FIG. 3—Typical output waveforms for initially aligning signal generator

3.5 mc. The heavily damped tuned circuit at the grid of  $V_7$  should be peaked at 3.58 mc. It may be necessary to temporarily remove the 270-ohm damping resistor to make this adjustment.

To place the unit into operation, the following procedure is suggested. Monitoring the output with a wide-band oscilloscope, increase the chroma amplitude to give 0.88-v peak-to-peak output with all other controls in their minimum gain position. Inject blanking into the system until the chroma signal just reaches zero during the normally blanked region of the signal. The desired results are illustrated in Fig. 3A. The sync amplitude is adjusted, as in Fig. 3B, to be 0.4 v.

The small spikes mentioned previously can be seen by reducing the chroma level to zero Fig. 3C.

Their amplitude may be minimized by adjusting  $R_1$  and  $C_1$ .

A complete video chrominance signal producing a green field may be obtained by increasing the burst amplitude to 0.4 v peak-to-peak (Fig. 3D), raising the luminance level to 0.44 v (Fig. 3E) and advancing the chroma signal until it becomes tangent to the baseline as illustrated in Fig. 3F. This signal should then be applied to a vector-display system or phase-measuring device and the phase of the chroma information determined with respect to the burst. Rotating the phase control to obtain a phase representative of a green color and then readjusting the chroma amplitude slightly if necessary complete the adjustments.

### Applications

The preceding adjustments are only required in the initial alignment. After the unit is put into operation, the only adjustments necessary will be those determining the phase and amplitude of the chroma information and the amplitude of the luminance portion of the signal.

By substituting a square-wave for the standard blanking pulse a single color bar, a luminance signal with a very short rise time or chroma over any desired portion of the scanning lines, can be formed while leaving the remainder of the line in the black region.

This instrument can perform many functions of an encoder or colorplexer supplying the laboratory or broadcast station with an additional source of a color signal. It is especially helpful when only a color-difference or an I or Q signal is desired for alignment of decoding systems. These signals are obtainable from most encoders only when the encoder is operated in a manner that deviates from its normal condition. Where an encoder is shared by a development laboratory and a factory actively engaged in assembly line production, a change from the normal color signal is usually out of the question.

Acknowledgment is due K. E. Farr for his assistance, encouragement and contribution to the development of this unit.

**SUMMARY** — Moving target indicator spots and counts bacteria colonies randomly distributed over a flat surface. Spot signals from particles less than 100 microns in diameter are received from cathode ray tube and stored in a 1,000  $\mu$ sec delay line. Video circuit compensates for spot-to-background density and an anticoincidence circuit determines the correct count delivered to a high-speed recorder. System has wide-range application in medical laboratories

By H. P. MANSBERG, Y. YAMAGAMI and C. BERKLEY\*

*Technical Products Engineering  
Allen B. DuMont Laboratories, Inc.  
Clifton, New Jersey*

# Spot Scanner Counts

**B**ACTERIAL COLONY COUNTING is performed daily in hundreds of biological, dairy, food industry and water testing laboratories. In this technique, a diluted sample of the material to be assayed is cultured in a Petri dish. After incubation, bacteria cells in the culture grow into colonies large enough to be visible. These colonies are counted visually with the aid of a

magnifier and a uniform light source. The count density may vary from a few to over a thousand and so counting accuracy depends rather heavily on human factors.

## Automatic Counter

The bacteria colony counter, described in this article, developed under the sponsorship of the U. S. Army Chemical Corps, provides a scanning method for counting such colonies that is faster and more consistently accurate than the tedious visual measurements performed by laboratory technicians.

In any optical system of scanning, adapted to count random size particles, it is necessary to compensate for the many intercepts a small spot or aperture produces for a single particle. Various methods of solving this problem have been used and reported by other workers.<sup>1, 2</sup>

## Tangency Detection

A pulse storage system, similar to a radar moving target indicator, was designed to overcome the difficulties of multiple intercepts. In mti radar, pulses produced by each scan are stored in an ultrasonic delay line and compared in a cancellation circuit which produces a residue signal. The signals, displayed on the radar indicator, show only the targets in motion.<sup>3</sup>

The delay used in the system stores all pulses on each scan line

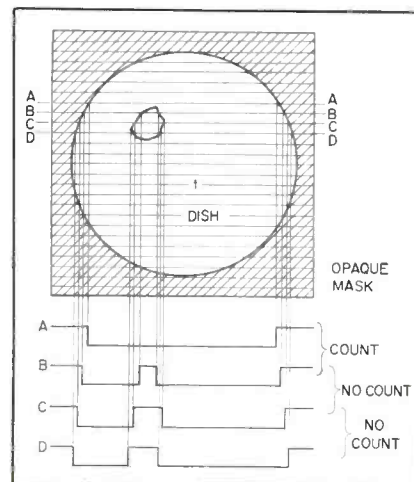
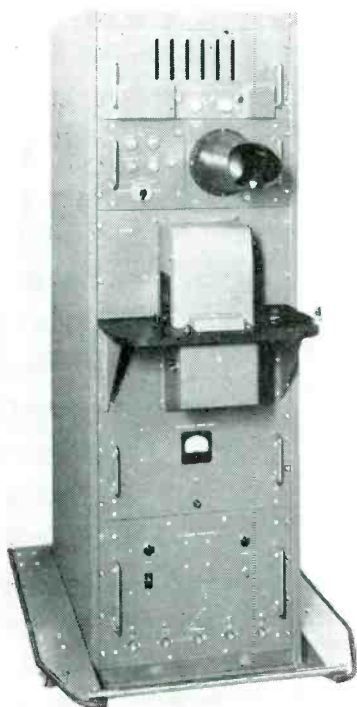

FIG. 1—Tangency detection by signal delay and anticoincidence. The system chosen counts organic and inorganic particles as they are scanned

and compares them in an anticoincidence circuit, with pulses on the next consecutive scanning line. A time overlap logic circuit produces an output pulse only when an input pulse arrives at just one of its three input channels.

Tangency detection by signal delay and anticoincidence is illustrated in Fig. 1. The traversal time of the scanning spot is equal to time  $t$ , the delay time, so all pulses are reproduced exactly one line later. Scanning line A does not intercept the particle and does not produce a pulse. Scanning line B

\* Now with RCA Research Laboratories



Front view of the electronic particle and bacteria colony counter



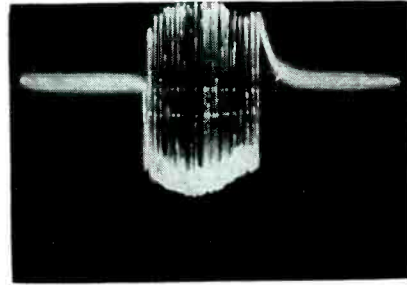
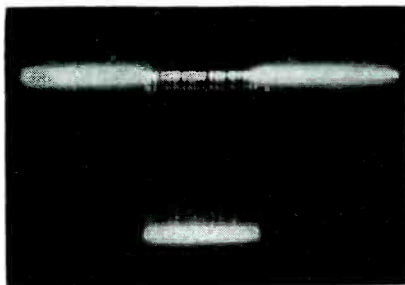

Left to right are the output waveforms of phototube, video-compensator and amplitude discriminator as system counts colonies

# Micron-Sized Particles

intercepts the particle and produces a pulse, which is fed to the anticoincidence circuit. Simultaneously, information from scan line *A* appears at the anticoincidence circuit and, because it contains no overlap, pulse *B* produces a count.

On scan line *C* a slightly wider pulse is produced. However, the *B* line pulse also appears at the output of the delay line at such time as to provide a time overlap with the pulse produced by line *C*. Therefore, a count is not registered. Similarly, the line-*D* pulse is overlapped by the delayed pulse of line *C* and again no count is registered. The next line does not intercept the particle and no pulse is produced.

## Optics

In the optical system for the line-to-line memory, shown in Fig. 2, a high-quality objective lens images the raster on the Petri dish. The condenser lenses image the exit pupil of the objective lens on the type 6292 multiplier phototube cathode, preventing the motion of the scanning spot from producing any perceptible motion of the illuminated area on the phototube. This minimizes noise or other signals produced by cathode surface nonuniformities.

The size of the scanning spot produced on the high-resolution crt is approximately 100 microns,

imaged at 1 to 1 object-image ratio on the Petri dish. The edge of the dish is masked so that protrusions on the molded edge of the dish or the meniscus of the agar do not produce spurious signals because of refraction.

Scanning pulses are idealized in Fig. 1. In actual scanning, the pulse shape is governed by phos-

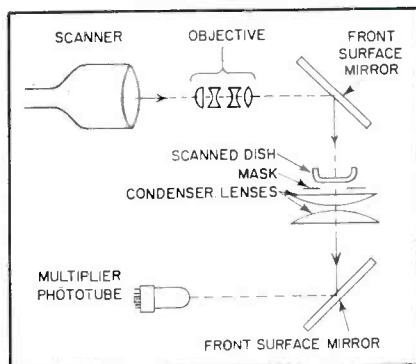

FIG. 2—Optical system uses a high-resolution scanner and high-quality objective lens to image the raster on the dish that contains particles that are scanned electronically

phor persistence, spot shape, optical density and shape of the particle, density of the background materials and the system optics. Amplitude of the actual pulses vary and the curved waveshape at the bottom baseline is caused by the varying density of the culture media and nonuniform light trans-

mission of the optical system.

In any lens system, the transmission of off-axis rays will decrease with the fourth power of the cosine of the angle that these rays make with the optical axis. In a wide angle system, a considerable change in light transmission occurs. Added to these difficulties are noise factors of phototubes, non-uniformities in crt phosphors, dust in the optical system or contamination of the culture media. The circuitry compensates, in part, for some of these difficulties.

## Complete System

Figure 3 is a block diagram of the automatic colony and particle counting system. The magnetic-deflection system for the type K1429P15 crt is synchronized by pulses from a high-speed standard commercial electronic counter.

The synchronizing pulses are 1 kc for the horizontal and 1 cps for the vertical, producing a 1,000 line raster with a vertical frame rate of 1 cps. Relatively low-speed scan rates reduce bandwidth requirements and need for phosphor correction. Since the electronic counter provides its own time base, it is convenient to use a one-second scan period and timing pulses from the time-base generator to synchronize the sweep circuits.

The crt phosphor and faceplate are especially fabricated to avoid

optical defects. Full protection is supplied to the crt to prevent damage in the event of scanning circuit failure.

The scanner protection circuit derives signals from the output of the magnetic sweep. These signals operate a relay which causes the 20-kv anode supply to shut down and the focusing current in the focus coil to cease in the event of sweep circuit failure. Multiplier phototube signals are transmitted by a cathode follower to a video compensation and Schmitt-trigger circuit.

### Video-Compensation

The pulse shapes derived from scanning different types of cultures and particles vary greatly and it is necessary to operate on these waveforms before reliable counts are obtained. The video compensation circuit senses the density of the background material upon which the particles or colonies exist. The circuit is essentially a fast acting d-c restorer which rapidly changes the base level of the pulse depending upon the opacity of the background.

In the photograph of the waveform of the phototube output, the black level is the horizontal line at the top of the waveform and the white or background level is the curved waveshape at the bottom. Video compensation elevates the pulses to the black level or beyond so that the amplitude discriminator may be set for sensitivity only to pulses approaching this black level.

In the photograph of the output of the video compensation circuit, the baseline curvature has been partially corrected and the pulses reach an amplitude beyond the horizontal line or the black level.

### Amplitude Discriminator

The amplitude-discriminator detects the signal just below the black level and resets approximately 3v below the firing level. These two levels are shown by bright marks superimposed on the pulses. Triggering and resetting action of the discriminator circuit reduces noise so the final pulses operating the delay line and the anticoincidence circuits appear as shown in the

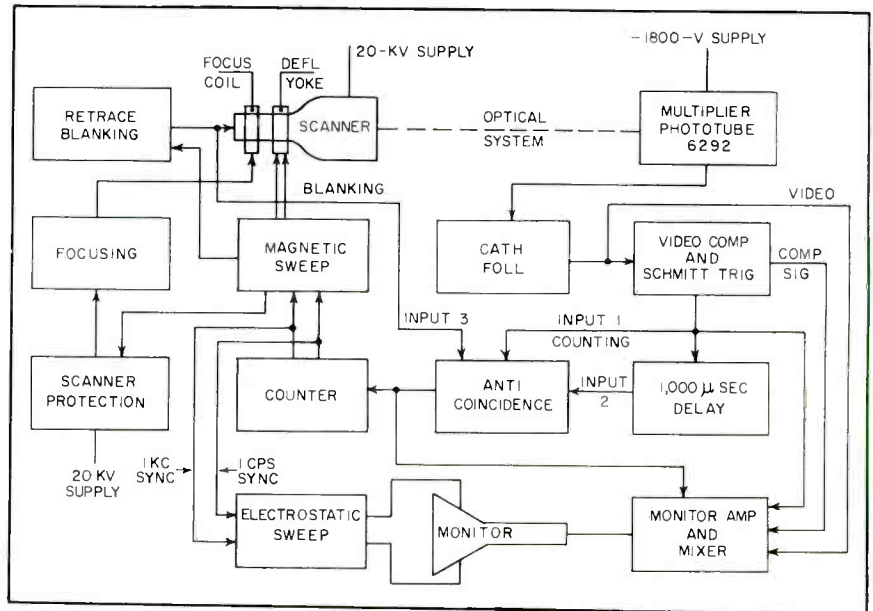

FIG. 3—Block diagram of the automatic particle and bacteria colony counter. The delay or memory system stores pulse counts for each line scan and compares them, in the anti-coincidence circuit, with pulses on the next consecutive scanning line

waveform of the amplitude discriminator output pulses. All pulses have uniform amplitude and rise and fall times, simplifying delay-line design and anticoincidence circuit functioning. The photometric effect produced by the circuit is one of converting objects having non-uniform density to uniformly opaque objects.

### Delay Line

The 1,000- $\mu$ sec delay, exactly the time of a single horizontal traverse,

is supplied by a fused quartz acoustic delay system. The 1,000- $\mu$ sec delay line is fed to the anticoincidence circuit which produces output counting pulses in accordance with tangency detection.

Waveforms from the phototube, the video compensation circuit and the amplitude discriminator can be monitored and a picture display showing an image of the scanned field, which can check the counted particles, is provided. The monitor crt is electrostatically deflected by sweep circuits and synchronized by the 1-kc and 1-cps time-base pulses of the electronic counter.

### Circuits

The phototube circuit schematic is shown in Fig. 4 and the video compensating amplitude discriminator and delay line circuits are shown in Fig. 5. To avoid possible restoration distortion of the scanned signal, d-c coupling is used from the photocell through to the output of the amplitude discriminator.

Phototube output is fed to a d-c coupled amplifier whose cathode is connected to a diode detection circuit. Negative-going signals, detected by these diodes, supply a bias voltage at the grid of cathode follower  $V_{s.c.}$ . This bias voltage is proportional to the amount by which the negative going or white por-

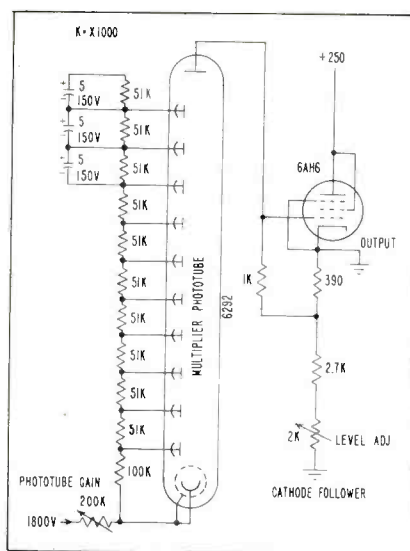

FIG. 4—Multiplier phototube signals are transmitted by a cathode follower to the video video-compensation and Schmitt trigger circuit shown in Fig. 5

tion of the signal exceeds a fixed amount determined by  $R_1$ . This bias signal is fed continuously to the second grid of amplifier  $V_1$  to adjust its output level according to the background density of the culture medium.

#### Discriminator

The output of  $V_1$  is coupled directly to amplitude discriminator circuit,  $V_4$ . The discriminator output goes directly to one channel of the anticoincidence circuit through amplifiers  $V_{6B}$  and cathode follower  $V_6$ . The signal is inverted at the plate of  $V_{6B}$  and fed to the modulator. The fused-quartz delay line operates at a carrier frequency of 15 mc, supplied by the crystal oscillator at  $V_7$ . Driver amplifier  $V_8$  is grid bias modulated by the output of modulator  $V_{3A}$ .

The 15-mc modulated carrier is transmitted into and out of the quartz input and output transducers on the delay line. At the bandwidth required, about 2 mc, the signal is attenuated at the output of the delay line by approximately 100 db. Tuned amplifier  $V_9$  amplifies this signal and couples it to phase splitter  $V_{10}$ .

The carrier is demodulated by diode detectors and coupled to video amplifier  $V_{11A}$ . The output passes through the cancelling channel of the anticoincidence circuit through cathode follower  $V_{11B}$ . An adjustable, thermostatically controlled oven for the delay line stabilizes and adjusts the operating temperature of the fused quartz for a velocity of propagation, exactly in accordance with the 1,000  $\mu$  sec delay required.

#### Anticoincidence

In the anticoincidence circuit of Fig. 6, the undelayed signal output of the amplitude discriminator circuit marked input 1, is coupled to peaking amplifier  $V_{14}$ . This amplifier provides sharp pulses at both the leading and trailing edges of the pulse produced by the scanned particle and trigger circuit. The leading-edge pulse is amplified by  $V_{15B}$  and coupled by cathode follower  $V_{16A}$  to a diode section of  $V_{16}$ .

Memory capacitor  $C_1$  charges to about 10 volts. This charge cannot leak off except through the high

back resistance of the discharge diode section of  $V_{16}$ . The capacitor charge appears at one of the grids of the gating mixer tube  $V_{18}$ . The trailing edge pulse is amplified by  $V_{17B}$  and fed through cathode follower  $V_{17A}$  to the other control grid of  $V_{18}$ .

Gating tube  $V_{18}$  is biased so the voltage on one of the two control grids cannot turn the tube on. However, when the memory ca-

cannot conduct. This is the method of cancellation. A duplicate cancelling channel, input 3, receives horizontal and vertical flyback gating pulses and discharges the memory capacitor at the end of each line scan.

#### Check Marks

The picture monitor enables the operator to see whether the scanning and counting circuits are func-

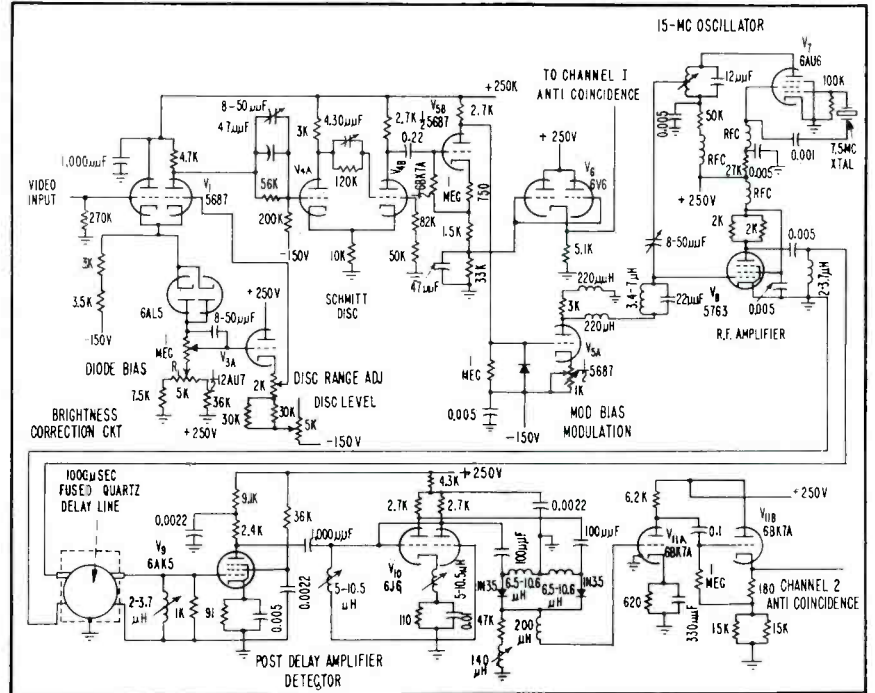

FIG. 5—The video compensation circuit senses the density of the background material upon which the particles or bacterial colonies exist

capacitor is charged and the trailing-edge pulse reaches the other control grid, the tube conducts producing a sharp negative pulse at its plate. This is the counting pulse, amplified by  $V_{18A}$ , coupled to cathode follower  $V_{19B}$ , and passed to the counter.

The output of the delay line is coupled through input 2 to cathode follower  $V_{13}$  and d-c restorer  $V_{12}$  to the discharge diode. A pulse at the output of the delay line appears at the cathode of one of the diodes of  $V_{16}$ , causing it discharge memory capacitor  $C_1$ .

If an input-2 pulse appears at any time after the memory capacitor is charged and before the trailing edge pulse of input 1 appears, then the memory capacitor is discharged and the gating tube  $V_{18}$

tioning properly. A bright check mark or pip on the image indicates each object detected and counted by the anticoincidence circuit. Thus the monitor image shows whether all objects in the field were counted.

#### Effects of Particle Shape

One limitation of tangency detecting for counting is that if the object shape has a reentrant or U-shaped profile, oriented so that the first intercepting line intercepts both legs of the U, two counts will be produced. Except for the reentrant profile type of shape, the counting system is relatively insensitive to size or shape of the object. The system is not confused by objects inside of other objects provided there is a clear

space between them of at least one scanning line.

### Random Orientation

When two objects overlap in a horizontal direction they will present two tangent points to the scanning lines and produce two counts. However, in vertical overlap, perpendicular to the scanning line, the system will register only one count where two particles exist. This can produce a substantial error when colony or particle populations are high and distributed so that a large number of contiguities exist. Statistical correction factors can be used to compensate for these errors.

### Counting Accuracy

The particle detector produces counts within 3 percent of those obtained by electrical probe methods when the concentrations or populations are about 100 colonies on a plate. As the population density of culture plates increases, the contiguity, increases and the machine consistently produces more count errors.

This error condition is also frequently true of technician counting where for high population densities the count is often estimated.

It is sometimes possible to count bacteria at an earlier stage in incubation. The smaller the colonies,

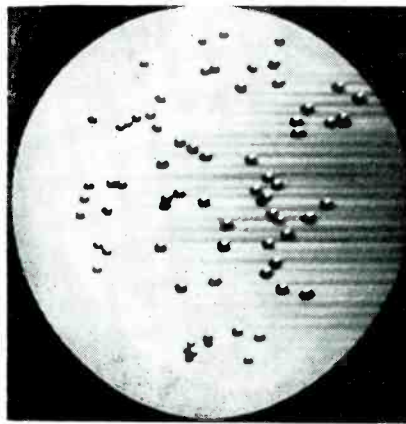

Monitor picture of counted colonies of bacteria as seen with equipment

the lower the probability is that colonies will be in contact.

Details on count accuracy and test results are found elsewhere.<sup>4</sup>

### Applications

The advantages of the particle counter lie in the freedom from human errors, in the ability to gather large masses of data in a short time and the ability to analyze much larger and therefore more representative samples.

Any objects that can be placed in a Petri dish may be counted provided they are large enough to be resolved about 0.5 mm diameter and they have sufficient optical density, about 0.3.

Particles which differ sufficiently

in size may be counted separately by defocusing and subtracting or by refined circuit techniques. Differential counts of colored particles may be made by using color filters in the optical system. By suitably inverting the photocell signal, the holes in an object or hyaline phage colonies in an otherwise opaque plate may be counted. Circuitry and equipment are under development to enable analysis of all such information

Scanning techniques are applied to differential blood counts; specific cell populations in tissue cultures; marine and other media; grading of dispersion and particulate matter; automatic scanning of tissue sections and exfoliated cells for malignancies; radiation damage evaluation on a per cell basis; pollen counts; testing of micron filters and oil filters; fermentation controls; spray and aerosol generator testing and autoradiograph grain counting.

### Sample Preparation

Accuracy of the results depends on sample preparation techniques. Just as the development of the electron microscope required the evolution of special sample techniques peculiar to its requirements, so the flying-spot scanner will stimulate a search for superior methods of sample preparation.

The counting speed provided by flying spot scanning and the type of circuits shown in this article are ultimately capable of scanning and counting up to one million particles per second.

The development work leading to the design and construction of this instrument was made possible by the U. S. Army Chemical Corps at Fort Detrick, Maryland. The authors appreciate the valuable technical assistance contributed by Mr. Nelson E. Alexander of the Chemical Corps.

### REFERENCES

- (1) C. Lagercrantz, On the Theory of Counting Individual Microscope Cells by Photoelectric Scanning, An Improved Counting Apparatus, *Acta Phys Scand*, 26, Supp 93, 1953.
- (2) F. Roberts and J. Z. Young, The Flying Spot Microscope, *Proc of BIEE*, Part 111a, April-May 1952.
- (3) B. Chance, R. Hulizer, F. Williams and E. MacNichol, "Electronic Time Measurements", *MIT Rad Lab Series*, Chap 12, 20. McGraw-Hill Book Co. Inc., New York, 1949.
- (4) H. P. Mansberg, An Automatic Particle and Bacterial Colony Counter, *Sci*, Oct. 1957.

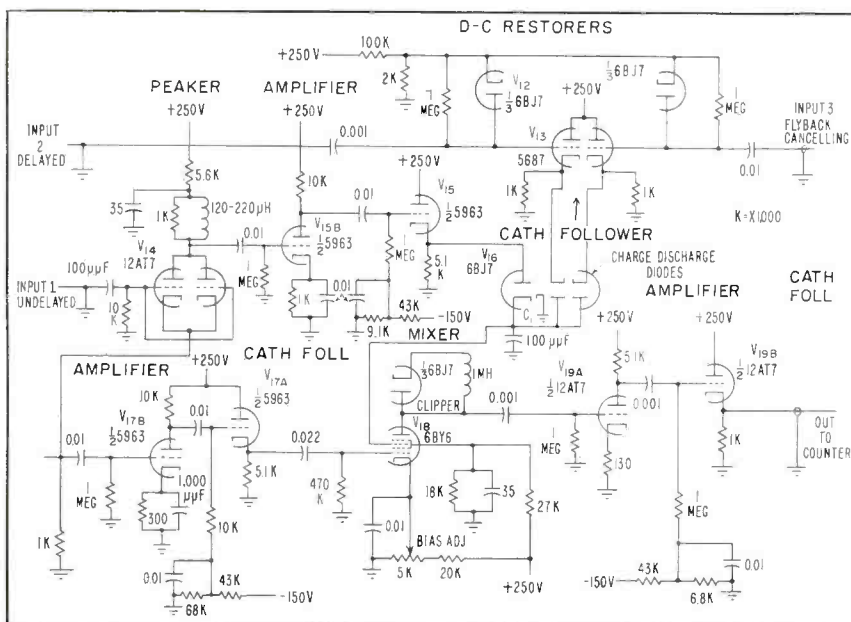

FIG. 6—Anticoincidence circuit. Charge on memory capacitor  $C_1$  determines whether gating tube can conduct hence it can be used to cancel signals

# Transistor Relays Have Low Idling Current

By D. W. R. MCKINLEY

Radio and Electrical Engineering Div.  
National Research Council  
Ottawa, Ontario, Canada

**SUMMARY** — Electronic relays of remote-control devices operate electro-mechanical relays requiring 2 or 3 watts; consume few microamperes when idling. Circuits for c-w audio and pulsed-video control signals are shown

**R**EMOTE radio control equipments require receivers which will run continuously with the lowest possible standby battery drain and which will deliver, on demand, 2 or 3 watts of power to a rugged and reliable heavy-current relay to turn on gasoline-electric generators or other equipment.

This article describes two types of transistor relays which can be used at the output end of the receiver to convert the signal waveform into useful d-c power. The control signal may be a carrier modulated at 1,000 cps or it may consist of short pulses from a microwave transmitter.

## Basic Circuit

The basic circuit shown in Fig. 1 follows a cascade complementary arrangement. Input transistor,  $Q_1$ , should be of silicon to ensure that its idling current ( $I_{co}$ ) at zero bias will be about 1 or 2  $\mu$ a. A germanium transistor can be used with  $-1.5$ -v base bias, but the  $I_{co}$  will usually be higher than that of the silicon types with no bias.

Input transistor,  $Q_1$ , acts as a single-ended class-B amplifier for the signal voltage. The  $2\text{-}\mu$ f capacitor from collector to ground filters the half-sine wave output of  $Q_1$ , and provides a smooth d-c bias for  $Q_2$ .

The effective input impedance is about 8,000 ohms and an input signal of 2 to 3 vrms will develop 8 v d-c across a 15-ohm output load in the emitter circuit of  $Q_2$ . Power gain of the relay is 30 to 40 db, depending on the input level. Effi-

ciency of the output transistor varies with the signal level and ranges up to 70 percent.

A 6-v d-c 0.5-amp dpdt relay operates satisfactorily when substituted for  $R_L$ . Idling power is  $\frac{1}{2}$  mw, compared to 4 w delivered power when the relay trips.

## Pulse-Sensitive Circuit

When pulses of 1 or 2- $\mu$ sec duration are used for signaling, the circuit of Fig. 1 is not satisfactory and a pulse-stretching technique should be used. In Fig. 2, feed back transistor  $Q_3$  and network  $R_1$ ,  $R_2$ ,  $C$  are added for this purpose.

The rising edge of an input positive pulse turns on  $Q_1$ ,  $Q_2$  and  $Q_3$ , in that order, and the regeneration around the loop speeds up the action. The transistors remain turned on full until the charge on  $C$  is dissipated causing a sharp fall in the transistor currents.

The width of the square wave produced across  $R_L$  may be controlled by varying either  $R_1$  or  $R_2$ . The duty cycle is adjusted to be as high as possible (up to 70 percent ON time can be obtained) at the lowest pulse repetition frequency used; for higher repetition frequencies the relay will simply count down.

## Switching Efficiency

Since the transistors are acting as switches in Fig. 2, efficiencies are higher than in the circuit of Fig. 1. For example, with 12 v on the collector of  $Q_2$  and 50 percent duty cycle, a 10.5-v square-wave is developed across a 15-ohm load, with an average emitter current of 340 ma. Average d-c output power developed across  $R_L$  is then 3.6 w.

The efficiency of  $Q_2$  is nearly 90 percent and is independent of signal level since the transistor is either full on or shut off.

A pulse amplitude of 1 v is sufficient to trigger the relay. A 6-v d-c relay may again be used in place of  $R_L$ . When zero-bias silicon transistors were used, total idling current was less than 5  $\mu$ a, but useful d-c power was limited to 0.5 w with the transistors available.

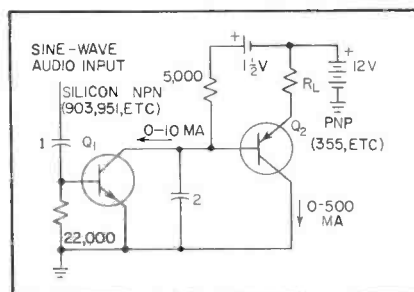

FIG. 1—Relay operates on c-w audio input

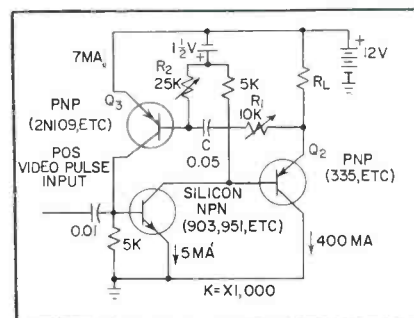
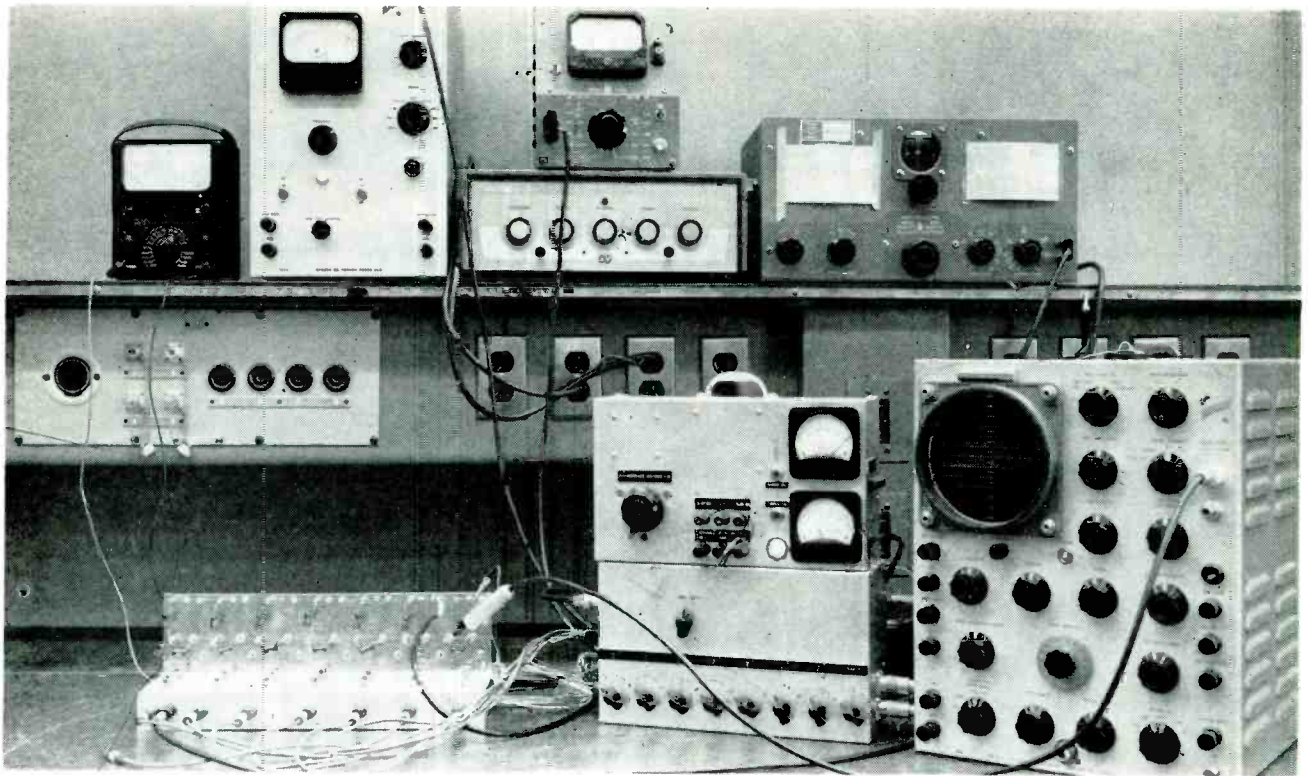

FIG. 2—Pulse-stretching technique adapts circuit for pulsed-video input



Complete test setup shows the digital-analog converter at the lower left with dynamic input simulator and power supply next to it

# Digital-Analog Converter

By H. N. PUTSCHI, J. A. RAPER and J. J. SURAN

*Electronics Laboratory  
General Electric Co.  
Syracuse, N. Y.*

**E**LECTRONIC DIGITAL computers use digital systems throughout their arithmetic units, but the outputs required are often of an analog form. The digital-analog conversion is sometimes done in an electromechanical form as in shaft position servos.

Transistors were used in preference to vacuum tubes in the equipment to be described because of their reliability, low power consumption and small size. The converter is required to convert seven bits of binary information to 128 analog steps in amplitude of a 400-cps sinewave and convert an additional binary bit to requisite phase information.

These functions must be performed within a 4 millisecond sampling period, occurring at an average repetition rate of 20 cps. Input information is received in

parallel form from a shift register and must be stored in the digital-analog converter between sampling period. A binary ZERO is represented by a  $-30$  volt signal at the respective input terminal, a ONE by zero volts. The converter output works into a high-impedance load and a full-scale output of 20 volts peak to peak must be supplied. The equipment must operate over a temperature range from  $-50$  C to  $+85$  C.

## Gates

The circuit diagram of the complete digital-analog converter is shown in Fig. 1. To keep the current drain on the gate pulse signal within the permissible limits, a gate pulse current amplifier, common to all eight bit-converters, was used. Its current gain is in excess of that required to keep the drain

on the gate-pulse source within the permitted limits. Diodes  $D_5$  and  $D_6$  provide correct d-c levels for the a-c coupled gate pulse.

Seven bit-converters have identical circuitry. Transistor  $Q_7$  plus associated circuitry constitute a sample gate circuit. It is connected as a common-emitter amplifier and is normally cut off by its  $-16$  v bias battery. If a ZERO ( $-30$  v) is read into the gate from register connection  $X_1$ , the gate transistor is kept cut off even if the positive gate pulse arrives.

The gate pulse is also connected to the collector side of the gate transistor through a 33,000-ohm resistor and will appear at the gate circuit output with an amplitude of about 8 volts if transistor  $Q_7$  is not conducting. Thus a ZERO read into the register results in a positive output pulse from the gate

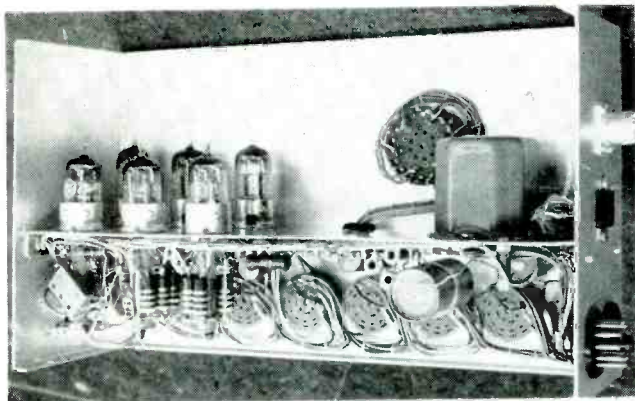

Dynamic input simulator contains 400-cps oscillator, 25-cps gating circuit and output cathode followers to drive bit converters

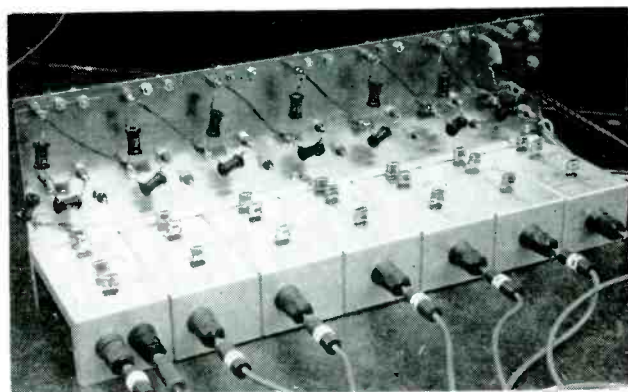

Rear view of converter unit showing modular construction. Left module also contains the gate-drive amplifier

**SUMMARY** — When high-speed or environment rule out mechanical converters, purely electronic units must be employed. This transistorized converter changes eight binary bits, received in parallel from a shift register, to 128 steps in amplitude of a 400-cps sine wave. One binary bit is used to obtain phase information. Operation is performed within a 4-millisecond sampling period occurring at an average rate of 20 cps

## Provides Storage

circuit. If a ONE (0 v) is read into the gate circuit from the register,  $Q_7$  still remains cut off in the absence of the gate signal. In the presence of the gate signal the

Table I—Resistance Matrix Outputs

Digital Input			Analog Output
$E_1$	$E_2$	$E_3$	$E_0$
0	0	0	0
1	0	0	$\frac{1}{8}$
0	1	0	$\frac{1}{4}$
1	1	0	$\frac{3}{8}$
0	0	1	$\frac{1}{2}$
1	0	1	$\frac{5}{8}$
0	1	1	$\frac{3}{4}$
1	1	1	$\frac{7}{8}$

transistor is driven into saturation.

The collector circuit thus becomes a low-resistance path to ground. Since the collector voltage between gate pulses is about +8 volts, there will be an 8-volt negative pulse at the output of the gate circuit for the duration of the gate signal. To avoid accumulative charging of the 1- $\mu$ f coupling capacitor and thereby losing the correct 8-volt collector potential between pulses, it is necessary to have a time separation between subsequent pulses that is long compared to the pulse duration.

An alternative gate circuit, which can operate at higher word rates, is illustrated in the phase reversal unit. The gate circuit output for a ZERO input is a positive, differentiated pulse fed to the base of  $Q_{11}$  of the storage flip-flop, driving it into conduction. The base circuit of gate

transistor  $Q_{10}$  is the same as in the previous gate circuits and  $Q_{10}$  will therefore remain cut off with a ZERO at the register input.

The collector side of  $Q_{10}$  is connected in parallel with the second flip-flop transistor  $Q_{12}$ . If a ONE is read from the register, gate transistor  $Q_{10}$  is driven into conduction, bringing the collector voltage of  $Q_{12}$  down thus setting the flip-flop so  $Q_{11}$  is cut off and  $Q_{12}$  conducts. The differentiated pulse, which tends to set the flip-flop in the opposite direction, is swamped out because of its shorter duration.

### Storage

To obtain reliable operation of the diode switches, several milliamperes must be drawn from the storage flip-flops. Because of the 20-volt peak to peak maximum analog output signal required, the tran-

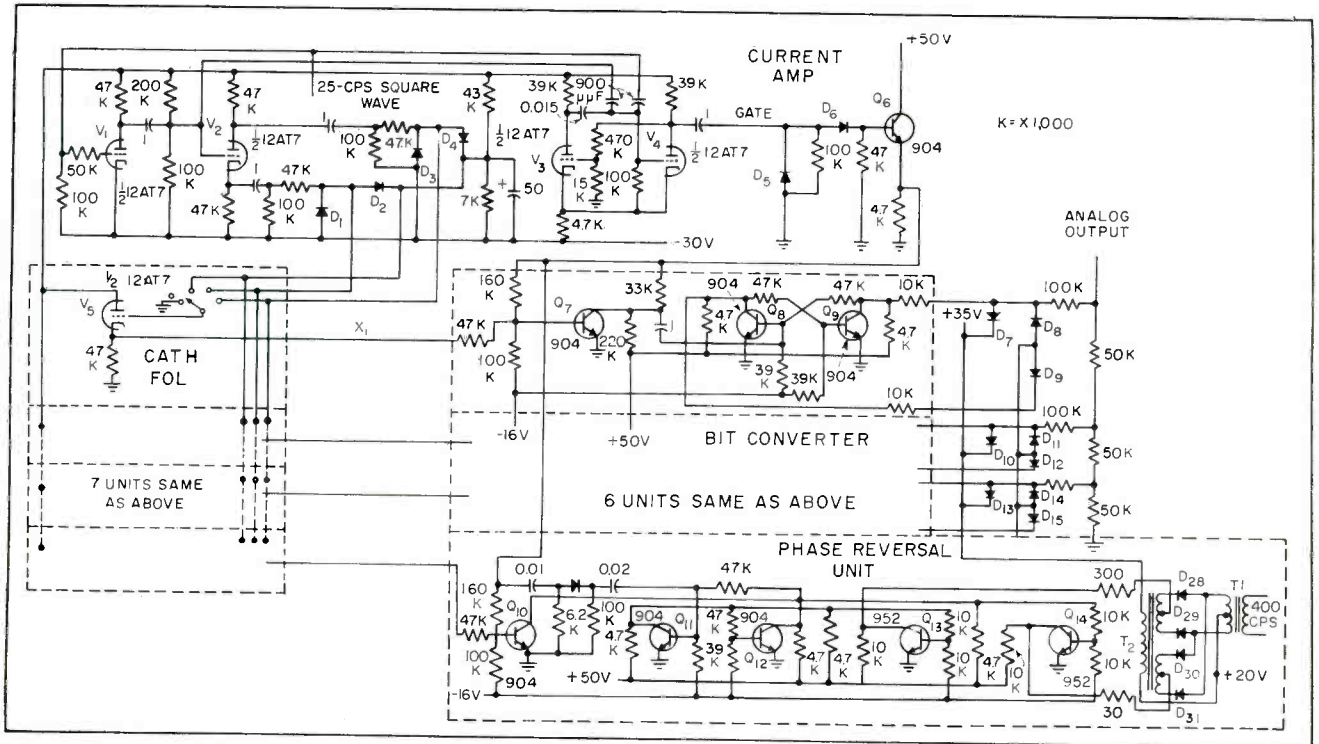

FIG. 1—Complete digital-analog converter. Electron-tube circuits check operation of transistorized converter and supply gate signal

sistors must be operated at collector voltages of up to 40 volts. The flip-flops will operate reliably using transistors with a current gain of 15. Test conditions for this gain were  $V_c = 50$  volts,  $I_c = 2$  ma and an ambient temperature of  $-55$  C.

In the simple Eccles-Jordan circuit of Fig. 1, ( $Q_8, Q_9$ ) the collector voltage swing is approximately 4 to 45 volts. To maintain the lower of these limits a low collector saturation resistance is required.

As has been mentioned previously, a ZERO read from the register will result in a positive output pulse from the gate circuit. The positive pulse from the gate circuit drives  $Q_8$  into saturation, while  $Q_9$  is cut off. Thus a ZERO from the register results in a voltage of +45 volts on the collector of  $Q_8$  and a voltage of +4 volts on the collector of  $Q_9$ . A ONE read from the register reverses the voltages.

Solution of the mesh equations

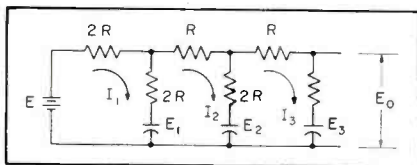

FIG. 2—Resistance matrix used to solve mesh equations to determine parameters of output circuit

for the resistance matrix of Fig. 2 provides the following equation for its output voltage:

$$\bar{E}_0 = E_3 - (E + E_1)/8 - (E_2 - E_1)/4 - (E_3 - E_2)/2$$

If  $E_0 = 0$  and  $E_1, E_2$  and  $E_3$  are assigned the values of either 0 or 1, inserting all possible combinations of these values results in the outputs shown in Table I.

Thus, if a correct resistance ratio is maintained throughout the matrix, the output will be a true analog of the digital reference voltages. A zero for  $E_1, E_2$  or  $E_3$  means a short circuit to ground, not an open circuit!

The resistance matrix described above is expanded to seven digital inputs and provided with the necessary diode switches as shown in Fig. 1. The switching diodes providing single pole-double throw action for the first binary bit are  $D_7$  and  $D_8$ . If the voltage on the collector of  $Q_8$  is +45 volts, current will flow from this point through the 10,000-ohm resistor and  $D_7$  to the +35-volt line, providing a low-impedance path between the resistance matrix tie-in resistor (100,000 ohm) and the +35-volt line, which is heavily bypassed and thus on ground potential for the 400-cps reference voltage.

The voltage at the tie point of  $D_8$

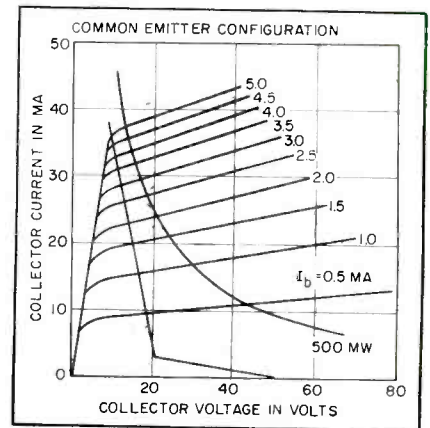

FIG. 3—Characteristic curves of transistors used as phase-reversal switches show broken load lines over which transistors are operated

and  $D_9$  is +20 volts with 20-volt peak to peak of the 400-cps voltage superimposed. Thus the highest instantaneous voltage at this point will be +30 volts and the lowest instantaneous voltage will be +10 volts. The d-c voltage at the tie point of  $D_7$  and  $D_8$  is slightly over 35 volts and  $D_8$  is therefore cutoff during the entire reference voltage swing.

If a ONE is read from the register, the voltage at the collector of  $Q_9$  is about +4 volts. Thus current is flowing from the tie point of  $D_8$  and  $D_9$ , through  $D_8$  and the 10,000-ohm



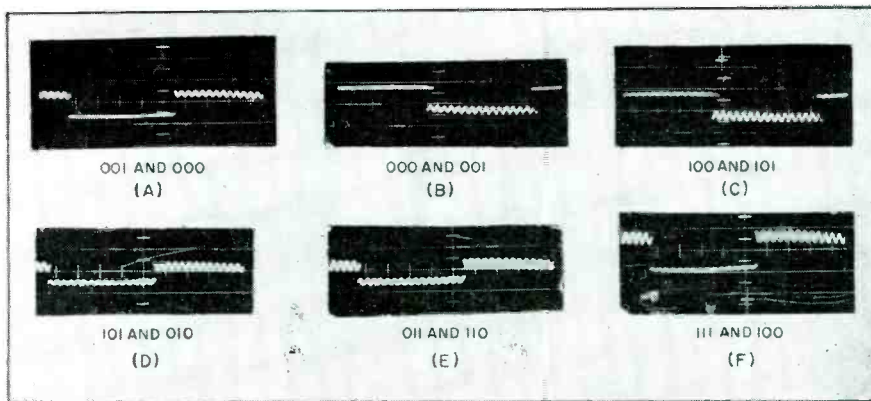

FIG. 4—Typical converter output waveshapes for the repetitious binary inputs shown

resistor to the collector of  $Q_6$ . Diode  $D_8$  will never cut off during the entire period of the reference voltage.

Since the impedance of the conducting diode  $D_8$  is small compared to the 10,000-ohm resistor, practically all of the reference voltage will appear at the tie-in point of the resistance matrix. The voltage at the tie point of  $D_7$  and  $D_8$  never goes above +30 volts. Thus  $D_7$  remains cut off during the entire reference-voltage swing.

The two load extremes on the reference source will be no-load (all converters ZERO) and a load of about 1,250 ohms (all converters ONE).

To keep reference-voltage fluctuations as a result of these varying loads to a minimum, a load compensation circuit is included in each bit converter. In the first bit converter it consists of diode  $D_6$  and the 10,000-ohm resistor connecting it to the collector of  $Q_6$ . This collector is at a low potential whenever the collector of  $Q_6$  is at a high potential and vice versa. Thus either  $D_8$  or  $D_6$  will be conducting at all times, and the variation in load of the reference signal source will be greatly reduced.

#### Phase-Reversal Unit

In the phase-reversal operation either one of the diode pairs  $D_{28}$ ,  $D_{29}$  or  $D_{30}$ ,  $D_{31}$  is biased in the conducting direction, while the other pair is cut off. The plate side of all four diodes is maintained at a d-c potential of +20 volts from the +20-volt battery through the center tap on the secondary winding of  $T_1$ . The center tap on one of the primary windings of  $T_2$  must be kept at a more positive potential to keep

the corresponding diodes cut off. The center tap on the other primary winding of  $T_2$  is at a lower d-c potential, maintaining conduction through the corresponding diodes.

Since the primary windings on  $T_2$  are connected to oppose each other, transferring the reference signal input from one of these windings to the other will shift the phase of the reference signal output voltage by 180 degrees. The d-c drawn through the forward-biased diodes must be equal to at least the required output voltage.

After quite a bit of experimentation, a diode bias current of 15 ma and a transformer  $T_2$  with an open-circuit shunt inductance of four henrys were used. The transistors driving the phase-reversal switches  $Q_{13}$  and  $Q_{14}$  are operated along a broken load line as shown in Fig. 3. As long as the collector voltage exceeds +20 volts, the transistors operate with a 10,000-ohm load resistor connected between collector and the +50 volt supply. As the collector voltage becomes less than +20 volts, the diode pair starts to conduct and the 300-ohm resistor connecting the collector to the center tap on  $T_2$  becomes the decisive part of the load. This keeps the transistor from exceeding its dissipation rating during any part of the operating cycle.

The electron-tube circuits of Fig. 1 constitute the test equipment used to check the operation of the digital to analog converter. All necessary signals are obtained from a 25-cps square wave input to provide the digital-analog converter with a repetitious series of two 8-bit binary numbers. The two numbers

can be preselected by appropriate settings of the bit selector switches in the test equipment. The test equipment also provides the gate pulse.

The outputs available from the register connections for corresponding settings of the bit selector switches are: bit selector switch in ZERO position, 0 volts; bit selector switch in ONE position, +30 volts; bit selector switch is ZERO — ONE position, 0 volts for positive half cycle of 25-cps input pulse and +30 volts for negative half cycle of input pulse; bit selector in ONE — ZERO position, +30 volts for positive half cycle of 25-cps input pulse and 0 volts for negative half cycle of input pulse. Voltages are with reference to the simulator chassis.

#### Input Signals

The input simulator must be kept at a -30 volt potential with reference to the digital-analog converter chassis. The 25-cps input pulses of negative polarity are amplified and limited in amplitude by  $V_1$ . Tube  $V_2$  is a phase splitter and the outputs available at plate and cathode are 180 degrees out of phase. Phase splitter outputs are limited to 0 volts and +35 volts by the diodes  $D_1$ ,  $D_2$  and  $D_3$ ,  $D_4$  respectively. These voltages are fed to the appropriate bit selector switch positions, in each block.

Tubes  $V_3$  and  $V_4$  constitute a monostable multivibrator with a 4-millisecond pulse time. In its stable state,  $V_4$  is conducting;  $V_3$  cut off. A positive trigger pulse at the grid of  $V_4$  will turn this tube off and consequently turn on  $V_3$ , maintaining this state until the 0.015  $\mu$ f coupling capacitor is charged. The pulse at the plate of  $V_4$  is roughly rectangular and has a 4-millisecond duration.

There must be a gate pulse for every half cycle of the 25 cps input voltage to obtain a reading of subsequent words and thus, a positive trigger pulse must be derived from positive and negative slopes of the input pulse. This is done by obtaining a differentiated pulse before and after the first amplifier stage.

Figure 4 shows the output of the digital-analog converter when driven by the input simulator.

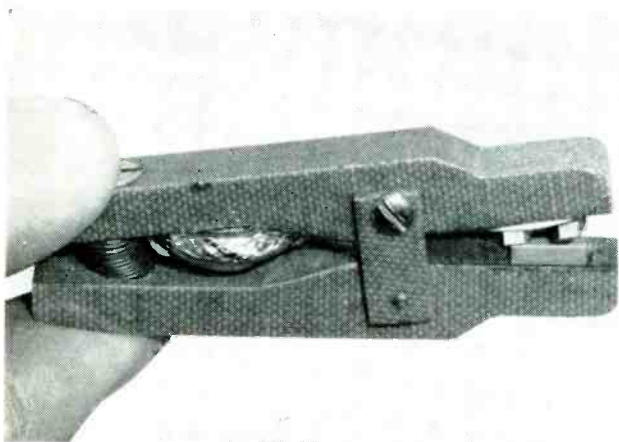

Clamp probe with toroid core shown at right



Complete microammeter with clamp

**SUMMARY** — Small toroidal current transformer clamped around unknown current measures 0 to 200-microampere range over frequency band of 50 cps to 100 kc with negligible reaction upon measured circuits. Feedback to tertiary winding supplies frequency correction to transistor amplifier

# Clamp-On Microammeter

By G. FRANKLIN MONTGOMERY and CARROLL STANSBURY

*Electronic Instrumentation Section  
National Bureau of Standards  
Washington, D. C.*

**D**IRECT-CURRENT METERS that measure minute currents without interrupting the circuit have been described in the literature.<sup>1,2</sup> The clamp-type transistor microammeter to be described was developed to demonstrate the practicality of similar a-c instruments.<sup>3</sup>

This meter uses a small current transformer which can be clamped about the unknown current. An amplifier increases the electrical out-

put of the transformer to operate an indicating meter or a cro.

## Theory of Operation

An unknown sinusoidal current of  $I$  amperes surrounded by a closed magnetic core with a secondary winding of  $N$  turns is shown in Fig. 1. The amplitude of the induced secondary voltage is

$$E = \omega N P I \quad (1)$$

where  $P$  is the core permeance in webers per ampere-turn.

If the secondary is connected to the input terminals of a zero input-impedance current amplifier as shown in Fig. 2, the input current will be

$$I_s = (I/N) / [1 + (f_c/f)^2]^{1/2} \quad (2)$$

where  $f_c = R_s / (2\pi L)$ ,  $R_s$  is the effective a-c resistance of the secondary and  $L$  is its self-inductance. The output current of the amplifier

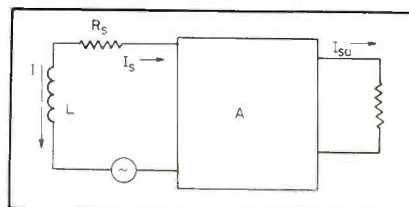

FIG. 2—Equivalent circuit of transformer probe and preamplifier

is substantially independent of  $f$  in the range where  $f \gg f_c$ . When the transformer's physical dimensions are small,  $f_c$  may be several kc.

The method of effectively reducing  $f_c$  for this instrument is to supply negative feedback from the amplifier output to a tertiary winding on the core. When this is done, the output current of the amplifier becomes  $I_{s0} = (I/N) / [1 + (f_c/Af)^2]^{1/2}$  (4) and  $f_c$  is reduced by amplifier current gain  $A$ .

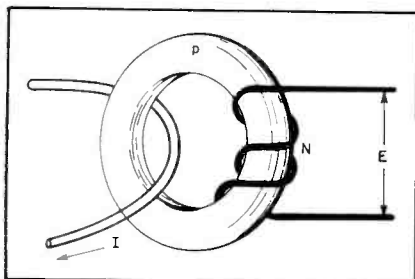

FIG. 1—Secondary winding and unknown current interlace closed magnetic core

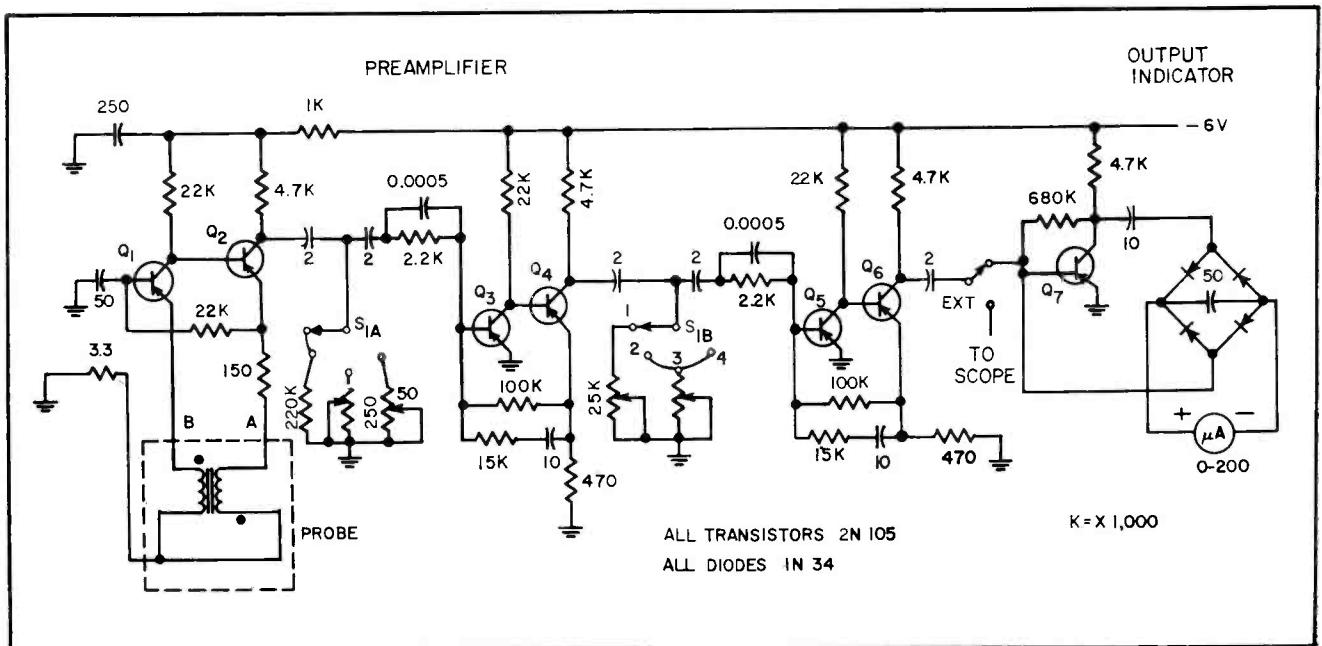

FIG. 3—Clamp-type transistor microammeter has four full-scale ranges from 200  $\mu$ a to 200 ma

# Measures A-C Current

Preamplifier  $Q_1, Q_2$  in Fig. 3 supplies frequency correction for the pickup transformer whose signal winding terminates at B. The feedback winding terminates at A.

## Output Indicator

The 200-microampere output indicator is driven by  $Q_7$  through a full-wave bridge rectifier; 100-percent negative feedback is used around  $Q_7$  to improve the rectifier linearity. The ratio of d-c output to a-c input of  $Q_7$  is therefore slightly less than unity and an input of about 220 microamperes a-c deflects the meter full scale.

If the transformer secondary winding consists of 250 turns, the output current of preamplifier  $Q_1, Q_2$  will be about 0.8 microamperes a-c for an unknown current of  $I = 200$  microamperes. Consequently, a current amplification of  $220/0.8 = 280$

is needed between the preamplifier output and the input to  $Q_7$ . Feedback pairs  $Q_3, Q_4$  and  $Q_5, Q_6$  furnish a gain of 20 per pair. Adjustable

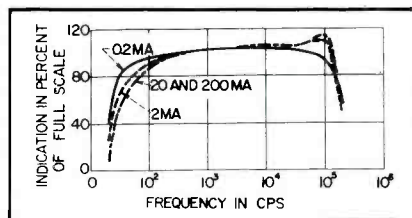

FIG. 4—Frequency response curves for four ranges of operation of transistor microammeter

shunt attenuators permit calibration of each current range.

The transformer probe consists of a silicon iron core of 0.014-in. laminations with  $\frac{1}{8}$ -in. outside dimensions and a thickness of  $\frac{1}{8}$  in. The stack of C-shaped laminations fixed in the lower jaw of the clamp

is wound with two 250-turn windings of number 44 wire. The I-sloped stack in the upper jaw is mounted on a pivot so it will seat properly on the rising legs of the C.

The response of the completed microammeter is shown in Fig. 4. The most sensitive current range, 200 microamperes full scale, is useful in the frequency range from 50 cps to 100 kc. The internally generated noise is about 20  $\mu$ s.

This work was done at NBS as part of a research program sponsored jointly by the ONR, the AFOSR, and the AEC.

## REFERENCES

- (1) E. H. Frei and D. Treves, Electronic Current Meter with Clip-on Probe, 12th National Electronics Conference, Chicago, Ill. Oct. 1, 1956.
- (2) E. H. Frei and D. Treves, Clip-On Milliammeter Uses Magnetic Amplifier, *ELECTRONICS*, p 204, Jan. 1957.
- (3) G. F. Montgomery and C. Stansbury, The Clamp-Type Alternating-Current Microammeter, AIEE Winter General Meeting, New York, Jan. 21, 1957.

**SUMMARY** — Anticipated performance is seldom achieved in passive filter circuits whose design is based solely on theoretical considerations. Distributed capacitance due to component proximity and encapsulating materials, temperature effects and impedance mismatch radically skew the results. Such pitfalls can be readily avoided, providing they are anticipated in advance and allowance made for them in the design

By **STANLEY BOYLE**

*Group Supervisor  
R-f and Electronic Test Section  
Radioplane Company  
Van Nuys, California*

# Design and Manufacture

**M**ORE AND MORE engineers are finding it necessary to design filters in their everyday circuit requirements. Design formulas for various L-C filters are available in abundant quantities in design and texts and handbooks. But as many engineers have found, the practical application of the theory is not only difficult, but to the uninitiated the construction of a suitable filter defies all attempts.

The techniques described in this article apply particularly to L-C filters using toroidal inductances although many of them can be applied to other filters of the L-C or R-C type. Whether the filter is of high-pass, low-pass, bandpass or band-rejection configuration, the design and test procedure should follow the same pattern. First the operating frequency is determined. Next, the input and output impedances are chosen to meet circuit requirements.

For correct operation, the theoretically calculated impedances and resonant frequencies must be ob-

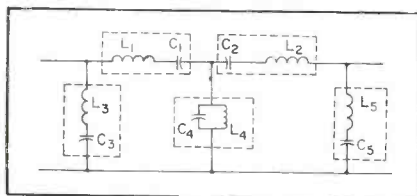

**FIG. 1**—Typical filter configuration. Circuits to be resonated separately are enclosed in dashed-line boxes

tained in the practical configuration. To accomplish this, the resonant frequencies of all circuits within the filter must be accurately attained and each L-C combination resonated as either a series or parallel circuit, as determined by its use in the filter.

The L-C combinations to be separately tuned in a simple low-pass filter are shown in Fig. 1. To tune these circuits, a signal generator, vacuum-tube voltmeter and a frequency indicator unit are required. To prevent loading of parallel resonant circuits a 100 K resistor is placed in series with the signal generator output lead. Series resonant circuits would be heavily loaded by this resistor so it is not used while tuning them. At radio or very high audio frequencies a resistor will be needed in series with the input to the vtvm.

## Filter Testing

The test circuit is shown in Fig. 2. The input voltage to the circuit should never exceed 1 v rms as toroids exhibit hysteresis and saturation effects. With voltages above 1 v rms the inductance change is great enough to cause circuit detuning. At 2 v rms most toroids will change inductance about -7 percent over the value measured at 1 v rms. Below 1 rms the inductance change is negligible for most practical filter applications. In the case of "wedding-ring" size toroids, however,

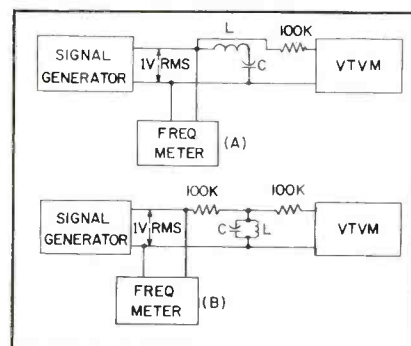

**FIG. 2**—Test setups for resonating filter sections. For series-resonant circuit (A) adjust L-C combination for null on vtvm. For parallel-tuned circuit (B) adjust for peak on meter

the signal level should be held to a maximum of 0.5 v rms.

In some cases it may be found that it is not possible to resonate the L-C combination to the desired frequency. The cause is the relatively high distributed capacitance in the toroid. Each toroid will therefore have its own parallel resonant frequency.

There are two steps to be taken in avoiding this pitfall. First, always design for the lowest impedance filter that will satisfy the circuit requirements. In any type of L-C filter the inductance is directly proportional to the filter impedance. Thus lower inductances mean higher self-resonant frequencies.

Second, after designing the filter, check with the manufacturer to

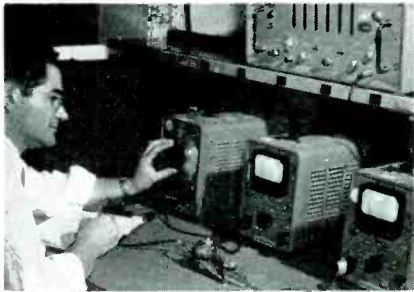

Each filter section is tuned separately

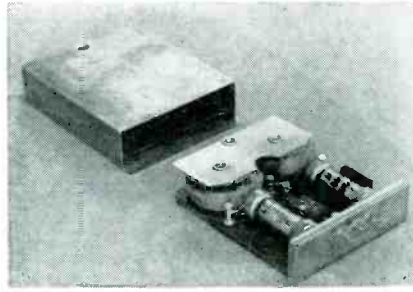

Prototype ready for hermetic sealing

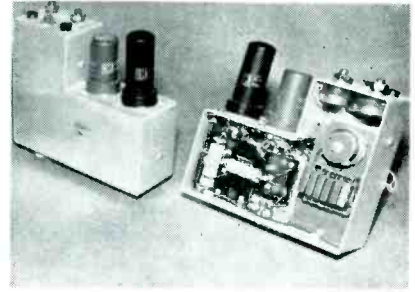

Production filter used in tone detector

# of Practical Filter Circuits

verify that the toroid self-resonant frequency is higher than that of the circuit in which it is to be used.

## Packaging

In the past it has been common practice to haywire the filter together on the bench, and after carefully laying it into a suitable container, it is encapsulated with wax, plastic or rubber compound. Invariably the encapsulated filter fails to show the same electrical characteristics which it exhibited during the bench test. The higher the operational frequency the greater the divergence between the two sets of characteristics.

The discrepancy occurs because of the dielectric effect of the encapsulating compound on the inductors and capacitors. The greatest effect occurs when the compound enters the center hole of the toroids. Wrapping the filter in fish paper before encapsulation reduces the dielectric effects somewhat but does not add to the mechanical rigidity and over-all filter reliability.

The entire filter should be assembled on a phenolic board. Capacitors are soldered between parallel bus wires. Toroids may be mounted either singly or in multiple units by means of machine screws through the holes. The toroids may be laid against each other with no measurable effect upon the electrical characteristics.

For vibration it is recommended that  $\frac{1}{2}$ -in. thick cork washers be used to separate the toroids. A round phenolic washer may be used under the head of the screw to hold the entire assembly in place. The completed filter assembly, securely mounted and wired on the board, may be installed in the container without resorting to en-

lower values of capacitance, the added capacitance caused by the container walls creates a greater detuning effect upon the filter.

## Physical Size

The most effective method of reducing filter size is to resonate the toroid to a fixed value of capacitance. Varying the capacitance involves the use of a pack of capacitors for each value required in the filter. Capacitor packs use volume quickly, so a filter should be designed around standard capacitance values.

The higher the impedance of the filter, the lower will be the capacitance values and hence the smaller the volume. Toroid sizes remain the same over extremely wide ranges of inductance.

Choose the smallest physical toroid size with sufficient  $Q$  for the requirements. Once the configuration and adjacent-frequencies attenuation are established, reduce the toroid size until another filter section is needed to attain the required attenuation. Then use the next larger size toroid.

When mounting toroids, the idea may occur of running a screw through opposite sides of the filter container, and stringing the toroids on the screw. This produces a non-operative filter when the container is metal. The effect is that of a shorted turn which reduces the  $Q$

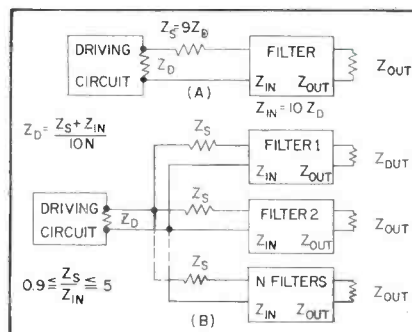

FIG. 3—Driving circuit design for single (A) and multiple (B) filter connections. The higher the ratio  $Z_s/Z_{in}$ , the better the isolation will be between filters

capsulation. Thus the response curve will remain unchanged.

At higher audio frequencies, say 10 kc and up, capacitors should not be near the container walls if they are metal. The proximity factor is even greater as the filter impedance increases since the capacitance is inversely proportional to the impedance. Since both higher frequency and higher impedance create

of the toroid to a very low value and causes considerable detuning of the circuit.

### Temperature Compensation

The average temperature coefficient of toroids is  $-180$  ppm/deg C. Temperature compensating capacitors are available in low capacitances which make high frequency filter compensation feasible. For use at audio frequencies, however, it is not possible to find large values of positive or negative coefficient capacitors.

One arrangement has worked excellently. It consists of using a combination of C or D characteristic silver mica capacitors in conjunction with metallized paper capacitors. The ratio of silver mica to metallized paper capacitance should be 5/1. This combination works exceptionally well between 0 C and  $+90$  C. Over this range, the maximum drift of filter center frequency is 0.1 percent. Between  $-20$  C and  $+90$  C the total frequency shift is 0.3 percent.

The C and D characteristic silver micas are usually between  $\pm 70$  ppm/deg. C. The metallized paper capacitors have a high positive temperature coefficient from  $+30$  C up, essentially zero coefficient from 0 C to  $+30$  C, and are highly negative from 0 C down.

### Circuit Impedance

Of primary importance to proper filter operation are both input and output impedance matching. Many a filter has exhibited different response properties in the circuit from those noted in the test setup. Generally this stems from improper input impedance circuitry. Output matching is easily accomplished by shunting the proper value of resistance across the output of the filter which usually operates into the grid circuit of the following stage.

For years it has been common practice to drive filters from cathode followers with the cathode-follower output impedance designed to match that of the filter input. But at critical band-edge or cutoff frequencies the filter impedance usually changes radically, causing the input voltage to rise and fall accordingly. This distorts the actual

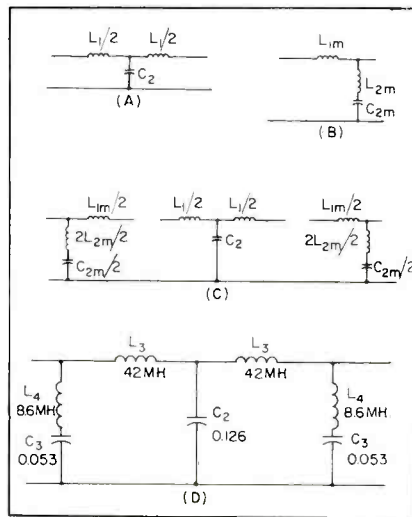

FIG. 4—Development of low-pass filter configuration, beginning with center section designed constant- $k$  (A) plus end section which is  $m$ -derived (B). Mid-section and two half-sections are combined for configuration at (D)

filter response characteristic curve.

The simplest means for alleviating this condition is to use a driving-circuit impedance not greater than one-tenth that of the filter input impedance. Matching is accomplished by using a series resistor to make up the impedance differential, in this case nine times the driving circuit value. Reduced gain is made up by one amplifier stage. The correct procedure is shown in Fig. 3. It should be noted that the higher the  $Q$  of the filter components, the more closely the measured characteristics will match the theoretical ones. Low voltage levels will aid this two ways. Overloading or saturation of the toroid will not occur and leakage in capacitors is reduced to an inconsequential level thereby raising the capacitor equivalent resistance. For this reason, 200-working-volts d-c low- $Q$  metallized paper capacitors may be used in filter circuits, even though this type of capacitor is noted for its comparatively high leakage.

### Temperature and Aging Effects

Tests have proven that toroids will change characteristics when exposed to moist air. This was especially true of the wax impregnated types, although plastic encapsulated toroids show a very pronounced improvement. Where long

period drift (time measured in years) must be kept to 0.03 percent or less, however, the best precaution is to seal the container hermetically after installation of the filter.

Bandpass filters having a center frequency of 3,100 cps and built in this manner showed not 1 cps of bandpass shift or change in width after a period of two years. In most cases it is wise to cycle the filter from room temperature to  $90$  C before hermetically sealing the unit.

### Design Examples

To best illustrate the preceding comments on filter design, two examples are given. For the first case, a low-pass filter with matching end-sections will be designed. The second example will be that of a simple bandpass filter.

For a low-pass filter, assume the following requirements:

Attenuation: 30 db down at  $2.5 F_c$ ; 0.5 db down at  $F_c$ .

Cutoff frequency:  $F_c = 3,000$  cps

Impedance:  $R = 600$  ohms

Special Requirements:  $Z_{IN}$  and  $Z_{OUT}$  should be equal (600 ohms). End sections will be  $m$ -derived since L-C attenuation will be about 18 db/octave. At  $2.5 F_c$  attenuation therefore would theoretically be 27 db. In practice it will be about 24 db.

### Cutoff Frequency

Experience has shown that attenuation at the design cutoff frequency is usually 3 db. Thus to meet the requirement of 0.5 db down at  $F_c$ , move the design  $F_c$  out to  $(1.4 \times 3,000$  cps). The 1.4 multiplier is an empirically determined factor.

The filter will be designed with a single constant- $K$  center section

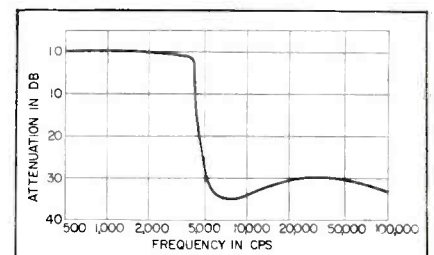

FIG. 5—Frequency response curve of low-pass filter circuit of Fig. 4D

as shown in Fig. 4A. Then

$$L_1 = R/\pi F_c = 600/(3.14 \times 4,200) = 0.046 \text{ h}$$

$$L_1/2 = 23 \text{ mh}$$

$$C_2 = 1/\pi F_c R = 1/(3.14 \times 4,200 \times 600) = 0.126 \mu\text{f}$$

### End Sections

The  $m$ -derived end sections are required when a specific frequency or frequencies require additional attenuation beyond that normally supplied by the constant- $K$  section. Additional constant- $K$  sections would supply increased attenuation beyond cutoff but would also cause excess attenuation at the cutoff frequency  $F_c$ .

In this filter, one-half an end section is placed on either side of the filter, making it symmetrical. Some volume and components could be saved by using only half an end section but the attenuation of the critical  $m$ -suppressed frequency ( $F_\infty = 2.5 F_c = 7,500 \text{ cps}$ ) would be reduced by approximately 6 db. Then

$$m = \sqrt{1 - (F_c/F_\infty)^2} = \sqrt{1 - (4,200/7,600)^2} = 0.83$$

The full  $m$ -derived end section is shown in Fig. 4B wherein

$$L_{1m} = mL_1 = 0.83 \times 0.046 = 38 \text{ mh}$$

$$L_{2m} = (1 - m)^2/4m(L_1) = 4.3 \text{ mh}$$

$$C_{2m} = mC_2 = 0.83 \times 0.126 = 0.105 \mu\text{f}$$

In dividing the  $m$ -derived end section into two parts it is necessary to halve the values of  $L_{1m}$  and  $C_{2m}$  and double the value of  $L_{2m}$ . Combining Fig. 4A and 4B with the half end sections the filter as shown in Fig. 4C is obtained.

### Practical Operation

The final filter configuration with the various components combined to give the most compact arrangement is shown in Fig. 4D. To obtain correct filter operation,  $L_3C_3$  will resonate at

$$F_c^1 = 1/(\pi \sqrt{L_3C_3}) = 2,200 \text{ cps}$$

and  $L_4C_3$  will resonate at

$$F_\infty = 1/(\pi \sqrt{L_4C_3}) = 7,500 \text{ cps.}$$

With the components resonated as indicated, the filter will exhibit an impedance of 600 ohms  $\pm 20$  percent from zero to 3,000 cps. The response will be 0.5 db down at 3,000 cps, 3 db down at 4,200 cps and 35 db down at 7,500 cps. The response curve is plotted in Fig. 5.

Care should be taken to see that the physical layout does not allow capacitive coupling between the input and output circuits. Proximity to the sides of the metal case is a common cause of input-output cou-

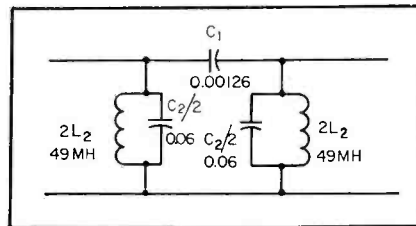

FIG. 6—A double-tuned bandpass filter in  $\pi$  form with capacitive coupling

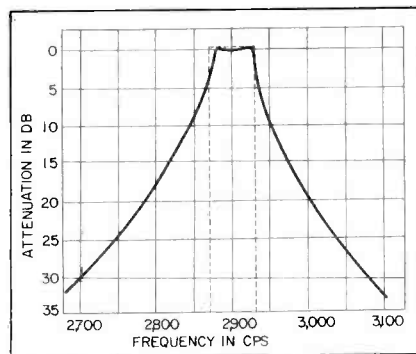

FIG. 7—Frequency response curve of bandpass filter circuit of Fig. 6. Broken line shows ideal pass band

pling, thus causing the low-pass effect to be nullified at higher frequencies. Many a low-pass filter designed for cutoff in the audio frequencies has looked like a direct wire connection at 50 or 100 kc.

If this particular low-pass filter were to be connected in parallel with other filters, it should be noted that at 7,500 cps the  $m$ -derived end sections are practically short circuits. Assume that another filter designed to pass frequencies between 7,000 and 9,000 cps were parallel across the input circuit of the low-pass filter. The output of the band-pass filter would be essentially zero for signals around 7,500 cps. For this reason, the two filters would require series input resistors and low impedance driving circuits for isolation.

For a band-pass filter, assume the following requirements:

Attenuation: 3 db down, 60 cps band pass; 28 db down, 200 cps either side of  $F_c$ .

Center frequency:  $F_c = 2.9 \text{ kc.}$

Bandwidth: 60 cps (2,870 to 2,930)

Impedance: 30,000 ohms

Special Requirements: Miniaturize if possible. Must be temperature compensated between  $-20 \text{ C}$  and  $+80 \text{ C}$ .

### Band-Pass Design

The filter configuration used as a first attempt will be a simple capacitance-coupled, double-tuned  $\pi$  circuit as shown in Fig. 6. Then

$$C_1 = (F_1 + F_2)/(4\pi F_1 F_2 R) = 0.00183 \mu\text{f}$$

wherein

$F_1$  is 2,870 cps,  $F_2$  is 2,930 cps and

$R$  is 30,000 ohms.

In addition,

$$C_2 = F_1/[\pi F_2(F_2 - F_1)R] = 0.173 \mu\text{f}$$

$$C_2/2 = 0.087 \mu\text{f}$$

$$L_2 = R(F_2 - F_1)/(4\pi F_1 F_2) = 0.017 \text{ h}$$

$$2L_2 = 34 \text{ mh}$$

Since the filter must be temperature compensated the combination of silver mica and metalized paper capacitors may be tried. As practically all the drift with temperature would be in the tuned circuits and not in  $C_1$ , only the  $C_2/2$  values will be temperature-compensated. If a 0.01- $\mu\text{f}$  metalized paper and two 0.025- $\mu\text{f}$  silver micas (total 0.06  $\mu\text{f}$ ) are used the capacitor packs are small, keeping the filter size to a minimum.

Assuming that a filter impedance higher than 30,000 ohms may be tolerated (in some cases this is very desirable), the  $C_2$  formula may be solved for  $R$  by substituting 0.06  $\mu\text{f}$  for  $C_2/2$  or 0.12  $\mu\text{f}$  for  $C_2$ .

Thus we have

$$R = 2,870/(3.14 \times 2,930 \times 60 \times 0.12 \times 10^{-6}) = 43,400 \text{ ohms}$$

Solving for  $C_1$  and  $2L_2$  using this new value of impedance:

$$C_1 = 0.00126 \mu\text{f}$$

$$2L_2 = 49 \text{ mh}$$

### Results in Manufacture

A production model of this filter shows less than 0.2 percent drift between  $-20 \text{ C}$  and  $+90 \text{ C}$ . Between  $0 \text{ C}$  and  $+90 \text{ C}$  the drift is 0.1 percent or less. The response curve of this filter is shown in Fig. 7. The 3 db bandwidth in production is 60 cps  $\pm 1$  cps, and the attenuation at  $\pm 200$  cps of center frequency is 30 db or better.

**SUMMARY** — Use of complementary transistors decreases recovery time of monostable multivibrator. This prevents erratic operation when circuit is used in a television sync generator. Since both transistors are off during timing cycle, circuit is relatively insensitive to transistor variations and operates reliably from  $-50$  to  $+70$  C for input frequencies from 250 cps to one mc

By **A. I. ARONSON** and **C. F. CHONG\***

*Commercial Electronics Products  
Radio Corporation of America  
Camden, New Jersey*

# Monovibrator Has

**G**ENERATION of accurate television line and frame frequency rates, a function common to all sync generators, is generally done by starting with a stable high-frequency crystal oscillator and counting down in proper multiples to the desired frequencies. Frequency division is often accomplished with multivibrator circuits.

## Monostable Multivibrator

In one such circuit a monostable multivibrator uses the complementary symmetry property of transistors and is shown in Fig. 1. Transistors  $Q_1$  and  $Q_2$  are biased on. With an applied negative trigger,  $Q_1$  is turned off, causing the voltage at  $A$  to go to slightly less than  $V_1$ . Since the voltage across  $C_1$  cannot change instantaneously, it appears also at point  $B$ , the base of  $Q_2$ , turn-

ing  $Q_2$  off. Capacitor  $C_1$  discharges towards  $V_2$  through  $R_2$  and  $R_5$ .

When the voltage at  $B$  goes negative,  $Q_2$  starts conducting and turns  $Q_1$  on. Capacitor  $C_1$  now discharges through a path comprising the saturation resistance of  $Q_1$  and the input resistance of  $Q_2$ . After  $C_1$  is fully discharged,  $Q_1$  and  $Q_2$  are on and ready for another input trigger to start the circuit recycling. Frequency division is accomplished by controlling the length of time  $Q_1$  and  $Q_2$  are off so that a specified number of input triggers can be accepted without causing circuit action.

## Advantages

Use of complementary transistors in place of similar conductivity transistors provides a higher charge-to-discharge ratio of the

timing capacitor. In addition both transistors are off during the timing cycle thereby reducing the effects of transistor variations on timing accuracy.

## Charge-Discharge Ratio

High charge-to-discharge ratio is desirable because unreliable operation can occur if an input trigger is coincident with the discharge of  $C_1$ .

In a conventional monostable circuit<sup>1,2</sup> the timing capacitor discharges through a collector load resistor of one transistor and the input resistance of the other while in the present circuit the capacitor discharges through the saturation resistance of one transistor and an input resistance of the other. Since

\*Now with Remington Rand Univac, Phila., Pa.

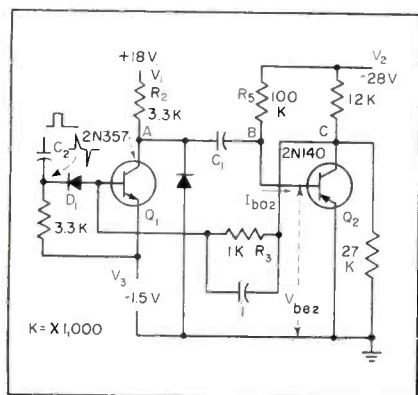

FIG. 1—Monostable multivibrator circuit uses complementary-symmetry facility of transistors to decrease recovery time

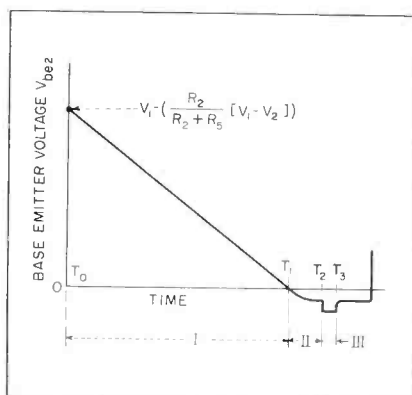

FIG. 2—Base-emitter recovery voltage of  $Q_2$  sketched for three intervals of timing cycles. Intervals II and III are expanded

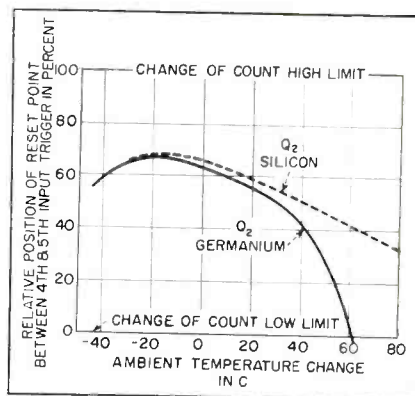

FIG. 3—Shift in reset point,  $T_2$  of Fig. 2. A shift to 0 or 100 percent indicates a miscount of 4 or 6 respectively



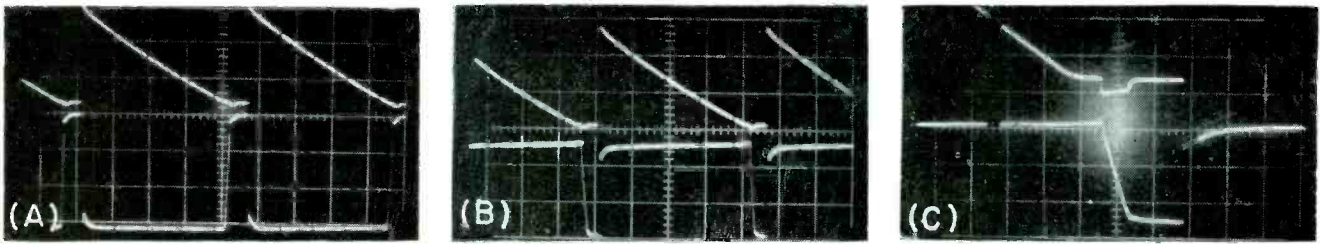

FIG. 4—Oscillograms of a 1-kc input signal for frequency-divider circuit. Waveforms (A) show base-emitter voltage  $V_{be2}$  (top) and collector voltage (bottom) of  $Q_2$  with scale  $v=5v/divider$  and  $h=1 ms/divider$ , while (B) shows base-emitter voltage,  $V_{be2}$  (top) and collector voltage (bottom) of  $Q_1$  with scale  $v=5v/divider$  and  $h=1 ms/divider$  and (C) shows waveform (B) on expanded scale

# Fast Recovery Time

the sum of the latter resistances is low, an increase of five or more in charge-to-discharge ratio can be obtained with this circuit.

Figure 2 is a diagram of the recovery voltage  $V_{be2}$  on the base of  $Q_2$  for three intervals of the timing cycle. When  $T > T_1$  and  $V_{be2}$  crosses zero,  $Q_2$  begins to conduct. Charging of  $C_1$  is controlled by the base-emitter diode of  $Q_2$ . Interval III is the discharge time of  $C_1$ . Interval II and III each represent about 2 percent of the total recovery time.

The duration from the starting trigger to the time  $V_{be2}$  equals zero corresponding to interval I in Fig. 2 is given by

$$T_1 = (R_2 + R_3) C_1$$

$$\ln \left\{ \frac{V_2 - I_{bo2} R_3 - V_1 + A}{V_2 - I_{bo2} R_3} \right\}$$

Where  $A = [R_2 / (R_2 + R_3)] (V_1 - V_2)$

Values of  $C_1$  and  $C_2$  are a function of the operating frequency and the desired time constants.

## Circuit Reliability

When both transistors are off, the timing is controlled at room temperature, primarily by passive elements. At elevated temperatures, however, the reverse saturation current  $I_{bo2}$  of the *pn*p unit approximately doubles for each 7 C of temperature rise.

The voltage drop across  $R_3$  caused by current  $I_{bo2}$  is high enough at high temperatures to influence the charge time of  $C_1$ . Reducing the effects of  $I_{bo2}$  by decreasing  $R_3$  is

undesirable because this also decreases the charge-to-discharge ratio of the circuit.

Use of a silicon transistor for  $Q_2$  gives a 100-to-1 reduction in  $I_{bo2}$  and is the best means of reducing temperature effects on circuit recovery time. Improvement in circuit reliability using a silicon transistor for  $Q_2$  is illustrated in Fig. 3. This curve shows the percentage

shift in the reset point,  $T_2$  of Fig. 2, of the circuit used as a divide-by-five counter as a function of temperature. A shift to either zero or 100 percent indicates a miscount to four or six respectively. For moderate temperature ranges a germanium transistor for  $Q_2$  will be satisfactory.

Resistor  $R_3$  helps reduce the input trigger power required to turn  $Q_1$  off by limiting the base current in  $Q_1$ . The collector diode prevents  $Q_1$  from going into saturation reducing further the trigger power required.

## Application

A sync generator can be built using this circuit which occupies 54 cu in. and weighs one pound. It requires 0.7 w of power.

The frequency divider circuit operates reliably with input trigger from 250 cps to one mc. Various waveforms for a 1-kc input signal are shown in Fig. 4A and B. The voltage at the base of  $Q_2$  is enlarged in Fig. 4C to indicate the change in the recovery-voltage waveform due to the input diode of  $Q_2$ .

The circuit operates reliably with input triggers from 0.2 to 20 v.

Credit is due Dr. H. J. Woll for the circuit proposal and for his encouragement during the development.

## REFERENCES

- (1) L. P. Hunter, "Handbook of Semiconductor Electronics", p 15-11, McGraw-Hill Book Co. Inc., New York, 1956.
- (2) J. Millman and H. Taub, "Pulse and Digital Circuits", p 174, p 599, McGraw-Hill Book Co. Inc., New York, 1957.

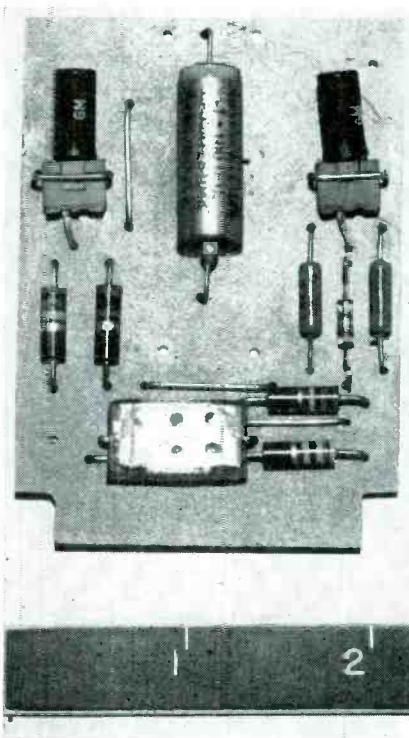

Monostable circuit constructed on a printed wiring plug-in board

# Charts Simplify Passive

By DONALD R. J. WHITE\*

Research Department  
Avion Division  
ACF Industries, Inc.  
Alexandria, Va.

**SUMMARY** — Universal design data permit design of Butterworth and Tchebycheff filters of prescribed steady-state insertion-loss characteristics. Design of band-pass prototypes of lumped-element configuration is given

Table I—Realizability of Band-Pass Filter Prototypes

Band-Pass Filter Type	$f_0 = 1 \text{ kc}$						$f_0 = 10 \text{ kc}$								
	$Q_L = 5$		$Q_L = 20$		$Q_L = 100$		$Q_L = 5$		$Q_L = 20$		$Q_L = 100$				
	50	10K	50	10K	50	10K	50	10K	50	10K	50	10K			
3A	I	P	P	I	I	I	I	I	I	M	R	P	I	M	P
3B	I	P	P	I	I	I	I	I	I	M	R	P	I	M	P
3C	I	M	I	I	I	I	I	I	M	P	M	I	P	P	I
3D	P	P	P	P	P	I	P	P	I	R	R	P	R	P	P
3E	P	P	I	P	P	I	P	P	I	R	R	P	R	P	P
3F	I	M	P	I	I	P	I	I	M	M	P	R	I	P	R
3G	M	P	I	M	P	I	M	P	I	P	R	P	P	P	P
3H	I	M	P	I	I	P	I	I	M	M	P	P	I	P	P
Band-Pass Filter Type	$f_0 = 100 \text{ kc}$						$f_0 = 1 \text{ mc}$								
	$Q_L = 5$		$Q_L = 20$		$Q_L = 100$		$Q_L = 5$		$Q_L = 20$		$Q_L = 100$				
	50	10K	50	10K	50	10K	50	10K	50	10K	50	10K			
3A	P	R	R	P	P	I	M	M	I	P	R	P	P	P	I
3B	P	R	R	P	P	I	M	M	I	P	R	P	P	P	I
3C	P	R	P	P	R	P	M	P	P	R	R	P	R	R	M
3D	R	R	P	R	R	P	R	R	P	R	R	P	R	R	M
3E	R	R	P	R	R	P	R	P	P	R	R	P	R	R	M
3F	P	R	R	P	R	R	M	P	R	P	R	R	P	R	R
3G	R	R	P	R	R	P	R	R	P	R	R	P	R	R	M
3H	P	R	R	P	R	R	M	P	R	R	R	R	P	R	R
Band-Pass Filter Type	$f_0 = 10 \text{ mc}$						$f_0 = 100 \text{ mc}$								
	$Q_L = 5$		$Q_L = 20$		$Q_L = 100$		$Q_L = 5$		$Q_L = 20$		$Q_L = 100$				
	50	10K	50	10K	50	10K	50	10K	50	10K	50	10K			
3A	M	P	M	I	P	I	I	I	I	I	I	I	I	I	I
3B	M	P	M	I	P	I	I	I	I	I	I	I	I	I	I
3C	P	R	M	R	P	I	I	M	I	I	M	I	R	I	I
3D	P	R	M	M	P	I	P	M	I	M	M	I	I	I	I
3E	R	R	M	P	P	I	P	M	I	P	M	I	M	I	I
3F	M	R	P	I	P	P	I	P	P	I	P	M	I	I	I
3G	R	R	M	R	P	I	P	M	I	P	M	I	P	I	I
3H	M	R	R	I	P	R	I	M	R	I	M	R	I	I	P

Readily realizable (R):  
 $1 \mu\text{h} \leq L \leq 100 \text{ mh}$   
 $5 \mu\mu\text{f} \leq C \leq 0.1 \mu\text{f}$

Practical (P):  
 $0.2 \mu\text{h} \leq L \leq 10 \text{ h}$   
 $1.0 \mu\mu\text{f} \leq C \leq 1.0 \mu\text{f}$

Marginally practical (M):  
 $0.05 \mu\text{h} \leq L \leq 30 \text{ h}$   
 $0.3 \mu\mu\text{f} \leq C \leq 5 \mu\text{f}$

All others: impractical (I)

$300 \text{ cps} \leq f_0 < 3 \text{ kc}; f_0 = 1 \text{ kc}$   
 $3 \text{ kc} \leq f_0 < 30 \text{ kc}; f_0 = 10 \text{ kc}$   
 $30 \text{ kc} \leq f_0 < 300 \text{ kc}; f_0 = 100 \text{ kc}$   
 $300 \text{ kc} \leq f_0 < 3 \text{ mc}; f_0 = 1 \text{ mc}$   
 $3 \text{ mc} \leq f_0 < 30 \text{ mc}; f_0 = 10 \text{ mc}$   
 $30 \text{ mc} \leq f_0 < 500 \text{ mc}; f_0 = 100 \text{ mc}$

$10 \leq R < 150; R = 50$   
 $150 \leq R < 2.5 \text{ K}; R = 500$   
 $2.5 \text{ K} \leq R < 50 \text{ K}; R = 10 \text{ K}$   
 $2 \leq Q_L < 10; Q_L = 5$   
 $10 \leq Q_L < 50; Q_L = 20$   
 $50 \leq Q_L < 500; Q_L = 100$

**S**IMPLIFIED DESIGN INFORMATION for band-pass filters having either a Butterworth or Tchebycheff response with lumped-element, lossless L-C components is presented. By following the prescribed method, filters can be designed with minimum time and motion.

### Filter Specifications

In designing band-pass filters the following information should be determined:

- (1) Center frequency  $f_0$ .
- (2) Either the pass-band width  $B$  or the loaded Q-factor  $Q_L$ .
- (3) Either the 60-db bandwidth  $B_{60}$  or skirt selectivity  $S_n$  in db per bandwidth.
- (4) Allowable pass-band ripple variation  $\epsilon$  in db.
- (5) Input-output impedance level  $R$  in ohms.
- (6) Maximum acceptable midband insertion loss in db.
- (7) Quality factor  $Q_0$  of L-C components.

Width of the pass band is measured between the 3-db cut-off frequency points. For Tchebycheff functions, these points correspond to the ripple variation. Items 3 and 4 establish the number of stages necessary for realizing the desired rejection just outside the pass band. The maximum-flat Butterworth response has no ripple in the pass band. However, the Tchebycheff or overcoupled response has an equal ripple variation in the pass band but offers additional skirt selectivity. Tchebycheff response use may result in fewer tuned stages.

\* Now with American Machine and Foundry Co.

# L-C Filter Design

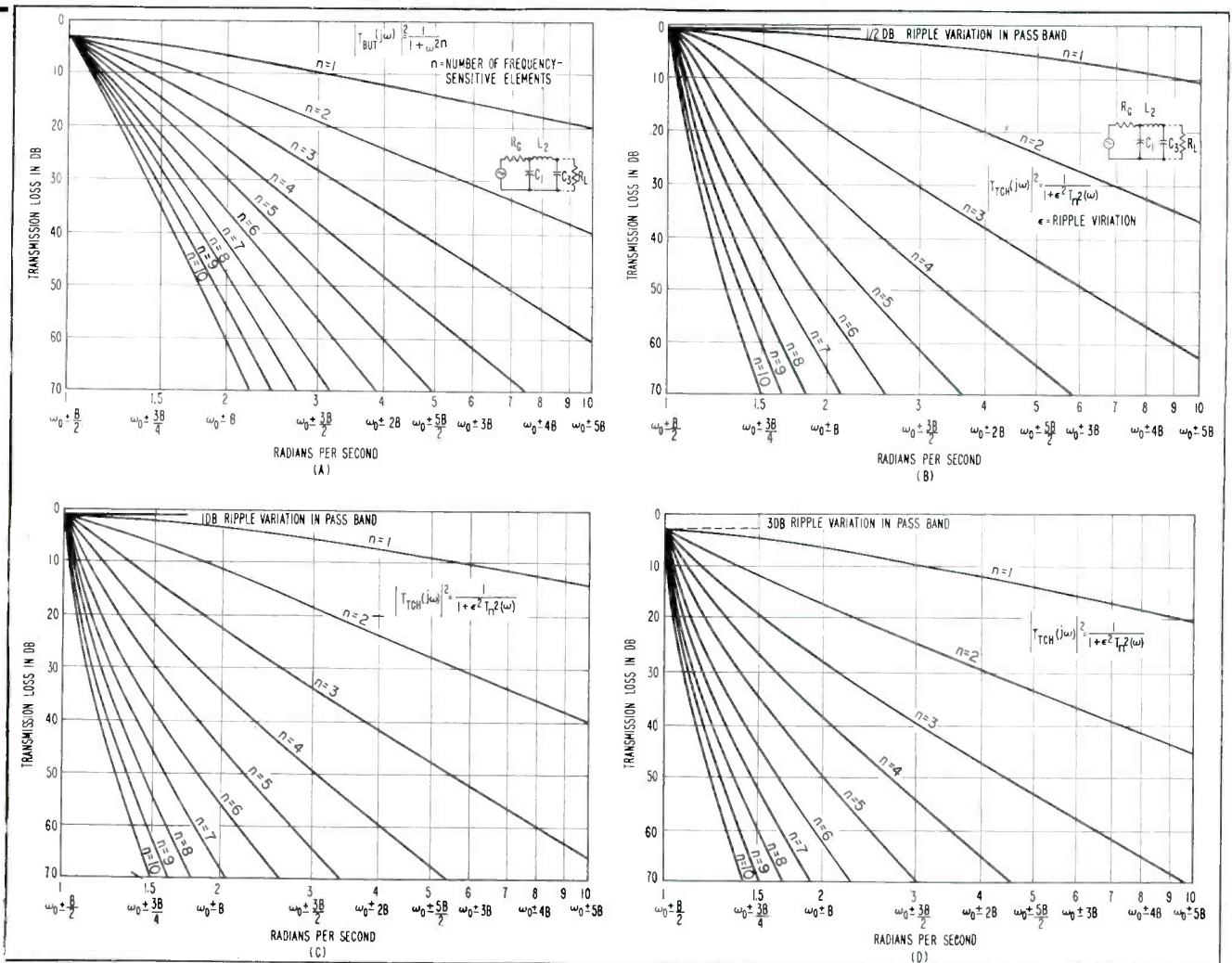

FIG. 1—Required number of filter stages can be found with the aid of transmission loss against frequency graphs for a Butterworth function (A) and for Tchebycheff functions with different ripple variations (B), (C) and (D)

Item 5 is restricted to approximately equal input and output impedances. Finally, item 7 establishes the compatibility between the physically realizable specifications 1 through 6.

## Design Procedure

When items 2, 3 and 4 are specified the required number of filter stages may readily be found by using Fig. 1A through 1D. Conversely, these graphs are useful in establishing different skirt selectivities in terms of an allowable or fixed number of stages. Although the graphs correspond to the low-pass prototype, they are equally useful for their band-pass, band-rejection or high-pass analogs.

When item 6 is selected, when  $Q_c$  of the coils and capacitors is known, and when the number of stages  $n$  is computed, the actual insertion loss may be found from the graph of Fig. 2. If the insertion loss found in Fig. 2 exceeds the maximum acceptable loss indicated by item 6, one or more specifications must be compromised.

## Filter Selection

Figures 3A through 3H are prototype band-pass filters which provide essentially the same response. The most applicable is selected. Figure 3A, 3B, and 3C have identical responses and are derived directly without approximation from the same low-pass prototype.

Since the component values may be difficult to realize, Fig. 3D through 3H offer substitute forms. The prototype most easily realized or applicable should be selected.

Table I has been prepared using each of the eight prototype band-pass filters. Frequency, loaded  $Q$  factor and impedance level are the variables. With this table the recommended filter types for each application can be readily determined.

## Components

The value of the capacitors, inductors and resistors are shown in Fig. 3A through 3H for low-pass Butterworth or Tchebycheff elements. These latter elements are

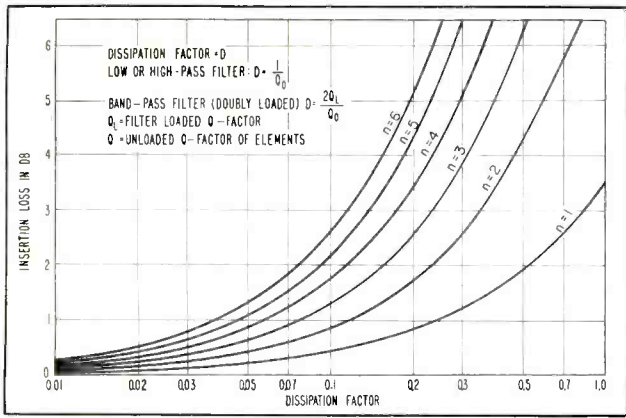
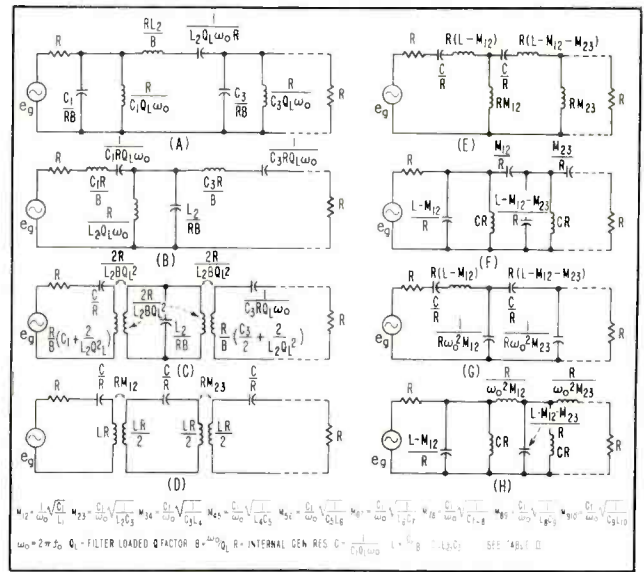

FIG. 2—Filter insertion loss may be found where dissipation factor and number of storage elements are known

FIG. 3—Since the eight illustrated prototypes have the same response, selection of the proper filter depends upon realizability and applicability of the configuration



listed in Table II for the Butterworth function and for the Tchebyscheff functions with  $\frac{1}{2}$ , 1, 2 and 3 db ripple variation.

with a center frequency of 100 kc, a 3-db bandwidth of 10 kc and therefore  $Q_L = 10$  is required. It should provide at least a 25-db rejection at  $100 \pm 15$  kc where  $db/B$

measured as shown in Fig. 4A approximates 22 db/bandwidth. Maximum allowable insertion loss should be 3 db and the filter should work into and out of a 100-ohm impedance level. The coil quality factors  $Q_0$  may be expected to be about 100 and the  $Q_0$  of the capacitors about 800. The  $Q_0$  of the capacitors thus may be neglected.

Table II—Element Values of Low-Pass Prototypes

n	Type	db Ripple	$C_1$	$L_2$	$C_3$	$L_4$	$C_5$	$L_6$	$R_9$	$R_L$
1	But	0	2						1	1
	Tch	0.5	0.699						1	1
	Tch	1	1.018						1	1
	Tch	2	1.530						1	1
	Tch	3	1.995						1	1
2	But	0	1.414	1.414					1	1
	Tch	0.5	1.403	0.707					1	1.984
	Tch	1	1.822	0.685					1	2.661
	Tch	2	2.488	0.608					1	4.120
	Tch	3	3.101	0.534					1	5.800
3	But	0	1	2	1				1	1
	Tch	0.5	1.596	1.097	1.596				1	1
	Tch	1	2.024	0.994	2.024				1	1
	Tch	2	2.711	0.833	2.711				1	1
	Tch	3	3.349	0.712	3.349				1	1
4	But	0	0.765	1.850	1.850	0.765			1	1
	Tch	0.5	1.670	1.193	2.366	0.842			1	1.984
	Tch	1	2.099	1.064	2.331	0.789			1	2.661
	Tch	2	2.793	0.881	3.606	0.682			1	4.120
	Tch	3	3.439	0.748	4.347	0.592			1	5.800
5	But	0	0.618	1.620	2	1.620	0.618		1	1
	Tch	0.5	1.706	1.230	2.541	1.230	1.706		1	1
	Tch	1	2.135	1.091	3.001	1.091	2.135		1	1
	Tch	2	2.831	0.899	3.783	0.899	2.831		1	1
	Tch	3	3.482	0.762	4.538	0.762	3.482		1	1
6	But	0	0.517	1.410	1.930	1.930	1.410	0.517	1	1
	Tch	0.5	1.725	1.218	2.606	1.314	2.476	0.870	1	1.984
	Tch	1	2.155	1.104	3.063	1.152	2.937	0.810	1	2.661
	Tch	2	2.852	0.907	3.817	0.939	3.715	0.696	1	4.120
	Tch	3	3.505	0.769	4.606	0.793	4.464	0.603	1	5.800

C in farads, L in henrys, R in ohms, n = number of frequency-sensitive elements,  $\omega$  = radians/second and  $\epsilon$  = ripple variation

Prototypes

Table I indicates that virtually all band-pass prototypes having these specifications are readily realizable.

The total number of stages required to realize the specified skirt selectivity is found in Fig. 1A to be about 2.7. Three stages will be used since only integers are possible. Figure 2 shows that the 3-stage filter would be 2.5 db based expected insertion loss for this

Using the band-pass prototype of Fig. 3A and Table II, the element values are

$$C_1' = C_3' = C_1 / (2\pi BR) = 0.16 \mu f,$$

$$L_1' = L_3' = L_2 R / 2\pi B = 16 \mu h,$$

$$C_2' = 1 / (2\pi f_0 Q_L R L_2) = 800 \mu \mu f \text{ and}$$

$$L_2' = R / (2\pi f_0 Q_L C_1) = 3.2 mh.$$

The resulting band-pass filter is shown in Fig. 5B.

Physical Realization

Since the dynamic range of the required capacitors and coils is  $L_1 C_2 Q_L^2 = 200$ , which makes physical realization inconvenient, the prototype network of Fig. 3D is

chosen. The resulting band-pass network is shown in Fig. 5A. Element values are now easily realized and are of the same order of magnitude. Frequency response of each network is shown in Fig. 5C.

As another example a 30 mc band-pass filter is required to give a maximum slope rejection per stage for which a 3 db pass-band ripple variation will be allowed. This suggests Tchebycheff response. Apart from this ripple, an additional 2-db midband insertion loss is permitted.

### Selectivity

Skirt selectivity must be at least 60 db per bandwidth and the 3-db bandwidth must be 6 mc. Therefore  $Q_L = 30/6 = 5$ . The  $Q_o$  factors of the coils used are 200. The desired impedance level is 50 ohms.

The required number of stages obtained from Fig. 1D is 5. Figure 2 shows that the minimum insertion loss resulting from these non-lossless inductors is 1.3 db. The prototype of Fig. 3F is chosen from

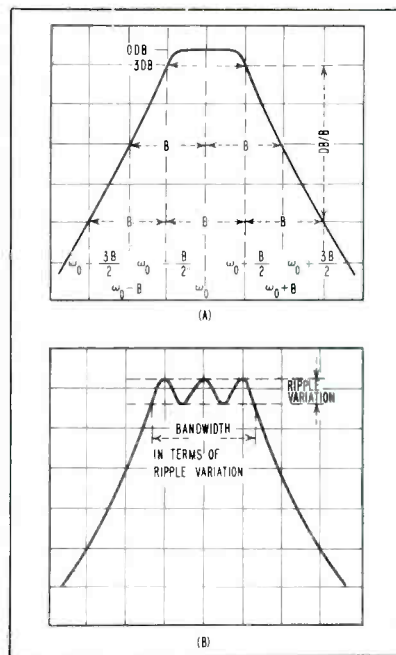

FIG. 4—Decibel/bandwidth concept of a Butterworth function is measured one bandwidth from the -3-db point of the response curve (A). Bandwidth of Tchebycheff response is measured along trough of ripple variation (B). Techniques described are usable for filter design from about 300 cps to about 500 mc using either Tchebycheff or Butterworth

Table I because of the practical realizability and the resulting filter together with its frequency response is shown in Fig. 6.

Thus, by using modern synthesis techniques a desired class of steady-state, band-pass filter responses can be obtained.

The author thanks J. H. Mills, Jr. for his work on the band-pass prototypes and table of recommended prototypes, C. L. Ranck for his work on the synthesis of the Butterworth and Tchebycheff low-pass prototypes and A. Feiner.

This work was performed under RADC contract No. AF 30(602)-1449.

### BIBLIOGRAPHY

- E. A. Guillemin, "A Summary of Modern Methods of Network Synthesis," *Advances in Electronics*, 2, p. 261, Academic Press Inc., New York, 1951.
- M. Dshal, Design of Dissipative Band-Pass Filters Producing Desired Exact Amplitude-Frequency Characteristics, *Proc IRE*, p 1050, Sept. 1949.
- G. L. Ragan, "Microwave Transmission Circuits," *MIT Rad Lab Series*, p 661, McGraw-Hill Book Co., Inc., New York, 1948.
- D. R. J. White, Synthesis of Two-Terminal-Pair Networks, and Filter Design Procedures, Interim Engineering Report for Filter Study, RADC Contract No. AF 30(602)-1449, Mar. 1 1956, May 31 1956.

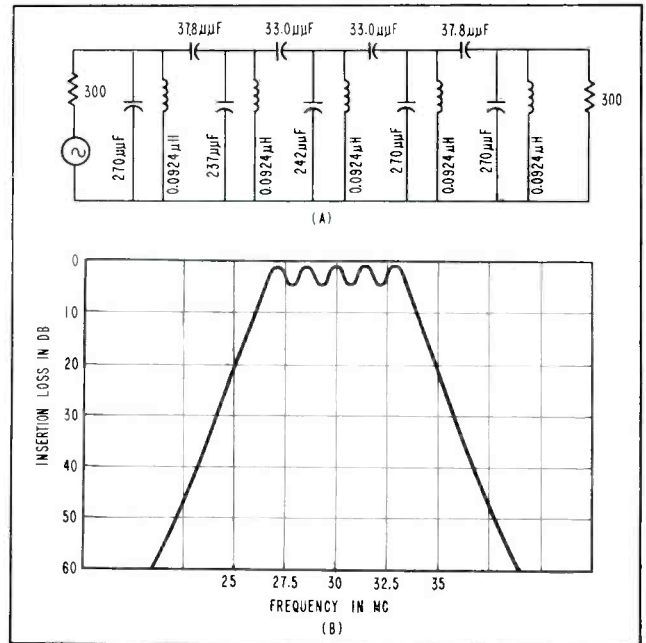
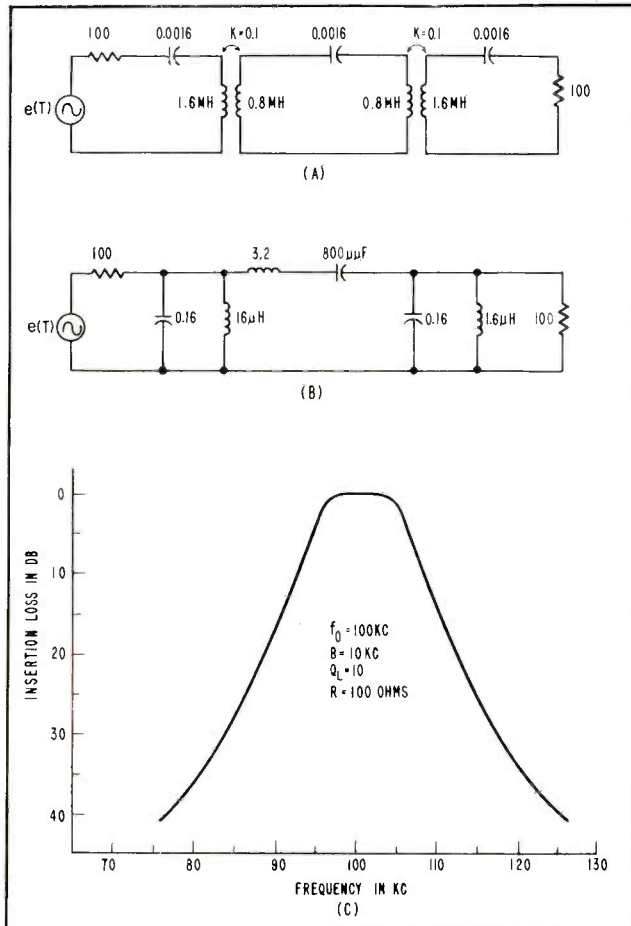
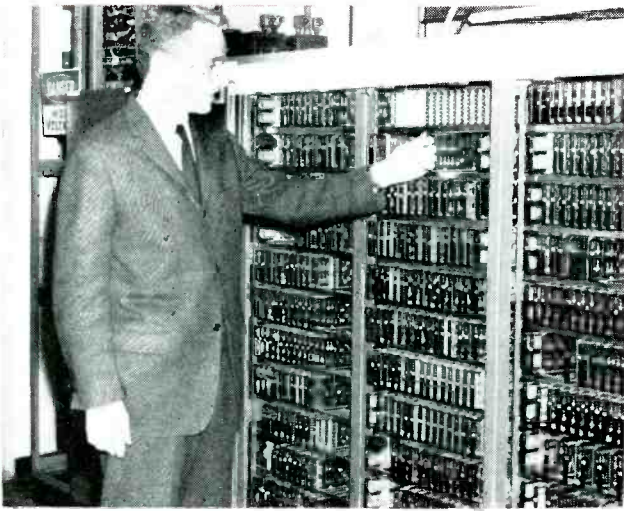
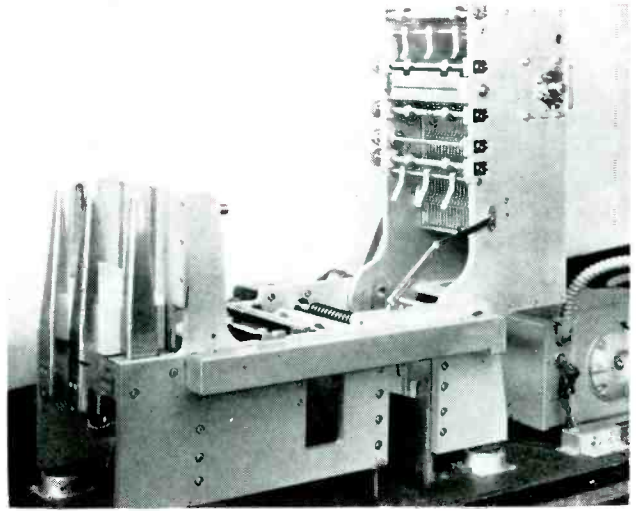

FIG. 6—Tchebycheff band-pass filter (A) was designed in second example with the aid of universal design data and has indicated frequency response (B)

FIG. 5—Although both prototypes have the same steady state frequency response (C), band-pass filter (A) is more easily realizable than filter (B)



Electronic circuits for transcribing card punch are packaged on plug-in assemblies and housed in racks shown



Cards in punch mechanism feed from left to right. Punches and solenoids are housed in hinged portion shown in open position

# Puncher Transcribes

By JAMES E. PALMER, JAMES J. O'DONNELL  
and  
CHARLES H. PROPSTER Jr.\*

*Commercial Electronic Product Division  
Radio Corporation of America  
Camden, New Jersey*

**SUMMARY** — Transistor circuits consisting of two-input resistor gates, flip-flops and other delay circuits are combined in plug-in assemblies to provide logical and driving operations for card puncher that produces business machine cards at the rate of 150 a minute. Each card is checked by reading completed card and comparing its output with original input

**L**ARGE DIGITAL DATA processing systems are often required to produce accounting machine cards punched with information in a business machine code. These cards may be used as permanent records, to communicate with other data processing facilities or as output documents in the form of bills or checks.

The transistorized transcribing card punch to be described is used with the Bizmac computing system. It converts large volumes of data stored on magnetic tape into punched accounting machine cards at the rate of 150 cards per minute and provides many accuracy con-

trol features to assure correct data punching. Transistor circuits are used throughout.

### Functional Description

The input to the transcribing card punch is received from a magnetic tape reader in seven-bit binary-coded decimal alpha-numeric code. Character rates of 10 to 30 kc are acceptable but the unit requires that the magnetic tape messages be of fixed field format. All characters appearing on tape which do not have business-machine code equivalents are interpreted as blank columns on the cards, except for certain control

symbols such as start message, end message and item separator which are deleted completely.

A plugboard permits rearrangement of data and insertion of special characters. Generally an entire message is punched into one card and the characters of the message may be rearranged in any sequence.

In all modes of operation the system checks itself by reading the cards after they have been punched and comparing them with the tape message from which they were punched. Parity check on input information provides further ac-

\* Formerly with RCA

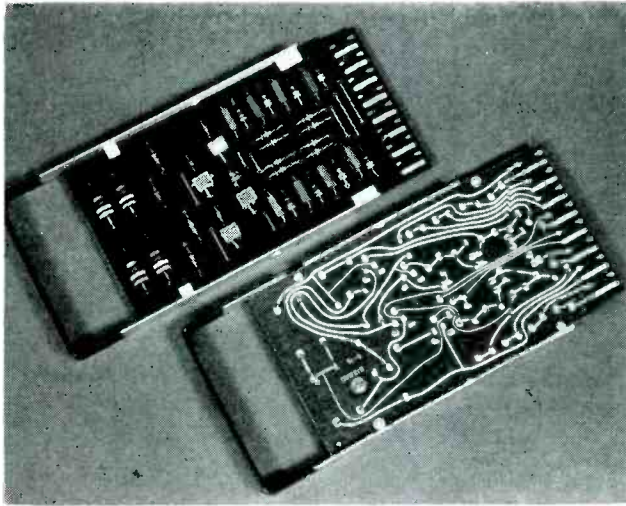

Universal gate, inverter and flip-flop plug-in assembly holds four of the basic elements shown in Fig. 3

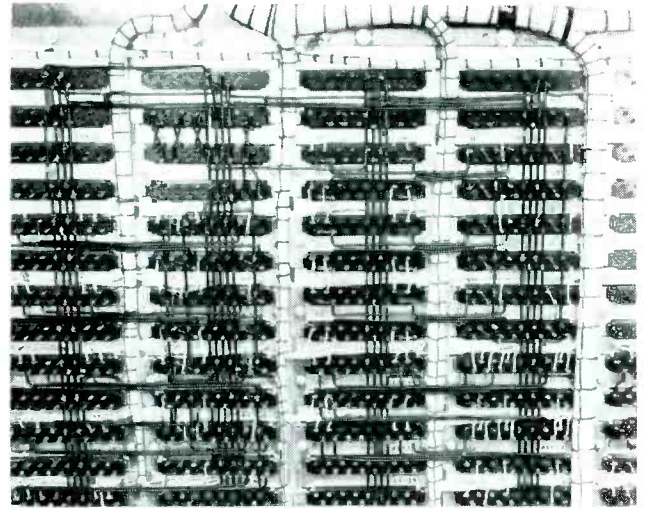

Wiring in prototype model of transcribing card punch shows simplicity and neatness resulting from use of cabled wiring

# Computer Output

curacy control. Errors stop card punching. The erroneous card is separated from the correct ones and the tape is backed up, coming to rest just ahead of the message which was punched in error.

## Logical Operation

A block diagram of the transcribing card punch is shown in Fig. 1. The temporary storage contains three sectors that are switched cyclically around the read-in, punching and checking circuits. Three messages are in process at any one time. Simultaneously one is read in, a second is punched and a third is checked. Operation will be described by following one message through a complete machine cycle.

During the read-in cycle the temporary storage is cleared and connected to the tape reader. A full card cycle of 40 millisecc is allotted for this purpose although read-in needs only part of that time. At the end of this cycle, the temporary storage sector containing the message just read in is switched to the punching circuits.

During the punch cycle, information is read from temporary

storage into the coder to convert to business machine code. The output of the coder feeds a 12-channel electronic commutator synchronized with the card advance.

The cards enter the system nine edge first and travel in a direction parallel to their shorter axes. They are moved intermittently past a punching station and punched one row at a time.

The commutator selects the output channel from the coder corresponding to the row to be punched. This card-row is sent serially to the shift register which converts the information from serial to parallel form. Eighty bits are read out simultaneously through the plugboard to a register which drives the 80 punch magnets that punch one card row. The card is advanced to the next row and the process repeated. After 11 repetitions, one card is completely punched and is then transported to the checking station located exactly one card space away from the punching station.

During the check cycle the card is read, one row at a time, by 80 brushes and the information sent through the plugboard into a second shift register. This shift register converts parallel information to serial forms. Its output is sent into a single-channel comparator.

Meanwhile, the temporary stor-

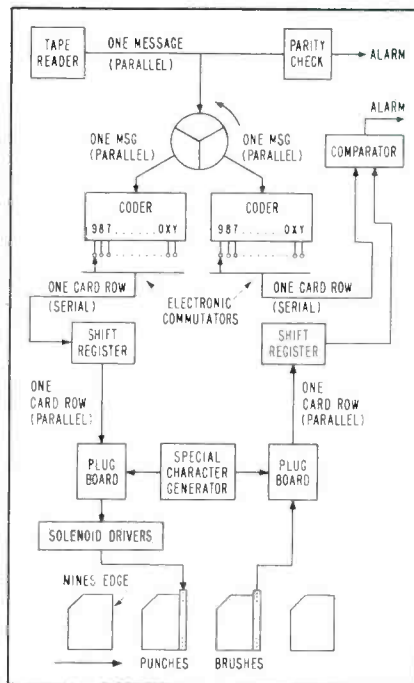

FIG. 1—Block diagram of transcribing card punch shows method whereby stored information is first used to produce punched cards and then used to check them

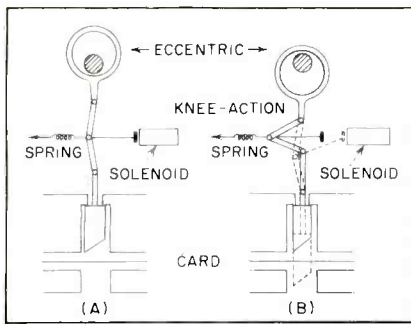

FIG. 2—Knee-action punch mechanism is shown at top of punch stroke (A). Solid lines in (B) show condition when no punching is done while dotted lines indicate condition for punching

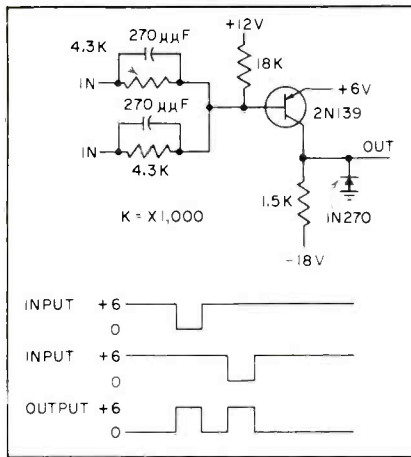

FIG. 3—Universal gate, inverter and flip-flop circuit. Response to various inputs is shown below

age sector containing the original information has been switched from the punching circuits to the checking circuits. The information in the temporary storage is translated by a second coder and another 12-channel commutator selects and routes the appropriate channel to the comparator where a check is made against the information read back from the brushes.

### Punch Mechanism

Figure 2 illustrates the knee-action punch mechanism. Eighty such mechanisms are arranged side by side permitting an entire row to be punched.

At the beginning of each punch cycle, the solenoid armature is driven into the solenoid by the mechanical motion of the knee. In this position the solenoid, if energized, moves no mechanical mass. To punch it prevents the knee from bending during the downward stroke of the eccentric. This re-

quires relatively little force at a time when the solenoid is capable of exerting its maximum force; that is, when the armature air gap is smallest.

### Transistorized Circuits

The basic circuit chosen to meet the logic requirements of the transcribing card punch is shown in simplified form in Fig. 3. This two-input resistor gate provides not only the gating function, but also signal amplification and standardization. If either input is lowered to ground potential, the transistor conducts raising the output to +6 volts. For negative going signals, defined as logical ONES, the element acts like an OR gate followed by an inverter. If a single input is used, the element functions as a simple power amplifier-inverter.

When both inputs are at +6 volts, the output will be at ground potential. Thus, the AND function preceded by inversion is obtained.

Typical delays of 0.2  $\mu$ sec per stage are obtained when these elements are cascaded. The output resistor of each element can absorb 10 ma from the stages it drives and 1.6 ma are required by each gate input. Hence, up to six gate inputs may be driven by each element.

The 18,000-ohm resistor supplies leakage currents when the transistor is not conducting. The necessary flip-flop or storage function is provided by cross-connecting two of the basic elements.

An accurate time delay or pulse-forming one-shot multivibrator is shown simplified in Fig. 4A. Application of a negative-going pulse to the input terminal triggers  $Q_1$  into conduction causing its collector to swing from ground level to +6 volts. This 6-volt swing is coupled through capacitor  $C$  which is initially charged to +6 volts. This raises the base potential of  $Q_2$  to about +12 volts and cuts off the transistor. The base potential then begins an exponential decay toward ground. When the base of  $Q_2$  reaches the vicinity of +6 volts,  $Q_2$  begins to conduct. The voltage swing required for the transition from cutoff to saturation is a few tenths of a volt and this transition is assisted by the gain of  $Q_2$  and

the feedback through  $Q_1$ . Thus, the time required to turn on  $Q_2$  is a small fraction of the total one-shot duration. Therefore, wide variation in transistor characteristics can be tolerated without compromising circuit performance. Only in the case of short duration one-shots, where transistor storage effects become important, does variation of transistor parameters become appreciable. The standard pulse width of this system is 3  $\mu$ sec. Similarly, transistor saturation voltages and diode-voltage drops have little effect as they are small compared to the 6 volts through which the time-determining capacitor must discharge.

Figure 4B shows that supply voltage variations have little effect on circuit operation. If the +6 volt

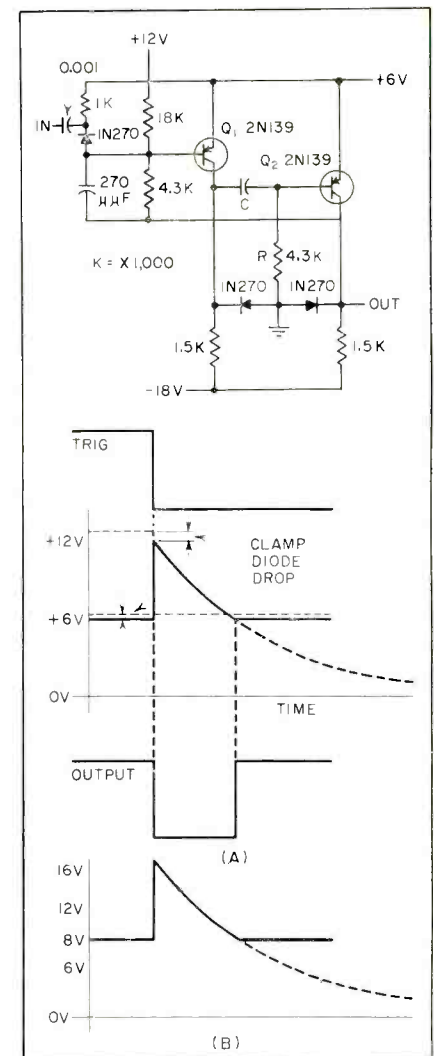

FIG. 4—Time delay or pulse-forming one-shot multivibrator (A). Waveforms show base voltage of  $Q_2$  as a function of time with correct supply voltage. Effect of increasing supply voltage is shown in (B)



supply should rise to +8V then  $C$  would be initially charged to +8V also. When  $Q_1$  turns on in response to a trigger, its collector swings through 8 volts and the base of  $Q_2$  moves to +16V. The decay takes place as before but starts from a much higher voltage. However, the base of  $Q_2$  must only drop to +8 volts before  $Q_2$  begins to conduct. This is half way between its starting point and ground just as in the case of a +6 volt supply. Hence, the duration of the output pulse remains the same.

### Shift Register

The two-cell shift-register in Fig. 5 has provision for parallel input, gated-parallel output, serial input, serial output and reset; thereby making a single circuit universally applicable to all shift register requirements.

Each flip-flop cell is set by the application of a ONE (ground level) to its parallel input terminal, and reset at once by the application of a ONE to the reset terminal. Shifting is accomplished by the application of a ZERO (+6 volts) to the advance terminal. This advance signal must endure for at least 5  $\mu$  sec and must be separated from the previous advance signal by at least 25  $\mu$  sec.

The gated-parallel output is derived from a diode gate consisting of  $D_5$  and  $D_6$  or  $D_7$  and  $D_8$  which allows a one to be presented at the output terminals of all cells which are set whenever a ONE is applied to the gate terminal. Conversely, ZEROS will be presented at the output terminals of all cells which are reset at the time of the gate signal.

Shift-register operation may be explained by assuming  $Q_1$  and  $Q_2$  are conducting and both transistor pairs contain ZEROS. The first cell, consisting of  $Q_1$ ,  $Q_2$  and associated circuitry, is set by the application of a ONE to the first parallel input terminal labeled  $P_{1-A}$ . This causes  $Q_2$  to conduct turning  $Q_1$  off. The first cell now contains a ONE and the collector of  $Q_1$  is at ground level while the collector of  $Q_2$  is at +6 volts.

The advance terminal is held at ground level externally and 6 volts appears across the series combination of  $R_3$  and  $C_3$  charging  $C_3$  to

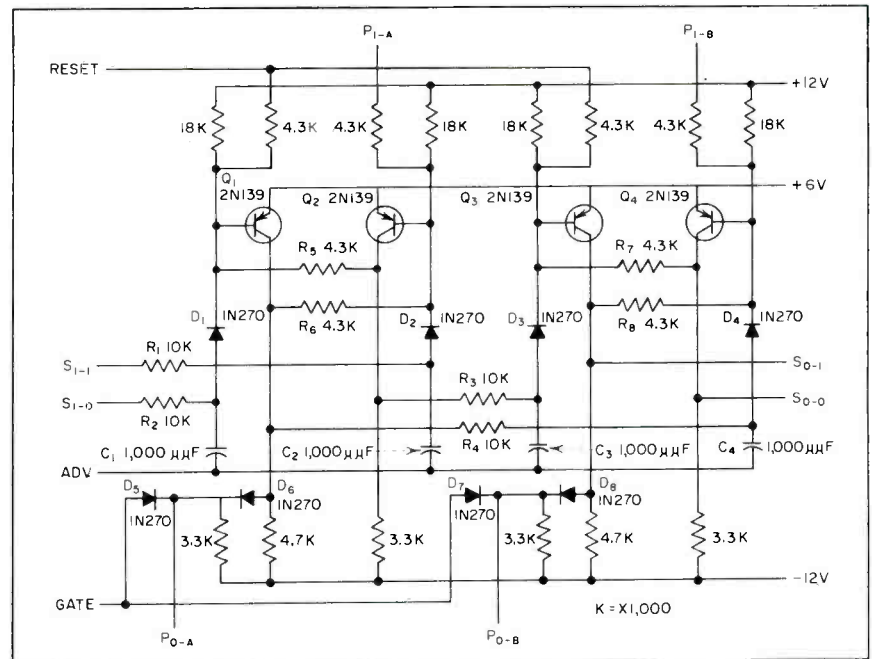

FIG. 5—Universal shift register is made up of a number of cells in cascade. Circuits are packaged four cells per plug-in unit

+6 volts. No voltage is applied across  $R_1$  and  $C_1$  as the collector of  $Q_1$  is at ground level.

After  $C_3$  has been charged the shift register is ready to receive an advance signal. When the advance terminal is raised to +6 volts, the anode of diode  $D_3$  is raised to about +12 volts by the voltage doubling effect of the charge on  $C_3$ . This biases  $D_3$  in the forward direction and allows the charge stored in  $C_3$  to flow into the base of  $Q_3$  turning it off. Flip-flop action turns on  $Q_4$  and the second cell of the shift register now contains a ONE.

The levels impressed on the serial input terminals  $S_{1-1}$  and  $S_{1-0}$  determine the charge on  $C_1$  and  $C_2$  and therefore determine the effect of the advance signal on the first

cell. If  $S_{1-0}$  is at ground level and  $S_{1-1}$  at +6 volts prior to the application of the advance signal, then the first cell is switched to the reset or ZERO state through  $D_2$ . If  $S_{1-1}$  is at ground level and  $S_{1-0}$  at +6 volts, the first cell does not change state in response to the advance signal since it already contains a ONE. The shift-register output is fed through the plugboard to a punch-solenoid driver. Four-hundred ma at 14 volts are required by the punch solenoids at a 20 percent duty cycle. As shown in Fig. 6 this power can be supplied by medium power transistors.

A flip-flop is included as part of the package to provide storage and to serve as a preamplifier for the output transistor. The flip-flop is set by a ONE and reset by a ZERO. In addition to reducing the required driving current for reset this feature allows the circuit to be used as a simple current amplifier, without storage action, by connecting the set and reset terminals together and driving them both with a one. Although the output transistor is required to supply large currents, it is still operated safely as the transistor is saturated to minimize internal dissipation.

Credit is due K. L. Chien, C. T. Cole, H. H. Cremer, N. C. Florio and R. F. Bov for their aid.

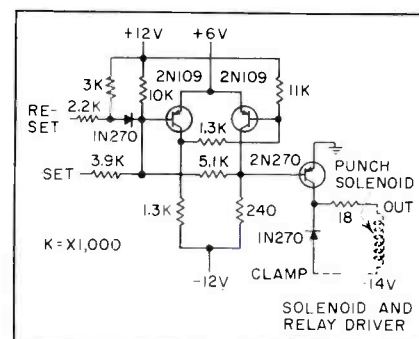

FIG. 6—Punch-solenoid driver uses medium-power transistors to supply required driving currents

**SUMMARY** — Use of solid-state rectifiers and high-current regulator tubes eliminates power transformer and reduces size and cost of power supplies. Units have regulation better than 1 percent, ripple of 0.01 percent and stacking factor of about 150-ma capacity per inch of rack space

By **W. F. SCHREIBER**

Research Department  
Technicolor Corporation  
Burbank, California

# Compact Supplies Have

**R**ACK AFTER RACK of electronic equipment, filled more than half way with power supplies is a common sight in laboratories. This condition prompted the development of regulated units that are smaller, lighter and more economical through the use of solid-state rectifiers and high current regulator tubes.

## Transformer Elimination

Elimination of the power transformer, the largest single component, requires that the d-c ground be connected to one side of the line and that voltage multipliers be used to achieve the desired output. Since laboratory a-c supplies generally have one wire grounded and a third wire connected to the conduit for safety, the power system ground may usually be used for the d-c ground. Where this is not possible or a negative output voltage is needed, the unit is merely plugged into an isolation transformer.

Chief objections to the voltage multiplier are excessive regulation and ripple. In a regulated supply this increases the required gain of the regulator.

However, the regulation is better for a low impedance a-c line than for a transformer power source. Small voltage drops across silicon or germanium rectifiers further decrease the regulation required. Finally, regulation is dependent on the capacitance as illustrated in

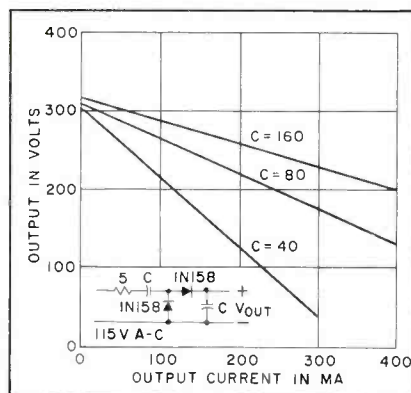

FIG. 1—Graph of dependence of voltage-doubler regulation upon capacitance

Fig. 1, and can be minimized by using the largest capacitors consistent with the peak-current rating of the rectifiers.

Elimination of the choke removes

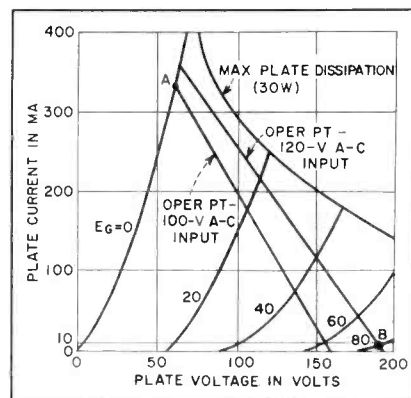

FIG. 2—Operating point loci for 100 and 120-v a-c inputs are superimposed upon plate characteristics of the Chatham 6336

the second largest expensive component and increases the regulator burden.

## The Regulator Tube

Since power supplies are generally used for fixed output voltages, high permeance triodes are preferred. At the lowest line voltage, the tube must be able to supply the required output current without positive bias. At the highest line voltage, the tube must be capable of dissipating the power due to passing full load current and the negative bias required to reduce the output current to zero should be no more than about one-half the output voltage. This permits the use of a two-stage d-c feedback amplifier without a separate power supply.

The Chatham 6336, which has a  $\mu$  of 2.7, makes the design feasible. Its high power dissipation allows the use of a single triode section in a 250-ma, 150-v power supply, thus eliminating tube paralleling difficulties.

Figure 2 shows the plate characteristics of the 6336 with the operating point loci for 100 and 120-v a-c input for a 150-v d-c supply. Point A indicates the maximum output current at the lower line voltage and point B is the required bias for zero output current. The amplifier current is 10 ma. For 250-ma output, the operating points shown skirt zero bias and maximum plate dissipation by a sufficient mar-

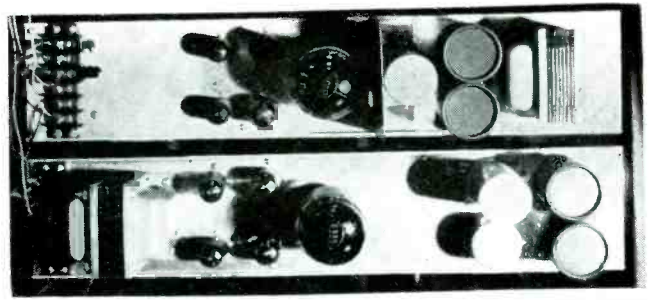
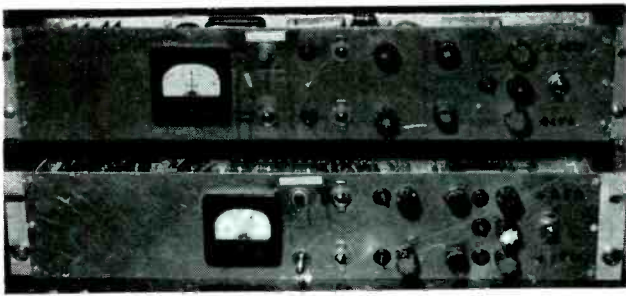

Since compact units use only one of two sections of a regulator tube, two supplies can conveniently be constructed as dual units (left). Each unit fitted on a 3 1/2-in. panel and mounted in a rack, can be either of the same type or 150 and 250-v supplies. Unit at upper right has a heat reflector between the capacitors and the 6336 to reduce heating effects caused by component proximity

# Wide-Range Regulation

gin to accommodate tube and line voltage variations. These variations make operation at 300-ma output unreliable.

## Circuit

Figure 3 is the circuit for a 150-v, 250-ma unit. The 250-v, 150-ma units which use a voltage tripler are similar. Both types have been in 40-hour per week service for over a year with good reliability. Their regulation is 1 v and the ripple is 15 mv peak-to-peak.

Since each supply uses only one of the two sections of the regulator tube, it is most economical to construct two such supplies together.

They can both be the same type or one can be 150 v and the other 250 v. No difficulty is experienced in fitting all components on a single 3 1/2-in. panel. The B- is connected to the grounded side of the line through an 8-amp fuse and to the safety ground through a 2.5-ohm resistor. The fuse will blow and a neon bulb will light if the plug is put into an incorrectly wired receptacle. The resistor ensures that current is drawn from the line and not the safety ground.

A 5-ohm resistor limits the surge current in the rectifiers to 25 amp when the unit is first turned on. Its high power rating is due to the

high rms a-c current drawn. A conventional two-stage triode amplifier is used.

Voltage adjustment made with a potentiometer across the 5651 reference tube is a superior alternative to varying the cathode resistor of the first triode as much less power is dissipated in the control.

## Reducing Heat Effects

Separation of the heat-sensitive parts, such as electrolytic capacitors as far from the regulators as possible is advisable. Heat reflectors made of shiny metal have proved effective. Free air circulation should be provided.

## Performance

For best operation or the highest output, the a-c input may be adjusted to the prevailing line voltage by connecting the secondary of the filament transformer in series (buck or boost) with the high side of the line.

The same general design has been used in a 2.5-amp supply, variable from 50 to 119 v in one-volt steps by a tap-switch control and a precision voltage divider. This supply uses eight 6394 tubes in parallel with series-strung filaments, thus eliminating the filament transformer. It is used to apply precise voltages to a 300-w lamp.

The author thanks J. M. Heyning, G. T. Inouye and C. F. Knapp for their help.

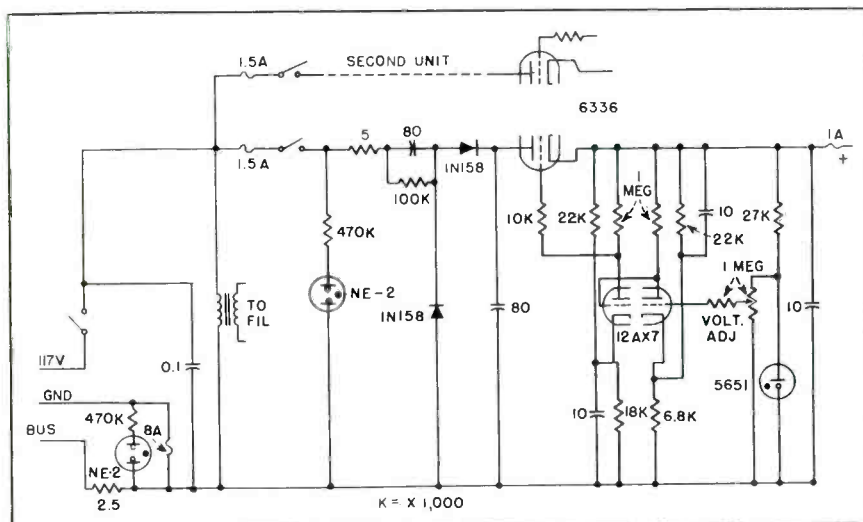

FIG. 3—Regulated 150-v, 250-ma power supply design eliminates expensive chokes and power transformers. The 5-ohm resistor limits surge current in rectifiers

# Graphic Construction

By WILLIAM VERNON HARGREAVES, JR.

Mobile Engineering Group  
Allen B. DuMont Laboratories, Inc.  
Clifton, New Jersey

**SUMMARY** — Crystal frequencies are plotted against channel frequencies to produce a direct-reading chart that reveals whether a proposed intermediate frequency in a given narrow-band f-m receiver will present spurious responses due to harmonics generated by the local oscillator. Suitable intermediate frequencies are immediately spotted for single, double and triple conversion superheterodyne receivers

**H**ERE is a quick graphical method of determining whether a proposed i-f will be suitable for use in a given receiver.

The operating frequency of the lowest i-f to be used in the receiver is chosen so that the required selectivity can be obtained. The lower this is, the greater the ease with which a strict selectivity curve or shape factor can be realized. However, too low a frequency necessitates relatively larger components in the tuned circuits and creates a selectivity burden in the preceding stages.

If the preceding stage is an r-f amplifier, it will generally be difficult to attenuate the image which will appear at a frequency two times the i-f away from the carrier. The image is always on the same side of the carrier as the injection. Thus too low an i-f yields poor image rejection while permitting excellent selectivity.

Using a high i-f improves the image rejection but makes it more difficult to achieve special selectivities or shape factors, such as those required for f-m communications where selectivity curves like that shown in Fig. 1 are desirable.

## Double Conversion

If the stage preceding the low i-f is another i-f of higher frequency, the receiver is then a double-conversion superheterodyne. This higher i-f further increases

the percentage spacing between the direct image and the carrier. The direct image is twice the high i-f away from the carrier, thus simplifying the front-end r-f selectivity circuitry.

A first i-f (the highest used in the receiver) which is too low makes it difficult to acquire good direct image rejection. The high i-f is also required to attenuate the indirect image which is twice the low i-f away from the high i-f. Thus, the lower the frequency of the high i-f the more easily the indirect image is rejected.

Conversely a high i-f which is too high permits the r-f tuned circuitry to eliminate readily the direct image, but the resultant selectivity in the high i-f is inadequate to suppress the indirect image unless a great number of tuned circuits is used in the high i-f. See Fig. 2.

Receivers having severe selectivity requirement are usually of the double-conversion type and used chiefly for bands up to 174 mc. To have sufficient image rejection when higher frequency bands are used, the 2nd i-f ends up at a

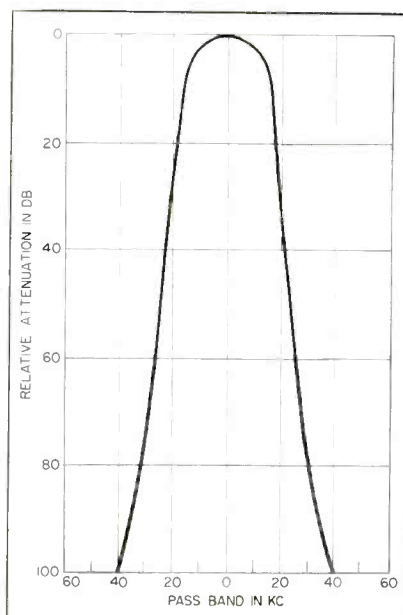

FIG. 1—Selectivity curve desirable for f-m communication

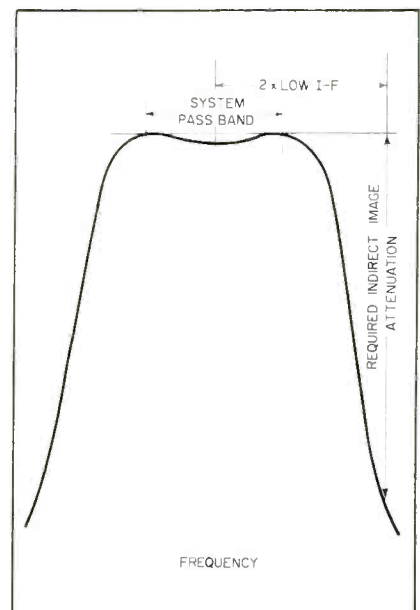

FIG. 2—Selectivity curve of high i-f is inadequate to suppress indirect image

# Finds Clear I-F

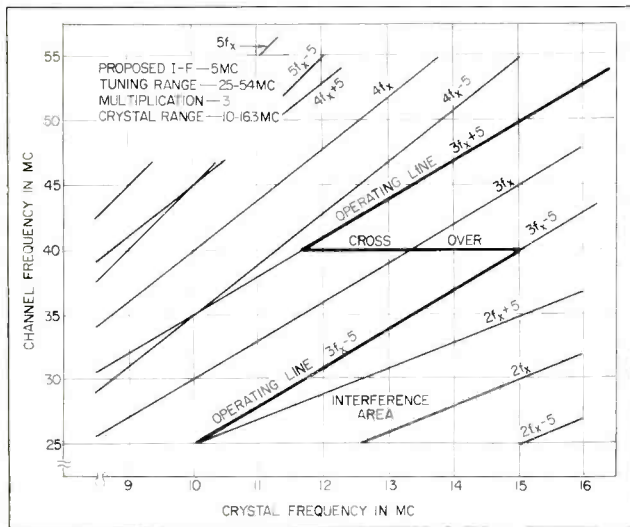

FIG. 3—Crystal frequencies are plotted against operating frequencies. The lines represent operating frequencies that are integers of 2, 3, 4 and 5 times the crystal frequency. For this example, a high i-f of 5 mc is proposed and the  $Nf_c$  plus-and-minus 5 lines are drawn parallel to the  $Nf_c$  lines. Here spurious responses are spotted at about 25 mc

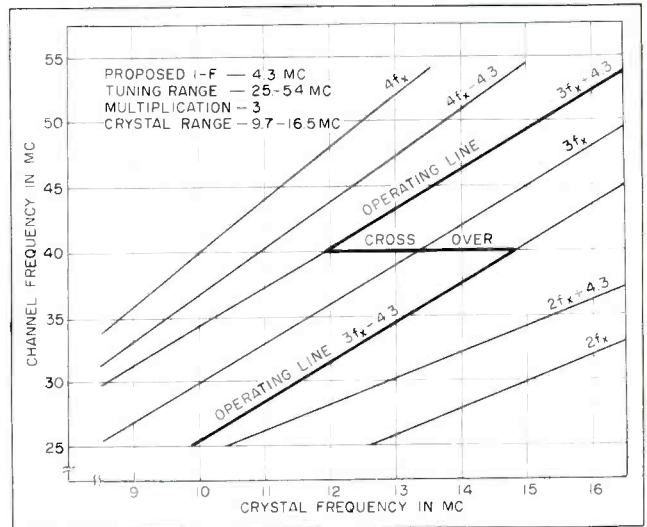

FIG. 4—In this graph, a proposed i-f of 4.3 mc is plotted, identical to the procedure used in Fig. 3. None of the  $Nf_c$  lines intersect within this range and a choice of 4.3 mc results in a receiver that is free of spurious responses. The ideal situation is to choose a high i-f that will result in a graph on which there are no intersecting lines in the operating range

rather high value. This makes adequate adjacent channel selectivity difficult.

The easiest solution is to add a 3rd i-f (of a lower frequency) to gain the necessary selectivity.

A chart of commonly-used intermediate frequencies is shown in Table I. A starting i-f is chosen from this table. The choice of an i-f then dictates the fixed frequency or frequencies of the conversion oscillators. If the first conversion oscillator is of the fundamental type which enables channel frequency trimming, then frequency multipliers are sometimes incorporated to produce the required injection frequency. The use of overtone crystals will sometimes eliminate the need for the multipliers, but overtone crystals do not lend themselves readily to trimming techniques.

The presence of these oscillator frequencies and their harmonics can mix with frequencies other than the desired signal and produce a signal at the first i-f. Such a condition results in spurious response which the graphical method spots. Rationalized or normalized ordinates are avoided for the sake

of simplicity and a direct-reading scale results.

### Construction

The graphical layout is drawn on linear-by-linear paper.

1. Choose the i-f frequencies from Table I.
2. On the vertical axis, lay off the frequency range to be tuned.
3. On the horizontal axis lay off the actual crystal frequency range of the first local oscillator.
4. By observation determine integers that, when multiplied by the values of actual crystal frequencies on the horizontal axis, yield numbers which fall within the limits of the vertical axis. For each integer draw a line which represents  $N$  times the frequency of the crystal.
5. Add two parallel lines to each of the  $Nf_c$  lines, displaced above and below the  $Nf_c$  line by a vertical axis frequency equal to the first i-f.

6. One of the lines drawn in step 5 will be the operating line. If the injection frequency is always on one side of the carrier, the operating line will be continuous. If the injection frequency is both above and below the signal frequency to minimize crystal spread,

a crossover line is drawn parallel to the horizontal axis at the crossover frequency on the vertical axis. This crossover line connects the two operating lines, one above the integer line, the other below it. Darken the operating lines for clarification.

Suppose a crystal-controlled receiver is required that will tune from 25 to 54 mc. All spurious responses and images must be 100 db down from a sensitivity of 0.3  $\mu$ v. The bandpass is to be  $\pm 15$  kc wide at the 6-db points and  $\pm 40$  kc wide at the 100-db points. Fundamental crystals are used with a multiplication of 3. Injection will be on the low side above 40 mc and on the high side below.

The graph in Fig. 3 for this example is drawn following the steps given in the preceding section.

1. Selectivity dictates the use of a low i-f between 260 and 1,600 kc. A good compromise is 455 kc. The high i-f must permit 100-db attenuation at twice its value away from the carrier. A 5.0-mc value is a good first choice, allowing the front-end circuitry to attenuate signals 10 mc off channel by 100 db.

(Continued on page 172)

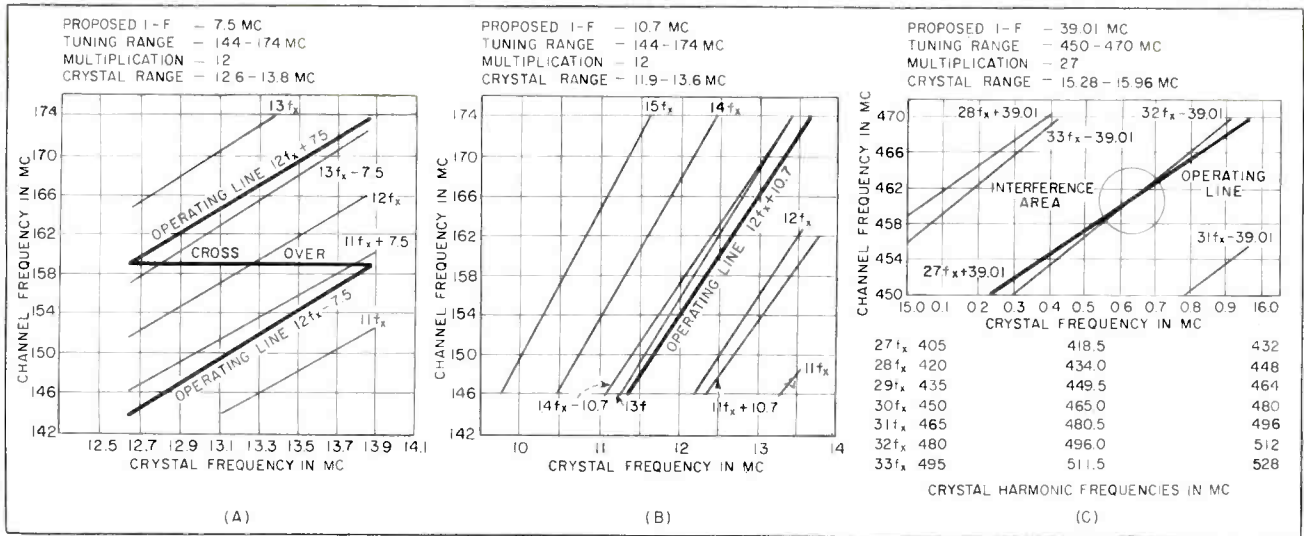

FIG. 5—Graphic plots showing various frequency ranges and i-f choices. Note that plots (B) and (C) do not make use of the crossover techniques

2. Operating frequencies of 25 to 54 mc are laid off along the vertical axis.

3. Crystal frequencies of 10 to 16.3 mc are laid off along the horizontal axis.

4. Integers of 2, 3 and 4, when multiplied by values laid off on the X axis, fall in between values laid off on the Y axis. Draw lines  $2f_x$ ,  $3f_x$ , and  $4f_x$ .

5. Another line 5 mc above the  $2f_x$  line is drawn parallel to it. A line 5 mc below can be neglected since it will fall out of range. Similarly lines 5 mc above and below are drawn parallel to the  $3f_x$  line. Draw lines  $4f_x + 5$  and  $4f_x - 5$ .

6. On the 40 mc horizontal line, darken the portion connecting the  $3f_x + 5$  and the  $3f_x - 5$  lines. This is the crossover. Darken the upper portion of the  $3f_x + 5$  and lower portion of  $3f_x - 5$  lines. These are the operating lines.

The graph now indicates an intersection of the  $2f_x + 5$  line and the operating line occurring at approximately 25 mc. For example suppose the desired channel fre-

quency was 26.11 mc. The crystal frequency yielding 26.11 mc would be  $\frac{1}{3}(26.11 + 5)$  or 10.37 mc. The second harmonic of 10.37 mc is 20.74 mc. Two signals can mix with the 20.74-mc frequency and produce a 5.0 mc i-f. They are 25.74 mc and 15.74 mc.

#### Front-End Attenuation

A 15.74-mc signal is easily attenuated in the front-end tuned circuits, but a 25.74-mc signal is only 370 kc away from the desired 26.11 mc signal. The front-end circuitry cannot be expected to attenuate such close signals, and this choice of i-f therefore results in a spurious response for each channel operating in this interference range. If the selectivity of the front end plus the selectivity of the oscillator multiplier circuits is around 2 mc for 100 db, spurious responses will be obtained when operating on channels between 25 mc and 28.5 mc.

The ideal situation is to end up with a graph on which there are no lines intersecting the operating range. From Fig. 4 it is apparent

that if the  $3f_x - 5$  line is moved closer to the  $3f_x$  line by 0.5 mc at 25 mc, the  $2f_x + 5$  line would automatically move 0.5 mc closer to the  $2f_x$  line, thus separating the  $3f_x - 5$  line from the  $2f_x + 5$  line by about 1 mc at the point where they formerly intersected.

This means changing the high i-f from 5.0 to 4.5 mc. In doing so the crystal frequencies will also change slightly, making exact values difficult to judge.

Upon obtaining a clear i-f it is wise to log all the harmonics of the second (and third, if used) conversion oscillator frequencies that occur within the operating range of the receiver.

#### Clear Frequencies

A second choice of 4.3 mc is next investigated. The identical procedure is followed in Fig. 4. Here the 4.3-mc graph is free of spurious responses due to harmonics, a good choice for the receiver. In Fig. 5A, 5B and 5C examples of various frequency ranges and i-f choices are given. Their eighth to twentieth harmonics may fall within the pass band of the receiver on certain channels.

#### Frequency Check

The remedy is to replace the second or third oscillator with a crystal that injects on the other side of the i-f. The harmonics of these alternate crystals should be computed to be sure that any alternate crystal harmonics do not fall on the same channel.

Table I—Commonly Used Frequencies in Kc

Conversion	1st I-f in Kc	2nd I-f in Mc	3rd I-f in Mc
Single	50, 262, 290, 455, 1,500, 1,600, 2,200		
Double	262, 290, 455, 456, 1,500, 2,200		2.2, 3.2, 4.3, 4.5, 6, 10.7, 21.5
Triple	290, 455	4.3, 5, 6, 10.7	15, 39.01, 41.25

# Servo Analysis Charts

By **ERWIN BISER** and **SAMUEL ADLER**

*Mathematician*

*Engineer-in-Charge*

*Servo System Engineering Activity  
Signal Corps Engineering Laboratories  
Fort Monmouth, New Jersey*

**SUMMARY** — Graphical conversion charts provide data for plotting open or closed-loop response curves of servo systems. When both amplitude and phase angle are known for either open or closed-loop operation, corresponding parameters for the opposite condition are given

**D**ESIGNING SERVO SYSTEMS usually involves compounding the elements and computing the open-loop performance. Ascertaining system performance in its applied form requires conversion of the open-loop performance to the closed-loop patterns or the inverse. The servo conversion charts enable a designer to convert amplitude and phase information for a specific frequency from one form to the other with little effort and practically no calculation.

## **Transfer Function**

This conversion can also be of value in determining the proper compensation devices for particular servo systems. The transformation formulas from which the conversion charts were made are limited to systems with unity feedback.

It is frequently impossible to obtain the open-loop performance directly from a test on the system. The open-loop transfer function is represented by the ratio of the output angle  $\theta_o$  to the error angle  $\theta_e$ . But since  $\theta_e$  is such a small quantity in sensitive servo systems, it is difficult to extract the true signal from

noise, quadrature and harmonics. The designer therefore utilizes the closed-loop transfer function  $\theta_o/\theta_e = KG/(1 + KG)$ .

## **Open to Closed Loop**

To utilize the servo conversion charts the amplitude and phase angle for a specific frequency must be known. For example an open-loop control system with a transfer function  $KG(j\omega) = 5/[j\omega(0.6j\omega + 1)(0.1j\omega + 1)]$  will have as an output when the frequency  $\omega$  is 2 radians per sec, an amplitude  $A$  of 1.6 and a phase angle  $a$  of  $-151$  deg. To determine the closed-loop response reference is made to Fig. 1A, wherein the abscissa represents the open-loop amplitude  $A$  while the ordinate represents the closed-loop amplitude  $B$ .

## **Method**

First locate the curve representing a phase angle  $a$  of  $-150$  deg, the nearest value on the chart to the  $-151$  deg given. The line  $A = 1.6$  intersects this phase-angle curve on the vertical scale at the value  $B = 1.88$ , which is the amplitude of the loop when closed.

To obtain the phase angle of the closed loop performance the chart of Fig. 1C is used. The line  $A = 1.6$  intersects the open-loop phase angle curve  $a = -150$  deg. The corresponding value of the phase angle of the closed loop  $b$  is then read on the vertical scale as  $-35$  deg.

## **Closed to Open Loop**

The servo conversion charts are equally effective in converting the closed-loop to the open-loop performance. A closed-loop transfer function of  $KG/1 + KG = 5/[j\omega(0.6j\omega + 1)(0.1j\omega + 1) + 5]$  will result in an output when the frequency  $\omega$  is 3 radians per sec, of an amplitude  $B$  of 2.62 and a phase angle  $b$  of  $-134$  deg. To transform to the open-loop characteristics for these particular values reference is made to the chart of Fig. 2A.

The line  $B = 2.62$  intersects the closed-loop phase-angle curves  $-130$  and  $-140$  deg. By interpolation the corresponding value of the open-loop amplitude  $A$  for  $b = -134$  deg is read on the vertical scale as 0.77.

To obtain the phase angle of the open loop the chart of Fig.

(Continued on page 174)

# Servo Analysis Charts (continued from page 173)

2D is used.

On the abscissa the closed-loop amplitude  $B = 2.62$  is located. This line intersects the closed-loop phase angle curves. Again by interpolation for  $b = -134$  deg the corresponding open-

loop phase angle  $a$  is read on the vertical scale as  $-168$  deg.

### Summarizing

To summarize, the charts of Fig. 1A and 1B are used to obtain the closed-loop amplitude  $B$

when the open-loop amplitude  $A$  and phase angle  $a$  are known. The charts of Fig. 1C and 1D are used to obtain the closed-loop phase angle  $b$  when  $A$  and  $a$  are known.

(Continued on page 176)

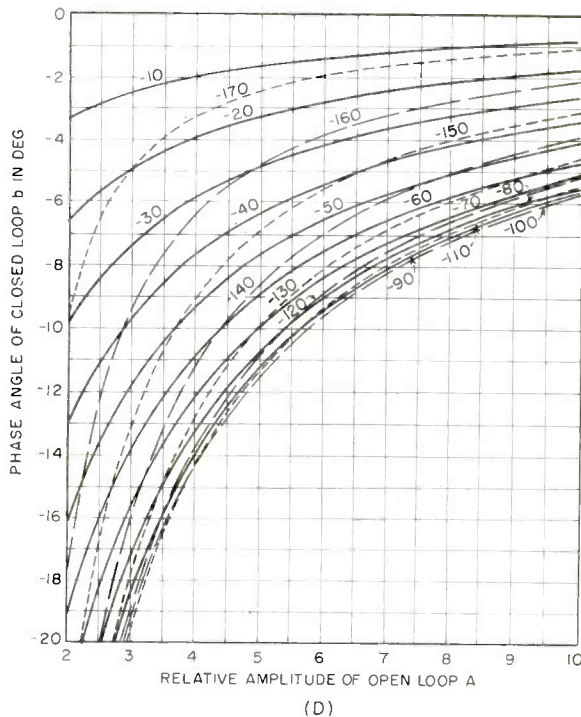
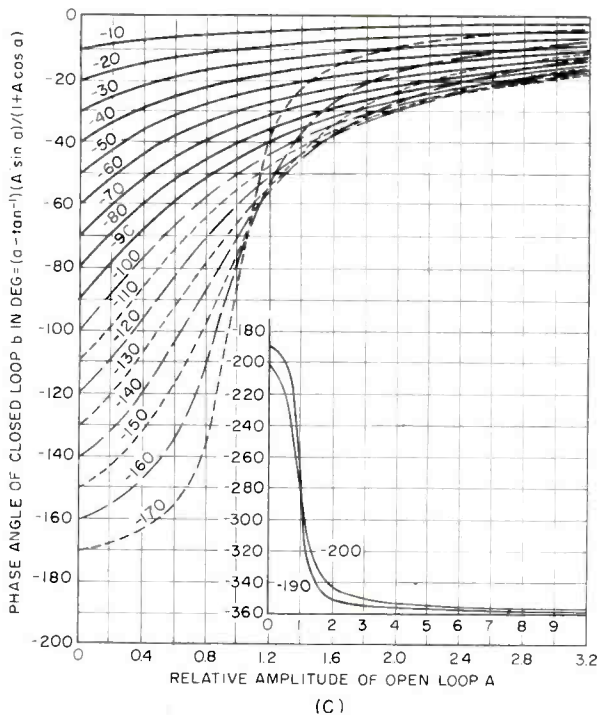
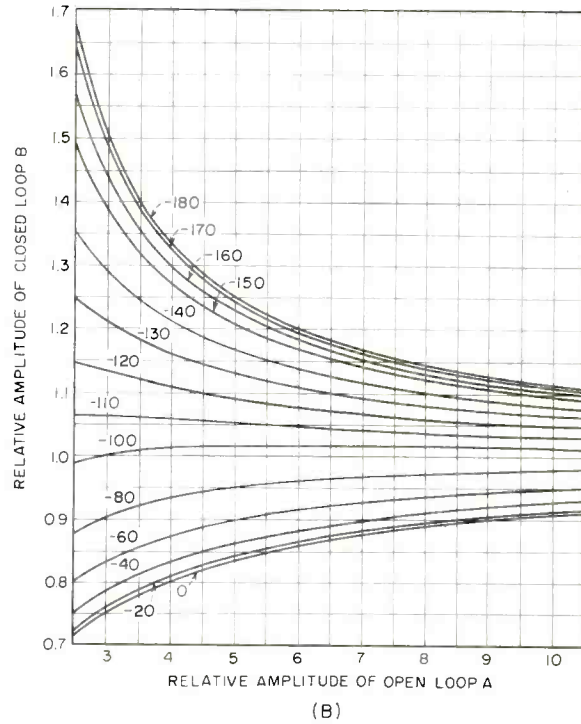
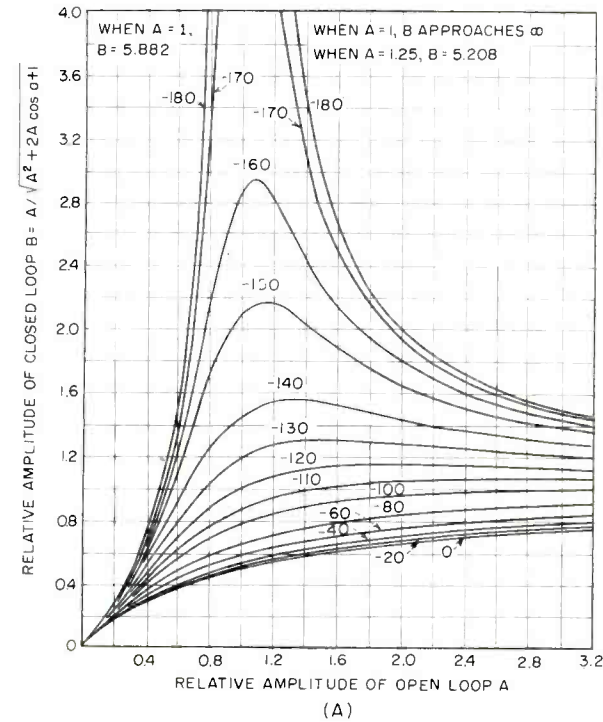

FIG. 1—Charts for conversion from open-loop to closed-loop conditions. Values on curves are expressed in degrees



# NEW CINCH



STAND-OFF Type Universal Transistor Socket.  
Shown four times actual size

# UNIVERSAL TRANSISTOR SOCKETS

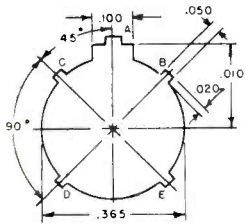

CHASSIS LAYOUT

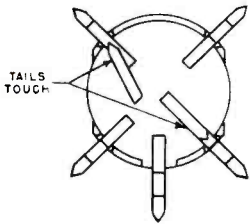

SCALE TWICE ACTUAL SIZE

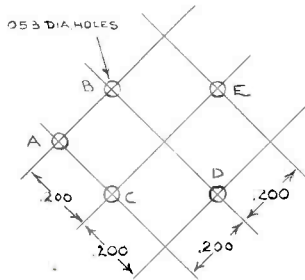

CHASSIS DRILL PATTERN

New Universal Transistor Sockets for use with the ten transistor bases illustrated and the five base types shown. Casting is mica-filled phenolic (MFE).

Contacts are beryllium copper, gold plated. Contacts may be used with either one or two sided 1/16" p. w. boards. Table at lower left lists the chassis cutout tabs required for the various base types.



STAND-OFF TYPE UNIVERSAL TRANSISTOR SOCKET



"CINCH components for printed circuitry", 24 page catalog, available on request.

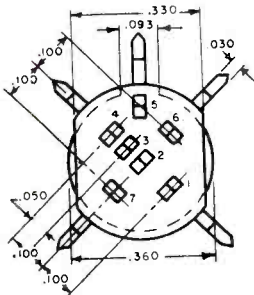

CHASSIS CUTOUT TABS REQUIRED FOR THE VARIOUS BASE TYPES

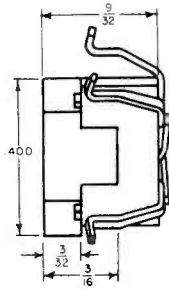

No. 24419

## TRANSISTOR BASES FOR THE NEW UNIVERSAL TRANSISTOR SOCKETS

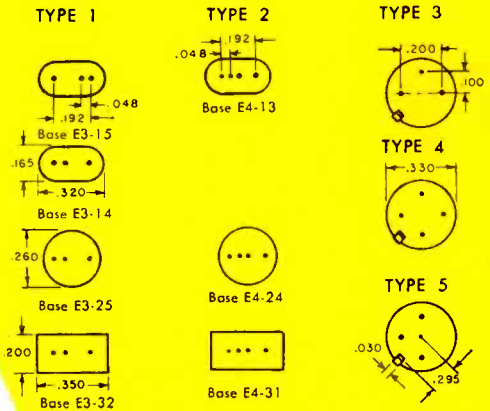

Part No.	Transistor Base Types	Chassis Cutout Tabs Used	Contact Positions Used
46T24443	All	A, B, C, D, E	All
46T24444	1 & 3	C, D, E	1, 3, 4, 7
46T24445	2 & 3	B, C, D, E	1, 2, 3, 4, 7
46T24446	3	C, D, E	1, 4, 7
46T24447	4	A, B, C, D, E	1, 4, 5, 6, 7
46T24448	5	B, D, E	1, 6, 7
46T24419	1 & 3	C, D, E	1, 3, 4, 7

In positions where contacts are not required, cavity for contact is also omitted except in position 5, on sockets 46T24444, 24445, 24446, and 24448.

CINCH will design, or re-design, components to fit specific needs, and will assist in the assembly of components through proven automation technique.



**Cinch**  
ELECTRONIC  
COMPONENTS

Centrally located plants at Chicago, Illinois; Shelbyville, Indiana; La Puente, California; St. Louis, Missouri

## CINCH MANUFACTURING CORPORATION

1026 South Homan Ave., Chicago 24, Illinois  
Subsidiary of United-Carr Fastener Corporation, Cambridge, Mass.

# Servo Analysis Charts (continued from page 174)

The charts of Fig. 2A and 2B are used to obtain the open-loop amplitude  $A$  when the closed-loop amplitude  $B$  and phase angle  $b$  are known. The charts of Fig. 2C and 2D are used to obtain the open-loop phase angle  $a$  when  $B$  and  $b$  are known.

To plot a representative closed-loop or open-loop response curve usually requires eight or ten frequency checks. This results in calculations involving many terms some of which may be in error. Use of these servo charts should not only eliminate the pos-

sibility of these errors, but also provide a quick means of improving system performance.

### BIBLIOGRAPHY

H. M. James, N. B. Nichols and R. S. Phillips, "Theory of Servomechanisms", 25, MIT Rad Lab Series, McGraw-Hill Book Co., Inc., New York, 1947.

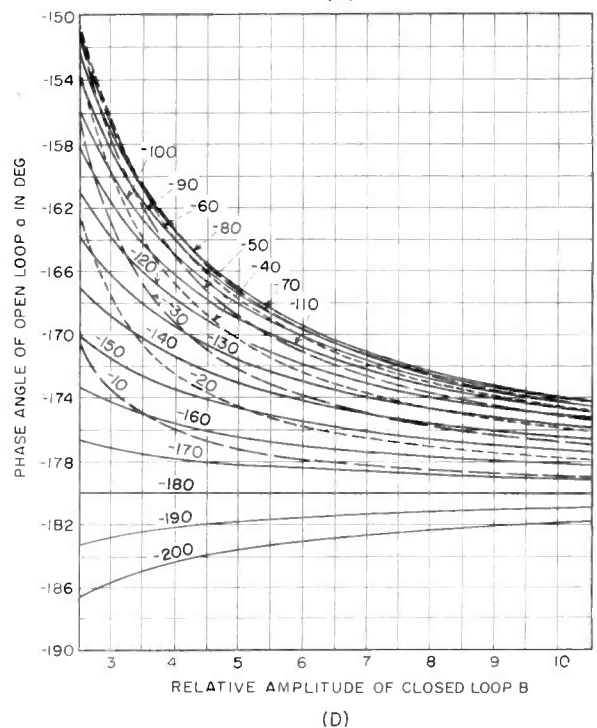
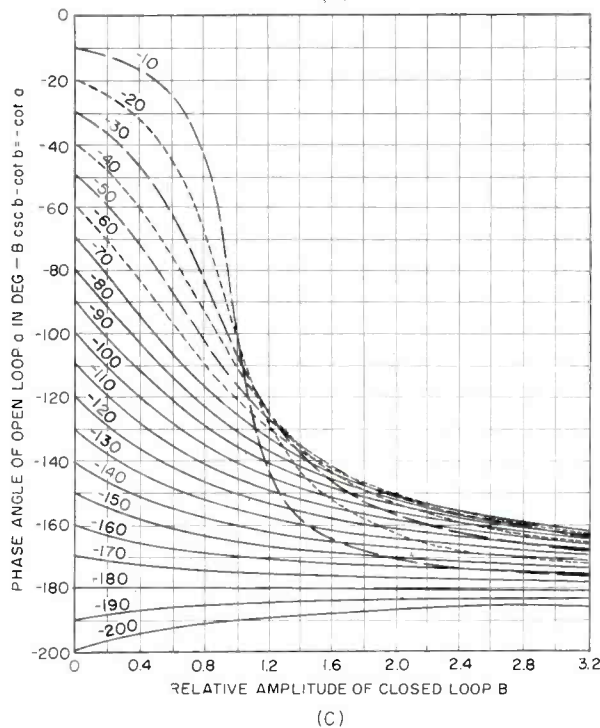
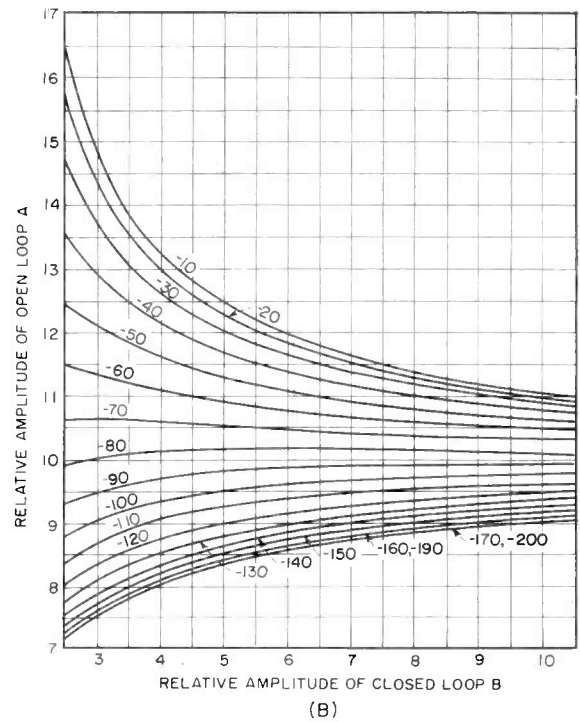
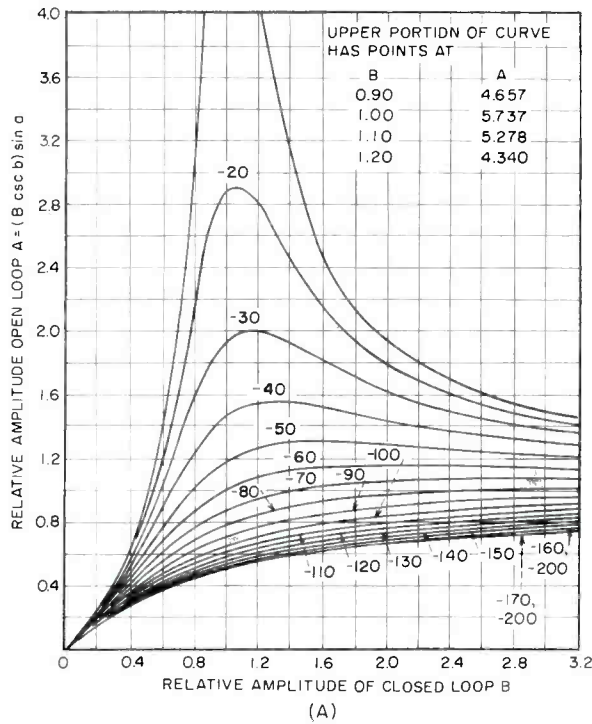
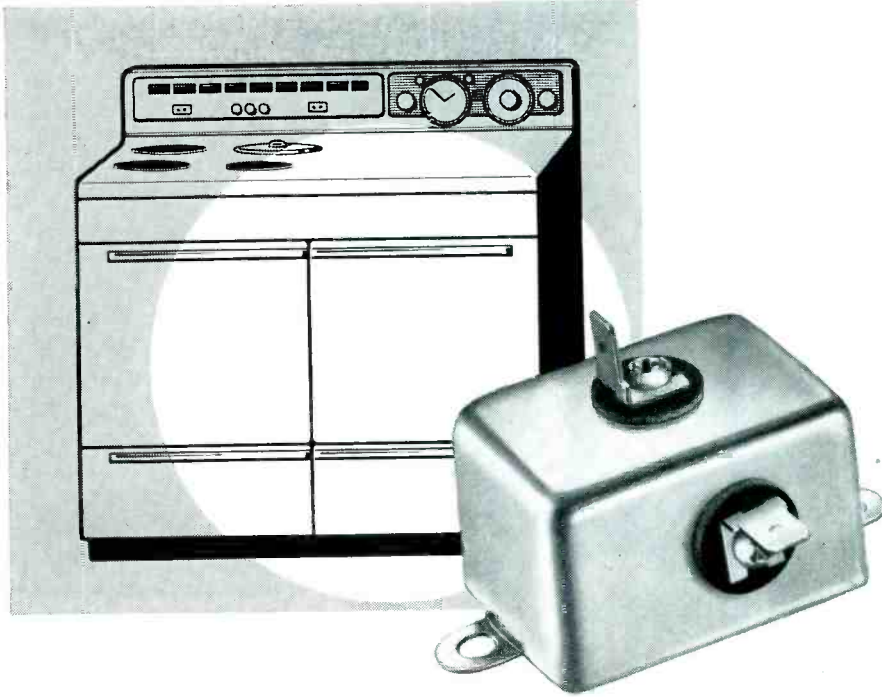

FIG. 2—Charts for conversion from closed-loop to open-loop conditions. Values on curves are expressed in degrees

Meet the buzzin' cousin of a

# Mallory *Vibrator*



A major appliance manufacturer recently had need for an economical buzzer-type alarm to act as a high-temperature signal on an oven.

The manufacturer turned to Mallory—pioneer in the automobile vibrator industry—for aid in designing this electromechanical device. The idea sounded challenging . . . so, we put our quarter-century of vibrator experience to work.

Literally overnight, we came up with a simple, practical design which we're now economically producing . . . and we have a new and satisfied customer.

Maybe you, too, have need for components that might be considered "buzzin' cousins" to a vibrator . . . not only in the home appliance field, but perhaps for industrial products. If so, there's a wealth of experience and engineering ability in Mallory's Vibrator Division that can help solve problems you may have in electromagnetic or electromechanical devices. Let's talk it over!

**Serving Industry with These Products:**

**Electromechanical** — Resistors • Switches • Tuning Devices • Vibrators  
**Electrochemical** — Capacitors • Mercury and Zinc-Carbon Batteries  
**Metallurgical** — Contacts • Special Metals • Welding Materials

*Parts distributors in all major cities stock Mallory standard components for your convenience.*

**Expect more...get more from**

**P. R. MALLORY & CO. Inc.**  
**MALLORY**

**P. R. MALLORY & CO. Inc., INDIANAPOLIS 6, INDIANA**

## Conductor Size and Spacing for Printed Circuits

BY L. N. MERSON  
Philadelphia, Pa.

CONDUCTOR SIZE is determined by the desired current-carrying capacity of the wire. For circular copper wire, the general practice is to allow 300 to 400 circular mils per ampere for normal ventilation and space conditions, and 500 to 600 mils per amp for small poorly ventilated enclosures. The following formulas were developed for calculating the width of strap conductors as used in printed circuits, so as to obtain the same cross-sectional area.

For normal conditions: width in inches = amps/thickness  $\times$  (235 to 315)  $\times 10^{-6}$  or

For close quarters: width in inches = amps/thickness  $\times$  (390 to 470)  $\times 10^{-6}$  or, in terms of foil weight in ounces per square foot (1 oz = 0.00135 inches thick): amps/oz  $\times$  (11/64 to 15/64) for normal conditions or amps/oz  $\times$  (19/64 to 22/64) for close quarters.

Table 1 shows the nominal widths per ampere for 1 and 2-oz copper foil.

A  $\frac{1}{8}$  in. wide strap of 2-oz copper foil is approximately equivalent to No. 24 copper wire.

Strap conductors have considerably more surface area than the equivalent circular wire. A  $\frac{3}{8}$  in. strap of 2-oz copper foil (1 amp capacity) has about 4 times the surface area of the equivalent size of circular wire, and therefore 4 times the r-f current capacity due to skin effect. This larger area

Table I—Nominal Width of Printed Circuit Conductors

	1-oz copper	2-oz copper
Normal Conditions	3/16 in./amp	3/32 in./amp
Close Quarters	5/16 in./amp	5/32 in./amp

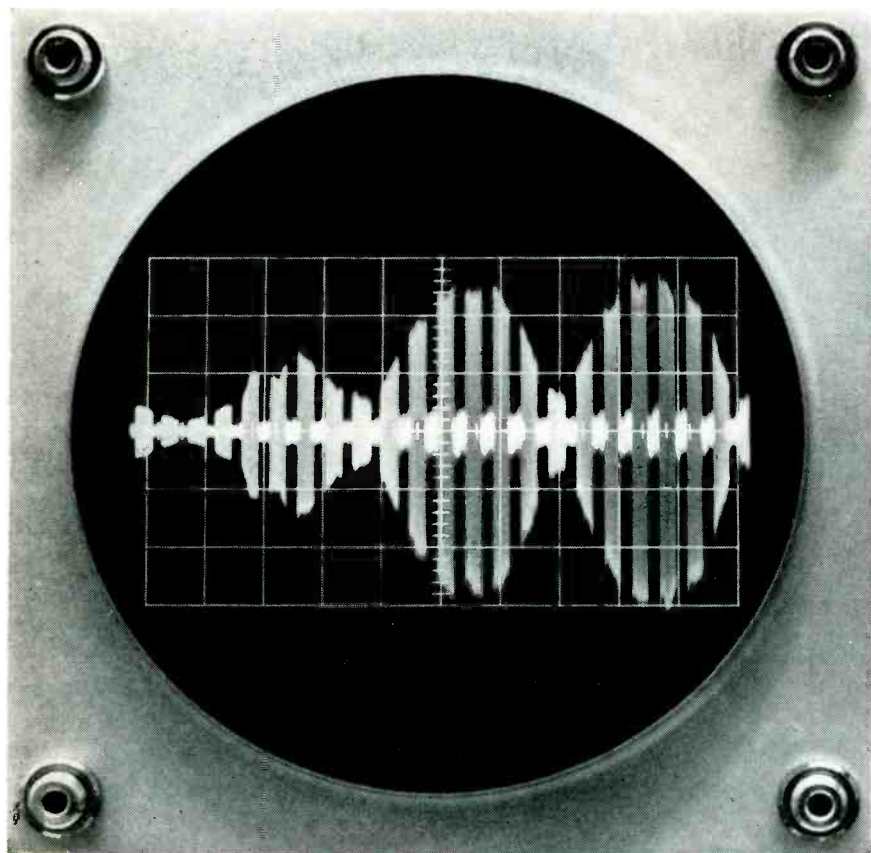

Variations in amplitude of satellite's pulses are accounted for by sphere's rotation once every six seconds

## Sputnik's Beep Baffles Scientists

WHAT DOES IT MEAN, if anything? Not only scientists but the general public as well are deeply concerned with the significance of the well publicized radio transmissions of Sputnik I.

Although there is considerable disagreement about whether coded data is contained in the satellite's transmissions, scientists and engineers in this country are gathering data feverishly. Electronic engineers at Tektronix in Portland, Oregon have made photographs of oscilloscope presentations of the beep, along with other measurements.

The signal shown in the photograph was received on a frequency of 20.005 megacycles. Height of the oscilloscope is directly proportional to signal strength, and the total horizontal sweep is equivalent to 10

seconds. The received signal was beat against an oscillator to produce a difference signal of 1.8 kilocycles.

This signal was received on Oct. 4 at 10:16 pm Pacific Standard Time. The beeps lasted for a period of 0.27 second and the pause was 0.19 second, a rate of 2.17 pulses per second. The ratio of on to off time changed from 27 to 18 by the morning of Oct. 6 to 18 to 23 and by that night to 18 to 22.

Of course, after that there were periods of sticking on one or the other transmission frequency for long periods of time.

The hypothesis that the satellite rotates once every six seconds is used to account for the three-second periods during which the pulses vary in intensity in half sinusoidal patterns.

*first in  
Performance  
Reliability  
and Quality*



the most complete line  
of POWER SUPPLIES

## TRANSISTORIZED V. R. P. S.\*

- REGULATION (for line or load) 0.03% or 0.003 Volts (whichever is greater)
- RIPPLE 3 mv. rms
- RECOVERY TIME 50 microseconds
- STABILITY (for 8 hours) 0.03% or 0.003 Volts (whichever is greater)
- 0.005% resolution with 10 turn voltage control.
- Continuously variably output voltage without switching.
- External overload and short circuit protection included.
- Either positive or negative can be grounded.
- Units can be series connected.
- Suitable for square wave pulsed loading.
- Power requirements: 105-125 volts, 50-400 cycle.
- Terminations on front and rear of unit.
- High efficiency.
- Low heat dissipation.
- Compact, light weight.
- Color: grey hammer tone.
- Suitable for bench or rack use.
- Voltmeter and ammeter provided.

### \* VOLTAGE REGULATED POWER SUPPLIES

Model	Output Volts	Output Amps.	Output Impedance Ohms		Rack Mount		
			DC-1 KC	1 KC-100 KC	W	H	D
SC-32-0.5	0-32	0-0.5	0.02	0.2	19"	3½"	11"
SC-32-1	0-32	0-1	0.01	0.1	19"	3½"	11"
SC-32-1.5	0-32	0-1.5	0.01	0.1	19"	3½"	11"
2SC-32-1.5 DUAL OUTPUT	0-32 0-32	0-1.5 0-1.5	0.01 0.01	0.1 0.1	19"	7"	11"
SC-32-2.5	0-32	0-2.5	0.01	0.1	19"	3½"	11"
SC-32-5	0-32	0-5	0.005	0.05	19"	5¼"	13"
SC-32-10	0-32	0-10	0.001	0.01	19"	8¾"	13"
SC-32-15	0-32	0-15	0.001	0.01	19"	10½"	13"
2SC-100-0.2 DUAL OUTPUT	0-100 0-100	0-0.2 0-0.2	0.1 0.1	1.0 1.0	19"	5¼"	11"
SC-150-1	0-150	0-1	0.05	0.5	19"	5¼"	13"
SC-300-1	0-300	0-1	0.1	1.0	19"	8¾"	13"



**KEPCO**  
**LABORATORIES, INC.**

131-38 SANFORD AVENUE • FLUSHING 55, N. Y.

INDEPENDENCE 1-7000

KEPCO OFFERS MORE THAN 120 STANDARD VOLTAGE REGULATED POWER SUPPLIES COVERING A WIDE RANGE OF MAGNETIC, TRANSISTOR AND TUBE TYPES. MOST MODELS AVAILABLE FROM STOCK. SEND FOR BROCHURE B-581



Model  
SC-32-0.5  
SC-32-1  
SC-32-1.5  
SC-32-2.5

also results in more efficient heat dissipation, so that probably much higher current densities can be tolerated, and strap widths can be less than values calculated allowing 300 circular mils per ampere.

A  $\frac{1}{8}$ -in. wide conductor of 2-oz copper foil can carry up to 20 amps or more without rupturing, at least under good ventilation conditions. The formulas therefore contain a high safety factor.

Table 2 shows the overload current values for various conductor sizes. These are maximum values for current surges and are not to be exceeded at any time. Normal operating currents should be closer to the values indicated in the preceding table.

► **Solder Bridging**—A spacing between conductors of at least  $\frac{1}{2}$  in. is recommended if dip-soldering or

similar techniques are to be used, since closely spaced conductors present an opportunity for short circuits due to solder bridging across the gap. Although the use of soldering fluxes reduces this danger to some extent, this minimum spacing should be maintained.

► **Voltage Breakdown** — Voltage breakdown becomes very critical at high altitudes. At sea level and 25 C the breakdown voltage for a gap with sharp edges is 1,000 volts for a  $\frac{1}{2}$  in. separation. However, at 50,000 feet and 60 C the same gap will have a breakdown voltage as low as 100 volts. Using a safety factor of 2, a good rule would be to allow  $\frac{1}{8}$  in. separation per 100 volts for equipment which may be used at altitudes up to 50,000 feet. A further safety factor results

**Table II—Overload Current and Resistance for Printed Wiring**

1-oz copper		
Width	Amperes	Ohms/in.
1/4 in.	23	0.002
1/8 in.	15	0.004
1/16 in.	10	0.008
1/32 in.	5	0.016
2-oz copper		
1/4 in.	35	0.0009
1/8 in.	20	0.0018
1/16 in.	15	0.0035
1/32 in.	8	0.007

from the fact that the printed edges do not form needle gaps, which is the condition for which these values are calculated. At ground level this factor can be increased 10 to 1.

## Engineers Work in Altitude Simulator

ENGINEERS are working at simulated altitudes of 95 miles in Beverly Hills, Calif. The altitudes are created in a high-vacuum laboratory designed by Litton Industries under Air Force sponsorship.

Two large pumps used to evacuate the chamber are believed to be capable of reducing pressure to the equivalent of 136 miles altitude. So far, a simulated altitude of 110 miles has been obtained, although

no one was in the chamber during the test. Space suits worn by personnel in the 15-foot long cylinder subject the engineers to the pressure equivalent of 27,000 feet.

The walls of the tank are made of half-inch hot-rolled steel. Port-holes enable observers to see the engineer inside. A physician watches instruments that continuously monitor blood pressure, respiration, temperature.

A major application of the high-vacuum environment is in the design of vacuum tubes. Normally adjustments are made to the elements of a tube, then the air is evacuated and the envelope sealed. After tests are made, the seal must be broken and new adjustments made or another tube with the new parameters used. The process can take months or, if new samples are used each time, it can be expensive.

In the vacuum chamber, adjustments can be made and the tube can be tested immediately since it is already operating in a vacuum. It has been found that an engineer can work in this atmosphere for as long as four hours.

Another major area in which the chamber will be used involves high-altitude weapons systems. Lubri-

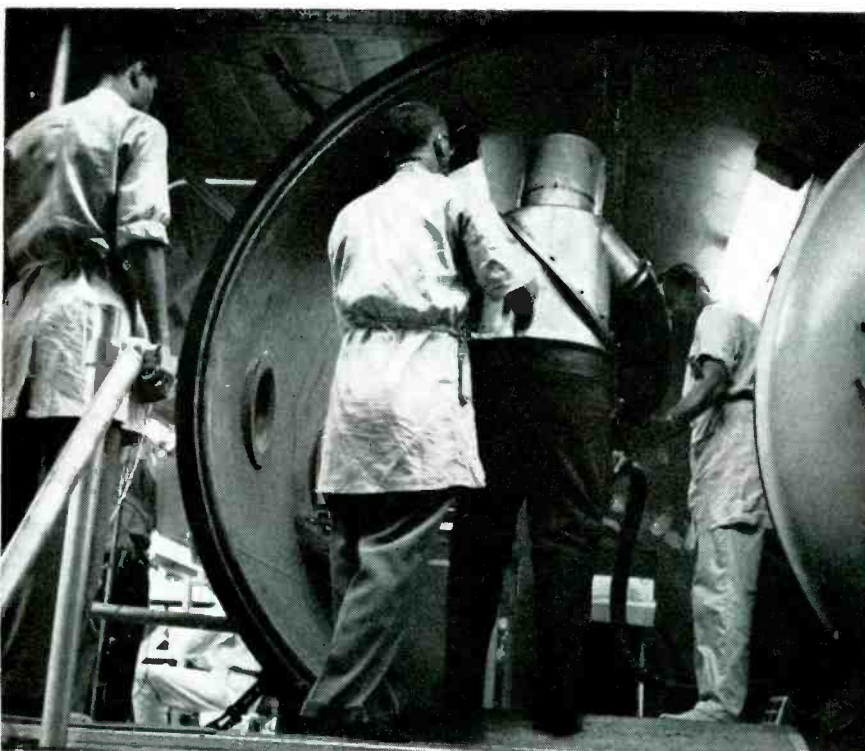

Space-suited engineer enters chamber capable of simulating altitudes of 136 miles

## PROBLEM:

Quick, silent conversion of atomic sub crew quarters to active battle station.

## SOLUTION:

Berths mounted on Grant Slides enabling immediate area "clearing".

In a submarine, every inch of space is required to perform several functions. In some cases, a battle station must also serve as living quarters for the ship's personnel. Such was the case of the recently launched third atomic-powered submarine, the U.S.S. Skate. It was found necessary to place sleeping berths in the forward torpedo room. In the event of an enemy contact, berths must be repositioned quickly, to allow space for the vital workings of the torpedo room and silently, to avoid detection by enemy sonar. Grant Slides were chosen by the Electric Boat Division of General Dynamics for this essential job and they perform it well. In addition to operating quickly and silently, the slide used had to be sturdy enough to support a sailor...again the Grant Slide specified proved the perfect answer for this important application.

Grant No. 380 Slides recommended for loads up to 500 lbs./pair

Courtesy U.S. Navy  
Electric Boat Division of  
General Dynamics Corporation

# GRANT

## INDUSTRIAL SLIDES

23 High Street, West Nyack, New York  
944 Long Beach Avenue, Los Angeles 21, California

Write for complete technical data on the wide range of Grant Slides.

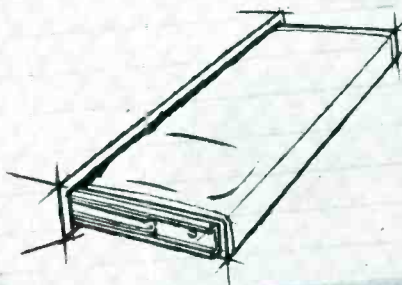
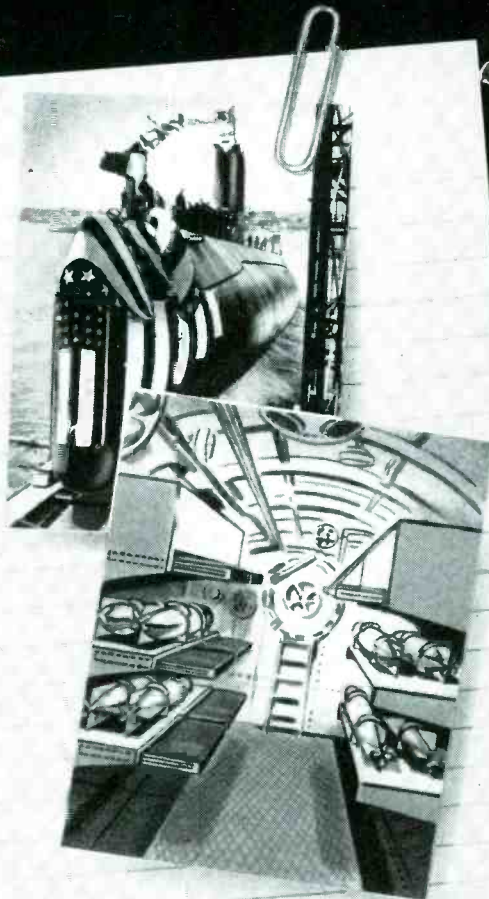

## The Front Cover

THE KLYSTRON being lowered into a test tank delivers up to 1,000,000 watts peak r-f power. Average power is 100,000 watts. The 700-pound X626 klystron is 10 feet 5 inches long.

The high-power tube is expected to increase the effectiveness of some types of radar and, in linear accelerator operation, to offer new advantages in the processing of food, chemicals, plastics and petroleum.

The X626 was designed and developed by Eitel-McCullough for Continental Electronics Mfg. under sponsorship of the Rome Air Development Center. Eitel had to provide special laboratory equipment for production, aging and testing of the new klystrons.

The lab is equipped with a special high-voltage power supply divided into two sections. One section can deliver 120,000 volts at 2 amperes, the other, 120,000 volts at 4 amperes. The two sections are housed together and can be connected in series to furnish 240,000 volts. Output can be continuously varied between 15,000 and 240,000 volts.

All test operations involving high voltage are controlled from the remote test console shown in the left of the photograph. The console enables engineers to control and adjust the power supply, tune klystrons being tested through a series of servo-mechanisms and monitor all test

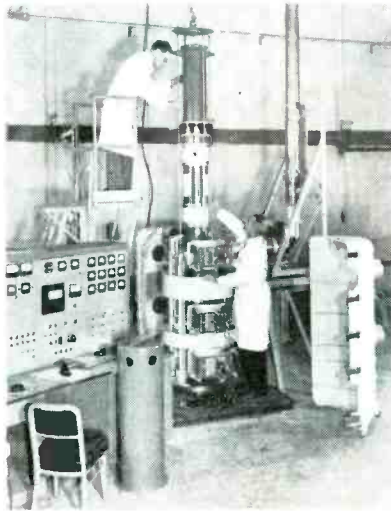

data. A key interlock system is designed to ensure that all personnel are clear of high-voltage equipment before power can be turned on.

Several test tanks with a combined capacity of 10,000 gallons of oil are used for testing and operating the klystrons. The electron gun of the tube extends below floor level into the insulating and cooling oil in the tanks.

Output of the tube is fed into a dummy water load (extending up at the right of the klystron) to dissipate the r-f energy. Over two tons of lead shielding is used to protect personnel from x-rays. The cylinder in front of the test console is part of the shielding.

The facility includes a two-ton electric hoist for handling the klystrons.

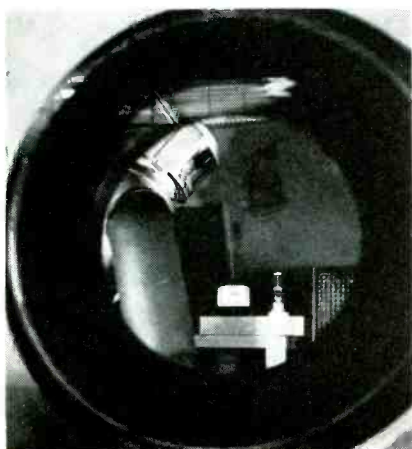

Engineer adjusts tube minus envelope in high-vacuum chamber

cants, known to vaporize at high altitudes, will be studied.

Electronics plays a part in monitoring the evacuated tank. An electron gun fires a stream of electrons inside the chamber. The stream is hardly visible because of the lack of air. If a leak occurs, however, the electron stream ionizes the gas causing a glow.

An electronic production technique is used to check the space suit each time it is used. Helium is pumped into the suit with the suit in the chamber. A Consolidated Electrodynamics leak detector in the chamber detects escaping gas.

## Extend Output With Regulated Flip Flop

By R. W. HOFHEIMER

Lincoln Laboratory  
Massachusetts Institute of Technology  
Lexington, Mass.

NEED FOR a bistable multivibrator circuit capable of producing an output having a wide voltage swing at a relatively large current occasioned the development of the regulated flip-flop shown in Fig. 1. This circuit is suitable if only one output is required instead of the two complementary outputs available from conventional flip-flops.

► **Advantages** — Primary characteristics of the regulated flip-flop are the accuracy and stability of its output. This is achieved in conventional flip-flops by using clamping circuits. The inherent difficulty encountered with clamping techniques is that when the output amplitude is increased the output impedance is correspondingly reduced thereby defeating the initial purpose of the circuit.

Stability of the output voltage produced by a regulated flip-flop with varying loads depends, to a great extent, upon the open-loop gain of the amplifier. Since gains of 1,000 or more are readily obtainable, a high degree of regulation is provided. The amplitude swing of the output is approximately 100 volts.

► **Operation**—The regulated flip-flop shown in Fig. 1 includes a conventional direct coupled, feedback stabilized amplifier. Considering only the amplifier portion of the circuit, the output voltage can be determined as follows:

$$\frac{E_{out} - E_G}{R_1} = \frac{E_G - E_{CC}}{R_2}$$

$$E_{out} = \frac{R_1}{R_2} (E_G - E_{CC}) + E_G \quad (1)$$

where  $E_{out}$  = output voltage;  $E_G$  = grid bias; and  $E_{CC}$  = bias supply voltage.

When means are provided for applying inputs consisting of successive trigger voltages having opposite polarities, the amplifier is converted into a bistable d-c amplifier. This is accomplished through the switching circuit made up of



*for your* **panel instruments**  
*depend on* **texas instruments**

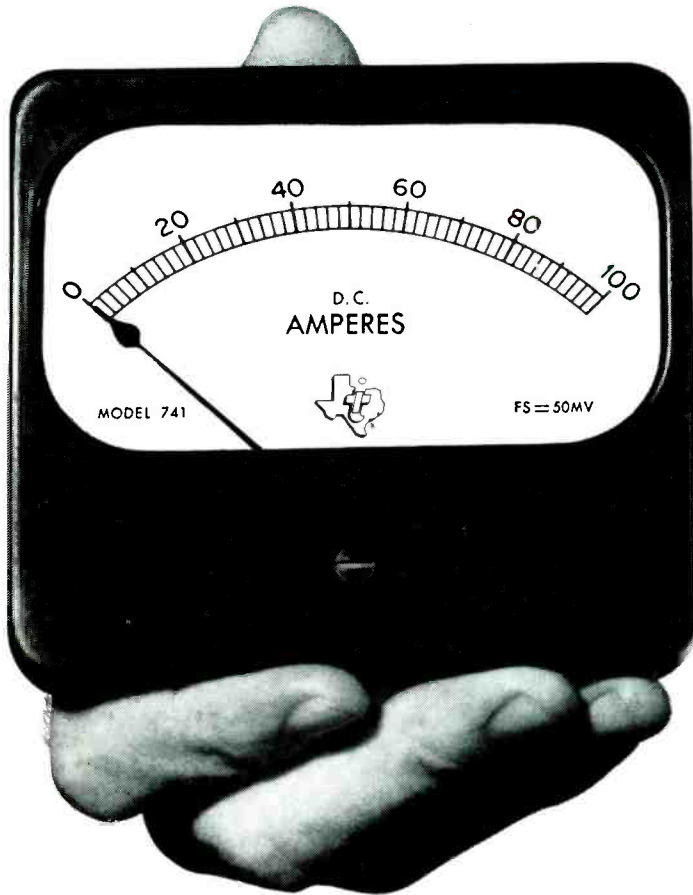

Get *immediate* prototype delivery of TI panel instruments... built to exceed MIL-M-6A or MIL-M-10304A with accuracies within 2% or less over full scale deflection and fill your panel instrument needs *now!*

**FOR THE INDUSTRY'S  
 FASTEST  
 DELIVERY!**

**movement** — ac, dc, thermocouple, rectifier, elapsed time, vu, db

**enclosure** — molded phenolic case, hermetically sealed metal case, hermetically sealed ruggedized metal case



select from  
a wide choice

**style** — front-of-board, semi-flush, flush

**size** (inches) — 1½, 2½, 3, 3½, 4¼, 4½

**shape** — square, rectangular, round, fan

**special** — modification to your specifications

**For rapid delivery of panel instruments . . . depend on Texas Instruments**

**WRITE FOR BULLETIN  
 NO. DL-C 631**



**TEXAS INSTRUMENTS  
 INCORPORATED  
 POST OFFICE BOX 312 • DALLAS, TEXAS**

# actual size of the new



# miniature microphone connectors



Illustrated above are the miniature "brothers" of AMPHENOL's world standard Series 75 microphone connectors. Designed for today's compact audio equipment and accessories, these miniatures compare in every way save size with the larger connectors.

AMPHENOL Part No.	Description	Length	Similar to Large AMPHENOL Connector
75-1	Plug	1 1/4"	75-MC1F
75-2	Jack	1"	75-MC1M
75-3	Receptacle	3/8"	75-PC1M

Simple to connect, reliable in operation, AMPHENOL's miniature microphone connectors are ready now for your use. For additional information, please write.

Authorized AMPHENOL Distributors carry complete stocks of these new connectors. For lightning-fast delivery, see your AMPHENOL Distributor!



AMPHENOL ELECTRONICS CORPORATION • Chicago 50, Illinois  
AMPHENOL CANADA LIMITED • Toronto 9, Ontario

crystal diodes  $D_1$  and  $D_2$ . The output voltage for positive input pulses can be determined by Eq. (1) and for negative input pulses can be determined as follows:

$$\frac{E_{out} - E_G}{R_1} = \frac{E_G - E_{CC}}{R_2 + R_3}$$

$$E_{out} = \frac{R_1(R_2 + R_3)}{R_2 R_3} (E_G - E_{CC}) + E_G \quad (2)$$

Introduction of positive feedback through crystal diode  $D_3$  from the output stage to the input stage converts the bistable d-c amplifier into a regulated flip-flop. The amplifier will now maintain itself in

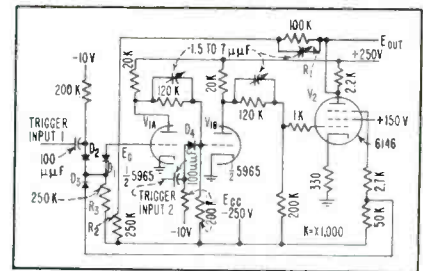

FIG. 1—Regulated Flip-Flop Circuit

either of the two states. A second trigger input through crystal diode  $D_4$  is incorporated in the final design to provide means for resetting the flip-flop.

Equations (1) and (2) demonstrate that the stability of the output voltage depends on the constancy of  $R_1$ ,  $R_2$ ,  $R_3$ , and  $E_{CC}$  and on the amount of drift exhibited by  $E_G$  in the first stage.

## Infrared Camera

AN INFRARED CAMERA capable of giving temperature indications directly from a photograph has re-

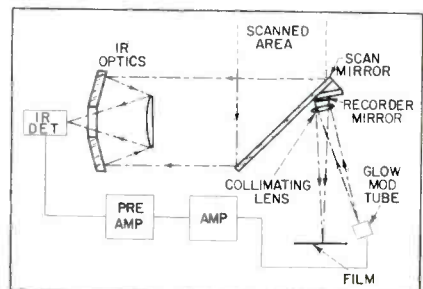
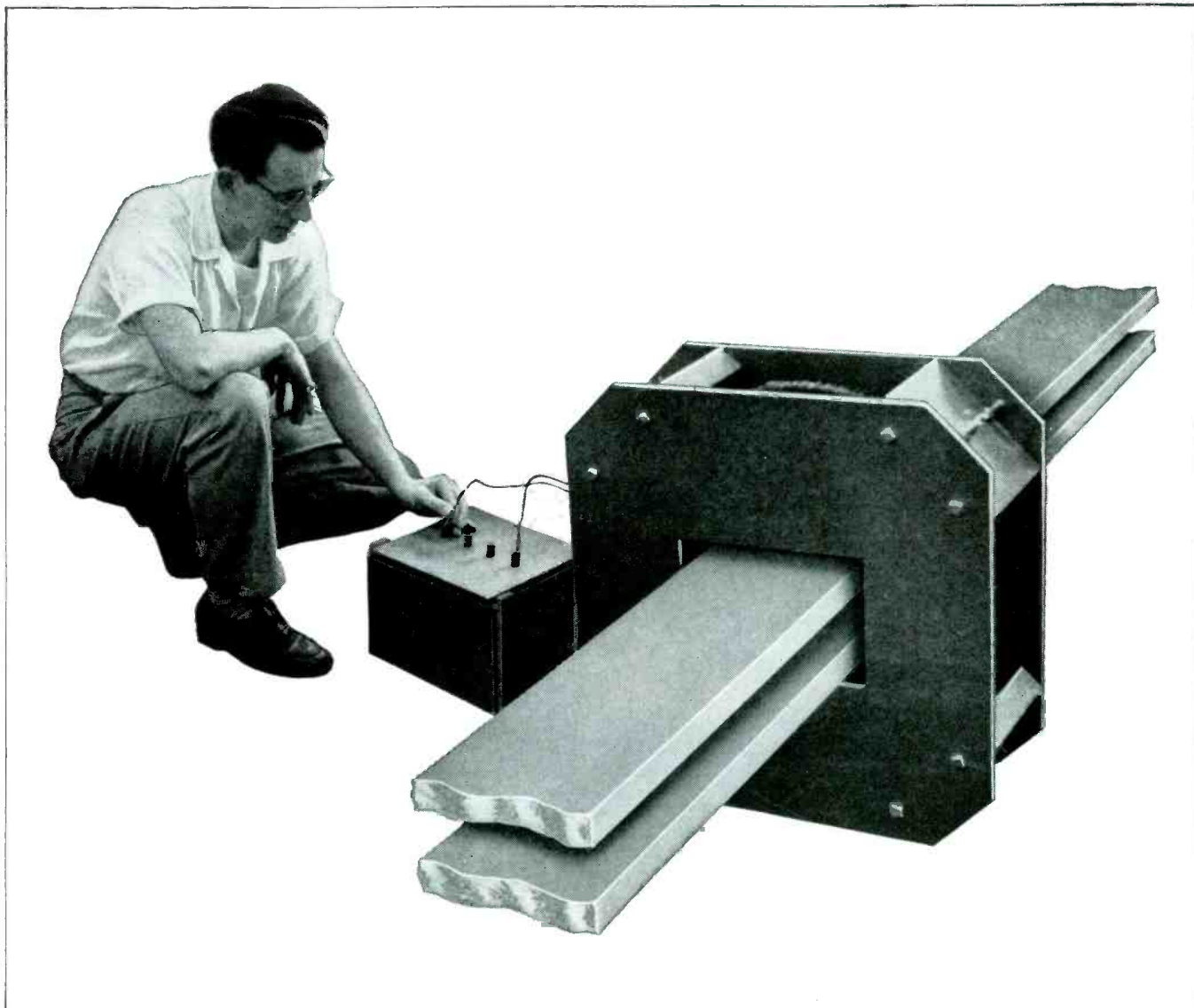

FIG. 1—Arrangement of infrared scanning system developed for photography



## Now . . . measure 200 to 10,000 amperes with isolated meters—CONTROL's Standard Transducers

CONTROL transducers have made obsolete the use of shunts for metering or recording heavy d-c loads. Now, for the first time, a standard line of transducers—nine units ranging from the 200-amp to the 10,000-amp size—make it possible for the systems engineer to measure high bus currents without direct electrical connections into the circuit.

CONTROL transducers are saturable reactors, through which the bus or cable passes. Output is linearly proportional to the bus current, with an accuracy to  $\pm 1\%$  of full scale reading. Supply voltage variations of  $\pm 10\%$  will not affect this accuracy.

In addition to eliminating the need for breaking into the circuit for connections, the CONTROL transducer has another major advantage over the shunt-millivoltmeter. The transducer will deliver relatively large amounts of power to permit such things as overload relaying and to permit a feedback signal for a magnetic amplifier.

No longer need you be dependent upon "what's available" or a special design. Catalog T-10 gives you a standard range of transducer sizes to meet your every need. For full details . . . CONTROL, Dept. E-43, Butler, Pa.

Reliability begins with **CONTROL**

A DIVISION OF MAGNETICS, INC.

TIME DELAY TIMERS

INTERVAL TIMERS

ELAPSED TIME INDICATORS

CYCLE TIMERS

**From ANY point**

## ...it's HAYDON\* for timing devices

*If you're looking for a complete product line that includes Timing Devices for every application requirement and, in addition, features the highest quality and most advanced design at the lowest possible cost, HAYDON has it! And all Haydon timing devices incorporate the famous Haydon hysteresis and/or inductor timing motors available for 50, 60, and 400 cycle and DC power supplies.*

*If you're looking for a complete service to meet all your timing needs, HAYDON offers fully integrated engineering and manufacturing facilities ready to take your timing projects right through from design and development to finished product!*

*And if you're looking for a complete Field Engineering Service to make all these facilities conveniently available, you'll find there's a HAYDON Timing Specialist in your area, a man fully qualified by training and experience to help fill your Timing Device needs. Why not phone him today and make an appointment to discuss your requirements?*

\*Trademark Reg. U.S. Patent Office

**HAYDON**  
AT TORRINGTON

A SUBSIDIARY OF GENERAL TIME CORPORATION

HEADQUARTERS FOR  
**TIMING**

**HAYDON Manufacturing Company, Inc.**  
2436 ELM STREET, TORRINGTON, CONN.



Temperature photo of man with pipe. Gray scale at top compares to temperatures of (l to r) 75.2 F, 77.4 F, 79.5 F, 83 F and 86.5 F

cently been developed. Using a thermistor and mirror scanning system, the device detects a temperature differential of 0.02 C in the scanned area. The field of scan is 20 deg horizontal and 10 deg vertical containing 30,000 resolution elements.

► **Gray Scale** — Temperatures of points in the photograph can be determined from a calibrated gray scale produced on the film during photography.

The system is shown in Fig. 1. The point scanned by a mirror is reflected through an optical system to a flake thermistor infrared detector.

The output of the thermistor is then used to modulate a glow modulator tube. The light from the tube is focussed on a mirror attached to the rear of the scanning

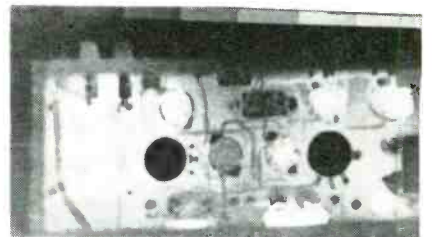
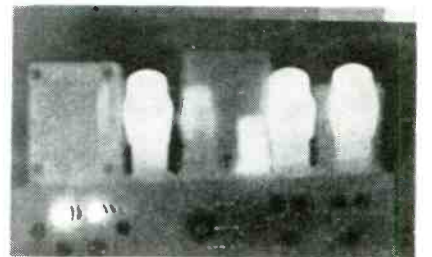

Infrared photograph of electronic chassis. Tubes are clearly outlined and transformer at left is hotter than rest of chassis

New from Clevite!

# SILICON JUNCTION DIODES

These latest additions to Clevite's complete line of computer and general-purpose diodes offer you the advantages of:

**ULTRA FAST RECOVERY TIME . . . (JAN-256)**  
(Typical: from +5.0 ma to -40v  
. . . 400K in 0.3 $\mu$ s)

**HIGH FORWARD CONDUCTANCE**  
(Typical: 50 ma at 1.5v)

**EXTREMELY LOW REVERSE CURRENT**

**FREEDOM FROM THERMAL RUNAWAY**  
at high voltage and up to 150°C

**RUGGED, HERMETICALLY SEALED GLASS PACKAGE**

**OTHER CLEVITE DIVISIONS:**

*Brush Instruments  
Clevite Ltd.*

*Clevite Ordnance  
Texas Division*

*Cleveland Graphite Bronze Co.*

*Clevite Harris Products, Inc.*

*Clevite Electronic Components*

*Clevite Research Center*

*Intermetall G.m.b.H.*

*For complete information,  
write or phone:*

## CLEVITE

**TRANSISTOR PRODUCTS**

241 Crescent St., Waltham 54, Mass.  
Twinbrook 4-9330

*A Division of*



# AMPERITE PREFERRED

by design engineers—because they're  
**MOST COMPACT • SIMPLEST • MOST ECONOMICAL**  
**HERMETICALLY SEALED**

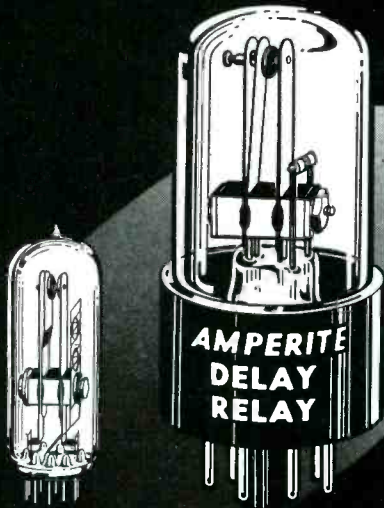

## Thermostatic DELAY RELAYS

2 to 180 Seconds

Actuated by a heater, they operate on A.C., D.C., or Pulsating Current.

Hermetically sealed. Not affected by altitude, moisture, or climate changes.

SPST only—normally open or closed.

Compensated for ambient temperature changes from  $-55^{\circ}$  to  $+70^{\circ}$  C. Heaters consume approximately 2 W. and may be operated continuously. The units are rugged, explosion-proof, long-lived, and—inexpensive!

TYPES: Standard Radio Octal, and 9-Pin Miniature . . . List Price, \$4.00.  
 Standard Delays

Also — Amperite Differential Relays: Used for automatic overload, under-voltage or under-current protection.

**PROBLEM? Send for Bulletin No. TR-81**

## BALLAST REGULATORS

Amperite Regulators are designed to keep the current in a circuit automatically regulated at a definite value (for example, 0.5 amp.) . . . For currents of 60 ma. to 5 amps. Operate on A.C., D.C., or Pulsating Current.

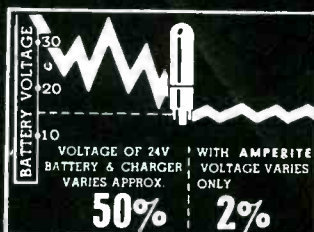

Hermetically sealed, they are not affected by changes in altitude, ambient temperature ( $-55^{\circ}$  to  $+90^{\circ}$  C.), or humidity . . . Rugged, light, compact, most inexpensive . . . List Price, \$3.00.

Write for 4-page Technical Bulletin No. AB-51



**AMPERITE CO. Inc., 561 Broadway, New York 12, N. Y.**

Telephone: CAnal 6-1446

In Canada: Atlas Radio Corp., Ltd., 50 Wingold Ave., Toronto 10

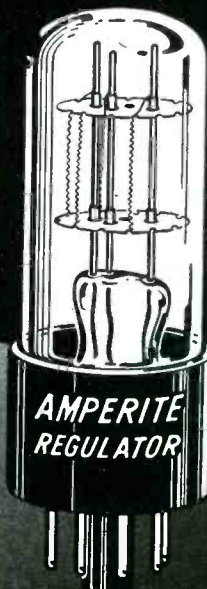

mirror and moving in synchronism with it. The mirror motion scans the glow modulator tube output across the film to make the photograph.

Typical infrared patterns taken with this equipment are shown in the photographs.

Scanning time for a complete photo can be as short as 1.9 minutes for a 10 by 10 degree field. Depending on resolution required, scan time can be up to 17 minutes.

## Phototubes Count Buses

A SYSTEM under development in London uses a photoelectric scanning system to keep track of buses as they pass check points. As described by McGraw-Hill World News, a box containing a light source and phototube is mounted on a lamp post or wall at selected points along the bus route. When a bus passes, a tape on the side of the bus reflects the light from the source back to the phototube in a coded series.

The phototube output is amplified and fed to the central control room where the bus number and location are flashed on a panel for checking.

## Solar Powered Electric Fence Charger

By G. W. ISAACS

Associate Professor  
 Agricultural Engineering Department  
 Purdue University  
 Urbana, Ill.

SILICON SOLAR CELLS are supplying energy to operate an electric fence charger in experiments at the Purdue University Agricultural Experiment station. Electric fence chargers now common on farms are powered either by connection to electric mains or by dry or storage batteries.

Connection to power mains may be impractical for fence chargers used in remote areas. Replacing of dry batteries or the recharging of storage batteries is a nuisance job sometimes forgotten by the farmer until the livestock



HIGH SPEED ELECTRO-  
MECHANICAL COUNTERS...  
SWITCH OR POTENTIOMETER  
OUTPUT COUNTER-TRANSMITTERS  
... COUNTING RATES TO  
40 PER SECOND; LIFE SPAN  
PRACTICALLY UNLIMITED...

UNITS WILL ADD AND



SUBTRACT;

FUNCTION AS EXTREMELY

EFFICIENT SUMMATION

COUNTERS... ABSOLUTE



RELIABILITY

ASSURED BY EXCLUSIVE

DIGITAC, DYNAMICALLY

BALANCED INCREMENTAL

ACTUATOR.



INSTRUMENTATION,

TELEMETERING... PRODUCTION,

QUALITY & INVENTORY



CONTROL...

AUTOMATION... COMPUTING

& BUSINESS MACHINES



... AIRCRAFT

& MISSILE READ-OUT

DEVICES & INDICATORS...

**DIGITAC, INC.**

420 South Beverly Drive

Beverly Hills, California

an affiliate of Bill Jack Scientific

Instrument Co. and

Otto Nemeth

your name .....

company .....

address .....

city .....

state .....

for detailed information, fill out and mail this page

# electronic counter

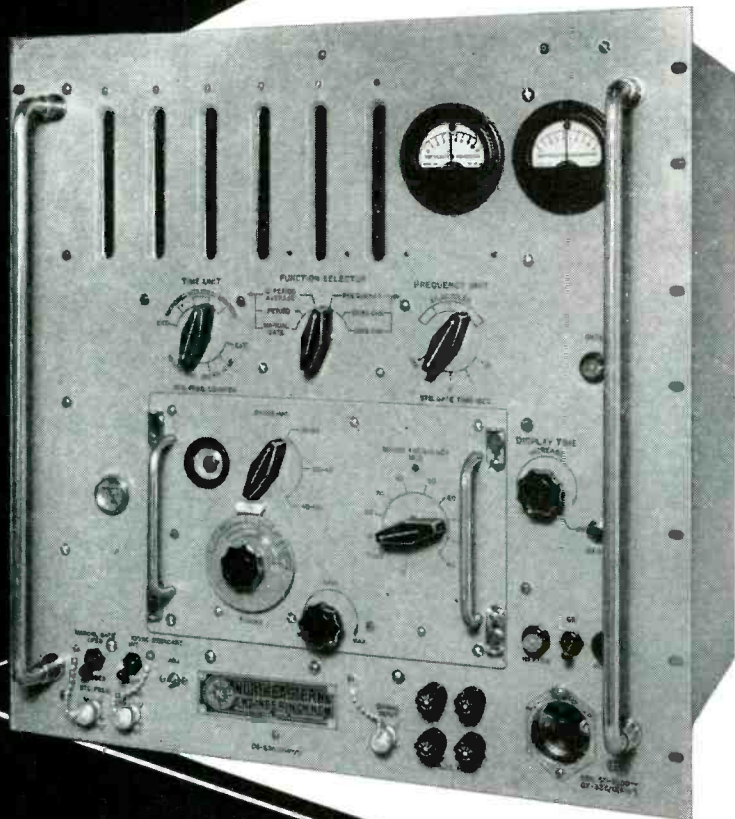

CAT. NO. — NE — 14-20 FM

ACCURATE • SIMPLE  
DIRECT READING  
INSTANTANEOUS  
RELIABLE

FREQUENCY MEASUREMENTS  
10 CPS to 220 MC; TIME  
INTERVAL 1 MS to 100 DAYS;  
PULSE LENGTH, REP, RATES,  
FREQUENCY DRIFT

**northeastern**

Manchester



**engineering**

New Hampshire

have jumped the fence because the batteries were discharged.

In the experimental application, silicon solar cells convert solar energy to electrical energy which is used to maintain the charge of a storage battery. The storage battery operates the fence charger on a 24-hour basis, whether or not the sun is shining. It is interesting to note that the solar cells will not operate the fence charger alone, even in bright sunlight, since the current required by the charger flows



Solar cells mounted on battery case supply power for electric fence

in brief peaks of high instantaneous value and spaced about one second apart. The solar cells alone cannot supply the high instantaneous current demand, but can maintain a charge on the storage battery which can supply the peak demand.

► **Circuit**—The solar cells are connected across the battery. Measurements with an integrating microammeter showed that the equivalent of 30 milliamperes of continuous current at six volts is required by the fence charger, a commercial model. Forty-eight silicon solar cells are located in a glass-enclosed frame atop the fence charger as shown in the photograph. Three groups of 16 series-connected silicon cells are connected in parallel. The storage capacity of the storage battery is sufficient for at least ten days operation of the fence charger without sunlight. Both lead-acid and nickel-cadmium storage cells have been used. The latter is probably more desirable, since it is less af-



# Extended Life and High Stability at 125°C

Please note extra performance features



## 616G - 617G - SUBMINIATURE MYLAR\* Dielectric CAPACITORS

**NEW** This ruggedly designed capacitor is a standout for stability after thousands of hours at 125°C... field tested under the severest military conditions.

**NEW** A superior capacitor element rated for accelerated life testing twice that applied to conventional metal enclosed tubulars.

**NEW** Formed Mylar insulators prevent leakage to the case and contribute to the high IR which characterizes these designs. \*DuPont's trademark for polyester film.



### SPECIFICATIONS

**Long Term Stability**—Extensive testing indicates capacitance change is less than 1% after 5000 hours operation at rated voltage and 125°C

**Life Test**—500 hours at 125°C and 125% of rated voltage

**Insulation Resistance**—See curve below for typical performance

**Temperature Immersion**—Meet requirements of MIL-C-25A for 125°C (Characteristic K)

**Mechanical Properties**—Meet all requirements of MIL-C-25A

**Capacitance Change with Temp.**—See curve below for typical performance

#### 616-G (One Lead Grounded to Case)

Cap. In.	50V	150V	400V
Mfd.			
.001	.173 x 1/4	.173 x 1/4	.193 x 1/4
.0047	.173 x 1/4	.193 x 1/4	.233 x 1/4
.01	.193 x 1/4	.233 x 1/4	.312 x 3/4
.047	.312 x 1/4	.312 x 1/4	.400 x 1 1/4
.1	.400 x 3/4	.400 x 1 1/4	.562 x 1 1/4

#### 617-G (Both Leads Insulated From Case)

Cap. In.	50V	150V	400V
Mfd.			
.001	.173 x 3/4	.173 x 3/4	.193 x 3/4
.0047	.173 x 3/4	.193 x 3/4	.233 x 3/4
.01	.193 x 3/4	.233 x 3/4	.312 x 3/4
.047	.312 x 3/4	.312 x 3/4	.400 x 1 1/4
.1	.400 x 3/4	.400 x 1 1/4	.562 x 1 1/4

Insulation Resistance vs. Temp  
Degrees Centigrade

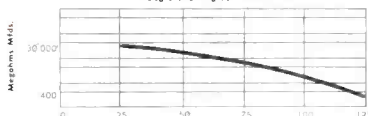

Capacitance Change vs. Temp  
Degrees Centigrade

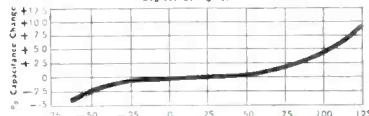

TECHNICAL BROCHURE AVAILABLE ON REQUEST



GOOD-ALL ELECTRIC MFG. CO.

OGALLALA, NEBR.



GOOD-ALL CAPACITORS NOW AVAILABLE AT YOUR LOCAL DISTRIBUTOR.

# LAPP

## GAS-FILLED CONDENSERS

for duty at

**High Voltage**

**High Current**

**High Frequency**

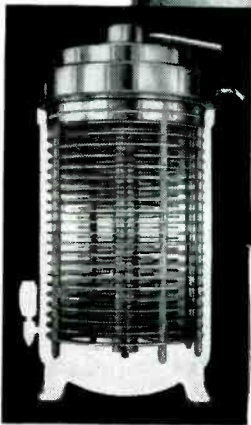

Lapp's experience of 18 years of design and manufacture of gas-filled condensers is back of this precision-made unit and its promise of years of trouble-free duty. It is small in size and low in loss,

offers high voltage and current ratings, high frequency limits, safety, puncture-proof operation and constant capacitance under temperature variation.

The entire electrical and mechanical assembly of the Lapp gas-filled condenser is supported by a top aluminum ring, the steel tank serving only as a support for this ring and as a leak-proof gas container. High-potential plates are carried on a rigid center stud which is supported by a top ceramic bowl. Grounded rotor plates are carried on ball bearings nearly the full tank diameter. This construction provides a grounded tuning shaft on variable models and makes possible efficient and complete water cooling for high current operation.

Models in four tank diameters, 7" to 18", are available, in variable or fixed capacitances, for duty up to 30,000mmf; in current ratings to 400 amps at 1mc; operating voltages to 80Kv peak. Write for Bulletin 302, with complete description and characteristics data. Lapp Insulator Co., Inc., Radio Specialties Division, 137 Sumner Street, Le Roy, N. Y.

# Lapp

ELECTRONS AT WORK

(continued)

ected by periods of overcharging.

More efficient use could be made of the solar cells if they could be automatically disconnected from the circuit when the sun is not shining and they are not charging the storage battery. If they are not disconnected, the solar cells draw current from the battery at a very significant rate when the sun is not shining. A reverse current relay similar in operation to that used on automotive electric systems could be used, but it would have to be rather sensitive, costly and would require some energy to operate.

An arrangement currently being evaluated uses a thermostat in series with the solar cells. The thermostat is set just above the highest expected night-time temperature so that it opens the circuit at night and on most cloudy days. When the sun strikes the thermostat, it closes the circuit and allows the solar cells to charge the storage battery. The thermostat is painted black for maximum solar energy absorption and enclosed under glass to protect it from the cooling effect of the wind. A transistor diode is also being considered for this application.

### Meter Shows Current Drift from Nominal

By DAVID T. GEISER

*Sprague Electric  
North Adams, Mass.*

CURRENT stability is often difficult to measure because variations are usually small compared to the steady value and even smaller in comparison with the full-scale value of the ammeter that must be used.

However, measurements of small variations in current are important in constant-current applications such as transistor test power supplies and timing circuits, as well as any place where changes in electrical power or rate of energy transfer are significant.

The circuit described was built to monitor deviations in current in test and control circuits. This is

# How a tape recorder on wheels does multiple duty

## Complete make-ready at test cells in less than an hour

Here is a whole "dynamic-data recording facility" that can be rolled into place as easily as coffee and doughnuts. It is the familiar pushcart — but in this case glorified into a versatile system of roving instrumentation.

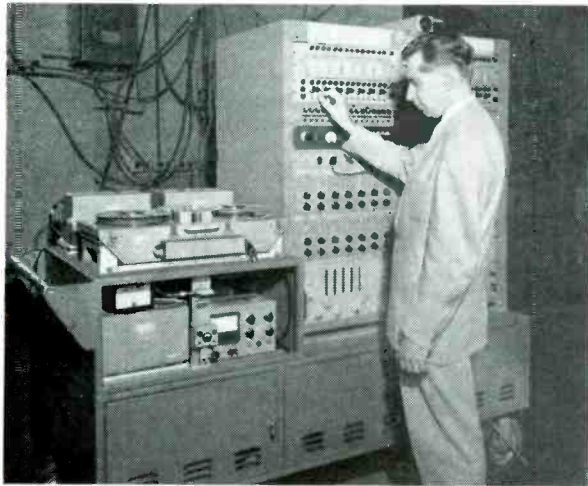

*Ampex 800 Mobile Tape Recorder and other equipment mounted together on a dolly at General Electric's Small Aircraft Engine Department.*

### 42 TAPE TRACKS CAN CONVERGE ON A SINGLE TEST

For its own use, the Small Aircraft Engine Department of General Electric developed this dolly-mounted tape system to circulate among a number of test cells. Each dolly carries an Ampex 814, fourteen-track recorder, and all related calibrating, amplifying and monitoring equipment. Three are shared among the many engine test cells . . . or all can be used at once on the same test, making 14, 28 or 42 tape tracks available on any engine run as needed.

### INTERCONNECTED EQUIPMENT SAVES TIME

During lengthy engine setups, there is no tape recording equipment tied up at the test cell. When the engine is ready, the recording equipment is connected in less than an hour. Everything on the dolly is permanently interconnected, hence only external hookup need be made. Formerly, when this instrumentation was brought in in pieces, it was an all day job.

Data recorded on this mobile system include turbine-blade stresses, vibrations, control responses and dynamic temperatures and pressures. Data frequencies range up to 3000 cycles per second. By slow playback, magnetic tape brings these down within the limits of direct-writing instruments of only 100-cycle response. The dynamic information gained in this way has greatly aided the development of small turbo shaft engines of remarkable power-to-weight ratio. One of these, General Electric's T58, produces 1024 horsepower from only 325 pounds of engine weight (including a 75 pound reduction gear).

### A CHOICE OF RECORDERS FOR MOBILE USE

The Ampex 814 is extremely compact. The 14-track recorder occupies only three cubic feet and weighs only 140 pounds. It also has factory-furnished shock mounting and is of exceptionally rugged structure.

Though Ampex's FR-100 and FR-1100 laboratory tape recorders are much larger, they too can be mounted on dollies or trailers. They record and reproduce, have more modes of tape travel, and require only 117-volt, 60-cycle power.

All of these Ampex recorders have interchangeable plug-in amplifiers and a wide choice of tape speeds. These features accommodate the changing requirements that are likely in moving from test to test.



*Mobility of another size — an Ampex FR-100 recorder (left foreground) in a large instrumentation trailer designed by General Electric's Missile and Ordnance Systems Department for firing range use. FR-100s are sometimes used on small dollies too.*

*A new brochure on the Ampex 800 Mobile and Airborne Recorder has just been published. May we send you a copy? Literature is also available on other models, and recommendations can be made on specific applications. For any of these requests, write Dept. E-12.*



*Series FR-100*



*Series 800 Mobile and Airborne*



*Model FR-200 Digital*



*Series FL-100 Loop Recorder*



*Series FR-110Q*

INSTRUMENTATION  
DIVISION

AMPEX  
CORPORATION

FIRST IN MAGNETIC TAPE INSTRUMENTATION

934 CHARTER STREET · REDWOOD CITY, CALIFORNIA

District offices serving all areas of the United States and Canada; Foreign Representatives in countries around the world.



# DATA from a DUMMY

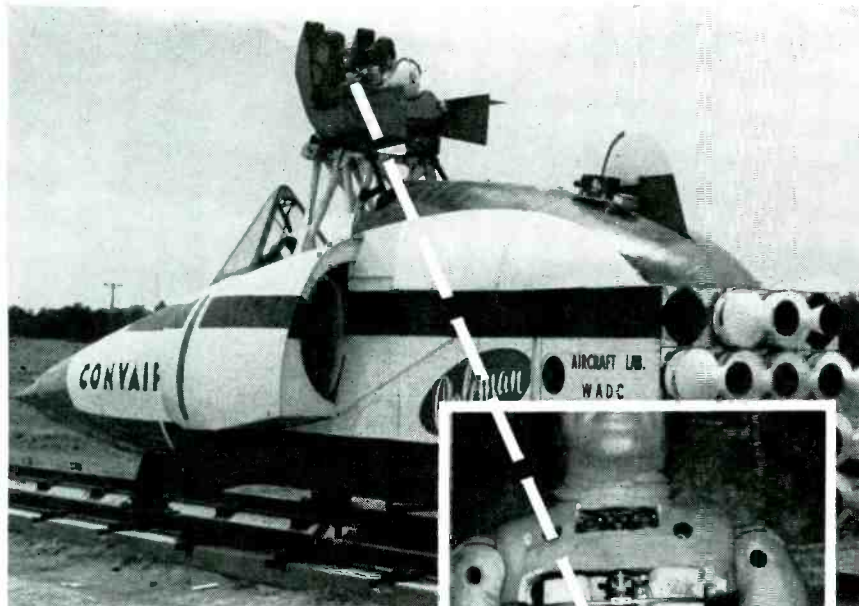

## with an FM TELEMETRY Transmitter

Sensitized for human reactions, this dummy helps collect human factor data for development of ejection seats for supersonic jet aircraft. The full-scale rocket sled tests are one phase of the industry-wide program to develop a safe standardized pilot escape system for the Air Force.

The Model 3021 Transmitter used in these tests is a rugged subminiaturized unit designed for high shock impact and extreme environments.

**Frequency** - 215-235 mc  
**Power Output** - 2 watts  
**Weight** - 1.7 pounds

Write for complete data and prices to P. O. Box 37, Melbourne, Florida

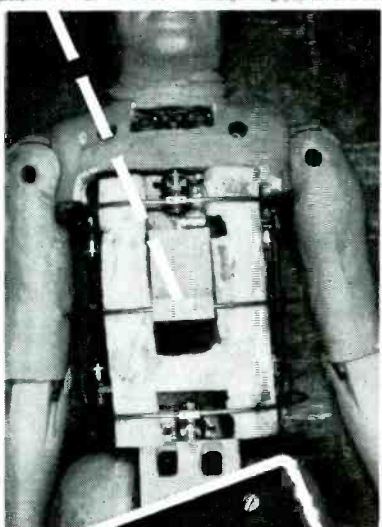

# RADIATION INC.

MELBOURNE AND ORLANDO, FLORIDA  
ELECTRONICS • AVIONICS • INSTRUMENTATION

Personnel Inquiries Invited.

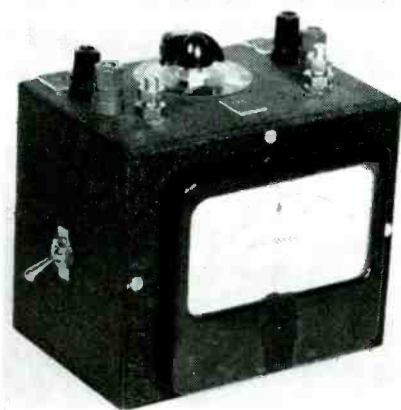

Meter shows current deviations 100 microamperes either side of nominal current in circuit being monitored

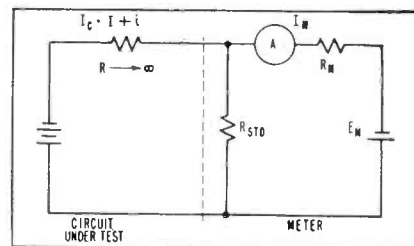

FIG. 1—Only deviations from nominal current ( $I$ ) pass through meter

done by effectively subtracting the nominal current from the actual current and indicating the difference directly on a meter.

In Fig. 1,  $I_c$  is actual current in a source of nearly constant current,  $I$  is the steady portion and  $i$  the deviation.

For zero milliammeter indication,

$$I_c = I \text{ and } E_m = IR_{std}$$

By superposition

$$\begin{aligned} I_m &= \frac{(I + i) \frac{R_{std} R_m}{R_{std} + R_m}}{R_m} - \frac{IR_{std}}{R_{std} + R_m} \\ &= \frac{(I + i) R_{std}}{R_{std} + R_m} - \frac{I R_{std}}{R_{std} + R_m} \\ &= \frac{i R_{std}}{R_{std} + R_m} \end{aligned}$$

where  $E_m$  is voltage across meter,  $R_{std}$  is resistance standard and  $R_m$  is meter resistance.

This shows that the meter indication is proportional only to the variable part of the metered current.

► **Design** — The meter voltage source,  $E_m$ , should be a constant-impedance supply with adjustable output voltage. In the illustrated model dry cell batteries are used and voltage is varied with a constant-impedance attenuator. Enough se-

Another CEC first...

# a new rectangular connector with exclusive snap-in contacts

First in the field, CEC's exclusive snap-in contacts lock in place, yet can be removed quickly, easily as illustrated. The advantages of this new concept are unexcelled: Wire can be attached to contacts by crimping or soldering before assembly. You can capitalize on semi- or fully automatic crimping methods. Pins and sockets are interchangeable in the same connector body. Exclusive split hood is rigid, has fewer small parts, speeds assembly, facilitates inspection. You make *big savings* in time and money, drastically cut assembly and field maintenance costs.

**MEETS MIL-C-8384A** Specifications. Also physically interchangeable and will mate with ordinary connectors having similar contact arrangements.

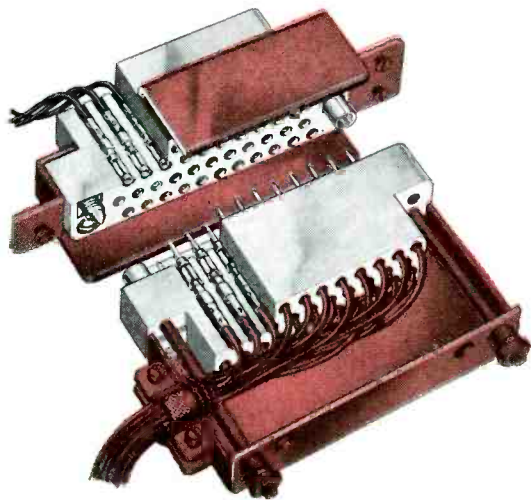

**EVALUATION UNITS** available from stock—Order now. For complete information, write today for BULLETIN CEC 4004-X10.



NO TAPERED PINS, NO DAMAGED CONNECTORS. SIMPLE EXTRACTOR TOOL QUICKLY REMOVES CONTACT AS ILLUSTRATED IN 3 VIEWS BELOW.

1. EXTRACTOR TOOL ENTERS FRONT FACE.
2. TOOL'S OUTER SLEEVE DEPRESSES RETENTION SPRING AND BOTTOMS ON RETENTION SHOULDER.
3. CONTINUOUS FORWARD MOTION EXTENDS INTERNAL PLUNGER AND SLIDES CONTACT OUT.

THE EXCLUSIVE RETENTION SPRING RESISTS MORE THAN 15 LBS AXIAL PULL PER CONTACT.

RETENTION SHOULDER WITH CONTACT REMOVED.

YOU CAN CRIMP OR SOLDER BEFORE ASSEMBLY. ADAPTABLE TO AUTOMATIC CRIMPING METHODS.

## Consolidated Electrodynamics

Glendale Division



740 Salem Street, Glendale 3, California

OFFICES IN PRINCIPAL CITIES THROUGHOUT THE WORLD

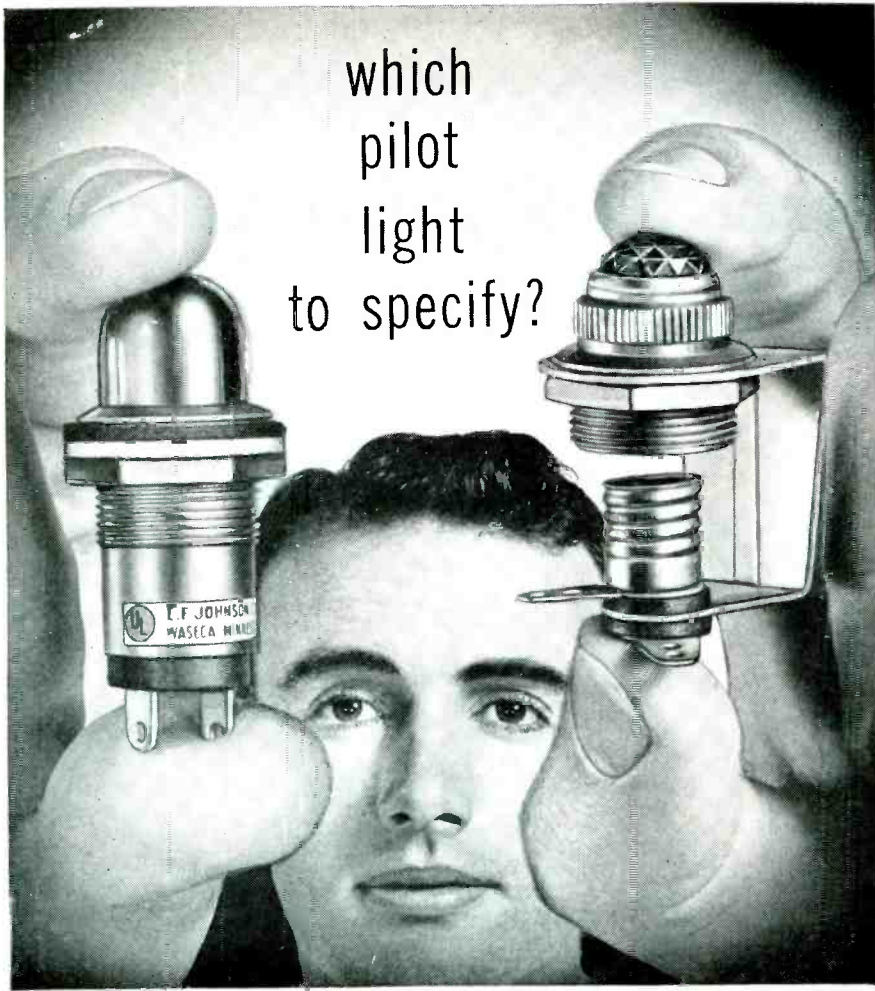

which  
pilot  
light  
to specify?

here's a  
quick, easy way  
to find the  
answer!

Save valuable specification time by selecting your panel indicators from Johnson's "preferred" line. This group contains over 47 separate assemblies carefully selected from Johnson's standard line by many of the nation's top design and development personnel. Available in a wide variety of types, these "preferred" units are immediately available at parts distributors throughout the country, for original equipment or in-the-field replacement. Write for your free copy of Johnson's newest pilot light specification catalog — see how easy it is to select the *right* pilot light . . . fast!



free!

New pilot light catalog — contains complete specifications, prices and technical data . . . everything you need to select the proper unit for original equipment or in-the-field replacement.

Available types include: continuous indication neon types; models for high and low voltage incandescent bulbs; standard or wide angle glass and lucite jewels in clear, red, green, amber, blue or opal. Specials, including those meeting military specifications are also available in production quantities.

**E. F. Johnson Company**

2308 SECOND AVENUE S. W. • WASECA, MINNESOTA

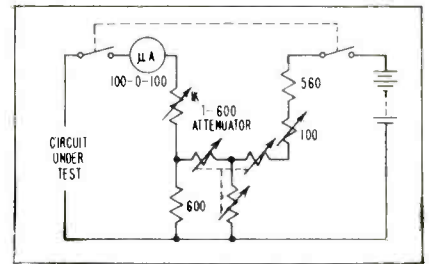

FIG. 2—Using a 45-volt battery in this circuit, steady currents from one to 50 ma can be balanced so that deviation current can be measured

ries resistance is used with the battery to equal attenuator impedance, and the attenuator is accurately terminated. This gives a variable voltage source with very close to 300-ohms internal impedance at small cost.

A current-deviation range of  $\pm 1$  ma was desired. For a 200-ohm  $R_{std}$ , the meter resistance,  $R_m$ , should be 1,800 ohms, using a 100-0-100 microammeter. The 300-ohm voltage source and 1,000-ohm meter required 500 ohms more, which is supplied by a variable resistor.

Operation with a 45-volt battery permits balancing out steady currents of one to fifty milliamperes with the circuit shown in Figure 2. Somewhat greater ease of balance is obtained by using a tapped battery and selecting voltages that permit balance in the low-attenuation portion of the T attenuator.

Accuracy measured is approximately three percent of full-scale deviation, 3 microamperes in this case, over the full range of steady current. Recalibration has not been found necessary after the battery and meter resistors have been adjusted.

A momentary on-off-on switch is recommended for ease of instrument use.

## VHF Rheostat

By W. B. WRIGLEY and  
T. R. SCOTT, JR.

Engineering Experiment Station  
Georgia Institute of Technology  
Atlanta, Georgia

EXTENSION of the frequency range-of crystal impedance meters to very high frequencies has emphasized the need for low-phase-angle vhf rheostats. The resistors presently

*faced with a tough design problem?*

*Rugged*  
**ALSiMAG<sup>®</sup>**  
**ALUMINA CERAMICS**  
*may be the answer!*

For exacting applications, your chances are better with ALSiMag because more special-characteristic Aluminas are available here than from any other source. You benefit from extra "know-how" — 25 years of experience in producing simple and complicated Alumina parts in a broad range of shapes and sizes — plus equipment for rapid delivery in any quantity. Precision tolerances. Prototypes before tooling, if you like.

Advantages like these give you greater freedom: Tensile strengths up to 25,000 lbs./sq. in. Compressive strengths up to 420,000 lbs./sq. in. Flexural strengths up to 62,000 lbs./sq. in. Superior electrical characteristics. Safe operation at continuous temperatures up to 2952° F. Loss factors as low as .0074 at 10,000 MC.

Not all applications need such advanced properties. A standard ALSiMag material—from the industry's widest selection—may meet your specifications. Let us help match your requirements to the ALSiMag material that will do the job at lowest cost. Premium ALSiMag Aluminas will be suggested only where superior performance is needed. Send blueprint or sketch with details of operating conditions.

A Subsidiary of  
Minnesota Mining and  
Manufacturing Company



**AMERICAN LAVA**  
**CORPORATION**

CHATTAHOOGA 5, TENN.

56TH YEAR OF CERAMIC LEADERSHIP

For service, contact Minnesota Mining & Manufacturing Co. Offices in these cities (see your local telephone directory): Atlanta, Ga. • Boston, Newbury Center, Mass. • Buffalo, N. Y. • Chicago, Ill. • Cincinnati, O. • Cleveland, O. • Dallas, Texas • Detroit, Mich. • High Point, N. C. • Los Angeles, Calif. • New York, Ridgewood, N. J. • Philadelphia, Pa. • Pittsburgh, Pa. • St. Louis, Mo. • St. Paul, Minn. • San Francisco, Calif. • Seattle, Wash. Canada: Minnesota Mining & Manufacturing of Canada, Ltd., P. O. Box 757, London, Ont. All other export: Minnesota Mining & Manufacturing Co., International Division, 99 Park Ave., New York, N. Y.

# for LASTING RELIABILITY!

MODEL 318  
or 318 A  
AMPLIFIER

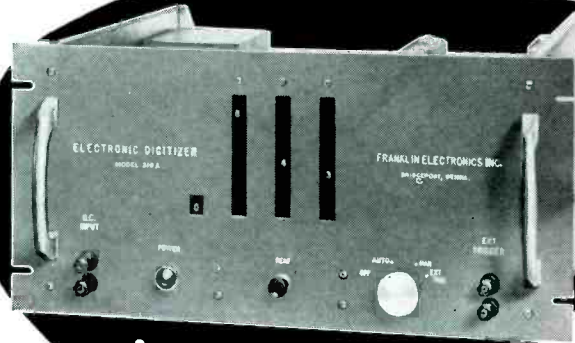
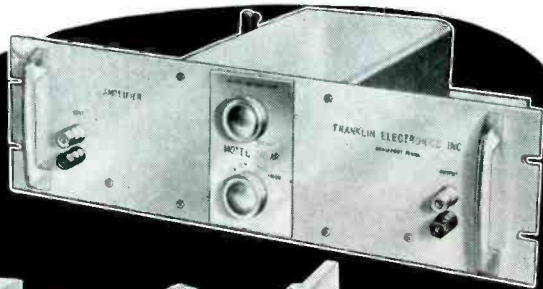

Both

ONLY  
\$2370<sup>00</sup>  
FOB

*You Need the*

MODEL 310 A  
ALL ELECTRONIC  
DIGITIZER

## Franklin All Electronic Digital Voltmeter

5 COMPLETE READINGS/SEC • ACCURACY 0.1% Full Scale

### MODEL 310 A DIGITAL VOLTMETER WITH MODEL 318 AMPLIFIER

**Accuracy:** Plus one count, minus nothing. (0.1% of full scale.)

**Range:** X1, 0.1 V to 120.0 V.  
X10, 0.01 V to 12.00 V.  
X100, 0.001 V to 1.200 V.  
X1000, (318 A Amp. only) 0.0001 V to 0.1200 V.

**Input, Impedance to Amplifier:** 318, 1 megohm.  
318 A, 100 K ohms.

**Speed:** Adjustable from 5 complete readings per second down. (310 A Digitizer alone: from 60 complete readings per second down.)

**Reading modes:** Manual—triggered by push button.  
Automatic—self triggering at 10 readings per second.

External—by relay closure.

External trigger—reads on applications of 20 volts minimum pulse with 5 volts per micro-second rise time.

**Outputs:** Visual—4 illuminated decimal digits. (First digit: zero or one.)

Stair case code—a nine is approximately 55 volts; a zero is approximately 130 volts.  
Time gate—linearly proportional to input voltage (100 microseconds per volt.)

The Model 310 A is the voltmeter you've been looking for to provide you with reliable readings without periodic factory adjustments. It is designed, built and proven for making reliable production line and laboratory precision voltage measurements from 0.0001 volts DC to 120.0 volts DC in four ranges.

This versatile all electronic digitizer can also be used as an analog to digital conversion element in data reduction systems and for measuring strain, pressure, temperature, and motion.

The 310 A with 318 amplifier will connect directly to the new Hewlett Packard Model 560 A Printer giving Five Complete Readings per sec.

**AVAILABLE FROM STOCK  
FOR ADDITIONAL  
INFORMATION  
WRITE TO DEPT. 310**



Franklin Electronics, Inc.

BRIDGEPORT, PA.

*Electronic & Nuclear Development  
& Manufacturing*

used as substitution elements in CI meters are unsatisfactory because of the reactive effects that may introduce appreciable error in frequency and resistance measurements. In addition, the use of fixed resistors requires interpolation between successive resistances for most crystal parameter measurements.

To overcome the limitations of fixed resistors, a series of vhf rheostats has been developed that minimize the reactive effects and being continuously variable eliminate the

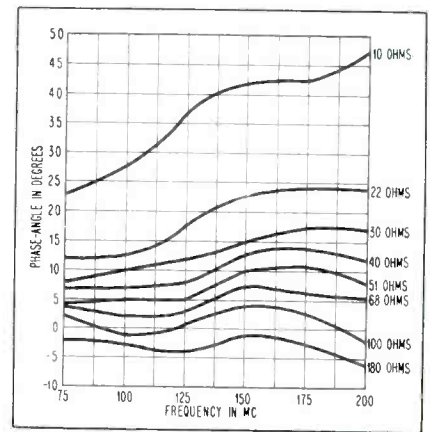

FIG. 1—Characteristic curves of a commercial resistor

necessity of interpolation. With these rheostats, satisfactory CI meter operation has been obtained up to 200 mc, indicating suitability for other similar vhf applications.

The acceptable phase-angle tolerance for resistors used in the CI meter was established in terms of the Q and the frequency tolerance of the crystal unit to be measured. In the substitution resistance method of determining the equivalent electrical parameters of a quartz crystal, various resistors are substituted for the crystal in an oscillator until a resistor is obtained that gives the same frequency of oscillation and the same oscillator grid current as the crystal.

Under these conditions, the crystal and resistor appears essentially the same to the oscillator. Since the resistor may have a non-zero phase-angle, the crystal will also be operating at a phase-angle other than zero. The maximum phase-





for combination navigation and automatic pilot systems in airliners • for inertial guidance systems in guided missiles • for inertial navigation systems in military aircraft

see **AC**

*... volume producing*

**g y r o s c o p e s**

*... setting the world's highest standards of quality*

Several manufacturers today can and do build precision-made gyroscopes. Others may produce less precisely-made gyros in volume. But, AC is the only maker of gyroscopes to produce both highest quality and highest volume! These gyros are held to such close tolerances in manufacture that the finished product can instantly sense rotation so slight that it would take years to complete a full circle. Yet they are durable enough to withstand 5,000 to 7,000 hours of continuous operation without appreciable loss of sensitivity. Sizes now available for immediate delivery include  $75 \times 10^6$ ;  $10 \times 10^6$ ;  $2 \times 10^5$ ;  $1 \times 10^4$ .

Wanted: Graduate engineers with electrical, mechanical or electronic backgrounds. Contact Mr. Cecil Sundeen, Supervisor of Technical Employment, in care of **AC . . . the Electronics Division of General Motors, Milwaukee, Wisconsin.**

**Afterburner Fuel Controls • Bombing Navigational Computers • Emergency Fuel Controls • Gun-Bomb-Rocket Sights • Gyro-Accelerometers • Gyroscopes  
Inertial Guidance Systems • Manifold Air Pressure Regulators • Speed Sensitive Switches • Speed Sensors • Three-Way Selector Valves • Torquemeters**



*In a hedgehog hodgepodge of dials, meters,  
indicators, lights, knobs and switches,  
Beckman Linear Scale Ammeters still read*

## RIGHT AT A GLANCE

BECKMAN LINEAR SCALE AC AMMETERS pop right out of clutter and confusion to read right at any angle, any distance. The expanded scale tells the full story, even when there's barely time for a peck.

WHAT'S THE SECRET? Linear scale: More accurate because graduations are evenly spaced instead of huddled together foolishly at one end of the scale; more legible because the needle position tells the tale at a glance, without any discussion. And there's no disturbing distortion from shadows, wherever the pointer points.

IS THERE A TRANSFORMER? Glad you asked. The special current transformer, which converts AC current to 5-ma. level, can be more than 150 feet from the meter without hurting a thing. Meter and transformer—both completely scaled—have a combined weight of 22 oz.

SOME SPECS? Accuracy:  $\pm 2\%$  from 325 to 475 cycles.  
Frequency: 400 cps nominal. Meter range: 0 to 115 amps.  
Volt-ampere consumption: less than 0.05 va at full scale.  
Ambient temp. range:  $-55^{\circ}$  to  $+71^{\circ}$  C.

ALL THE DETAILS? Write for data file 124A.

**Beckman** Helipot  
Corporation

Newport Beach, California  
A division of  
Beckman Instruments, Inc.  
Engineering representatives  
in principal cities

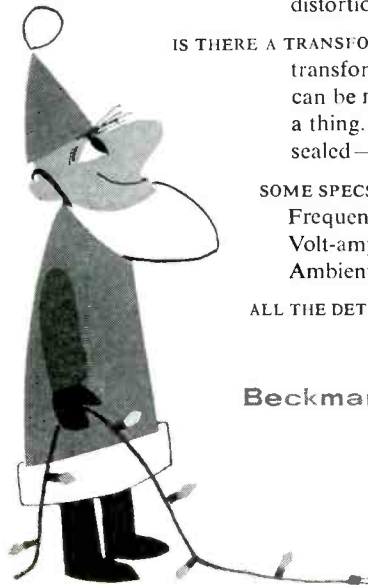

angle that can be tolerated before unacceptable errors are introduced may be determined from the expression for the phase-angle of the impedance of a series resonant circuit.

For an assumed crystal  $Q$  of 10,000 and an established frequency tolerance of 0.001 percent, resistors or rheostats exhibiting phase-angles of  $\pm 11$  deg or less may be considered satisfactory as substitution elements for quartz crystals in CI meters.

Of the resistors tested, the commercial units for which curves are shown in Fig. 1 exhibited the most satisfactory phase-angle characteristics. However, at low resistance values, the need for some form of reactive compensation is apparent since the phase-angles exceed 11 deg. Even though the low resistance values could be compensated, the necessity of interpolation further limits satisfactory utilization of fixed resistors. Consequently, efforts were directed toward the development of a suitable variable resistor.

The phase-angle characteristics of resistors are primarily deter-

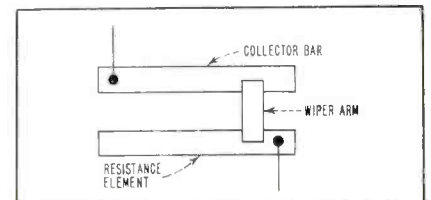

FIG. 2—Method of maintaining constant path length.

mined by the stray inductive and capacitive reactances associated with the resistive element. In variable units, the additional problem of varying reactance is encountered.

In any satisfactory low-phase-angle variable unit it is desirable that these reactances be minimized and furthermore be maintained constant throughout the resistance range. A constant electrical path length is required if the effect of varying inductance with resistance setting is to be overcome. Figure 2 shows a method of maintaining a constant electrical path length.

An experimental model vhf rheo-

# POCO TIEMPO IS SPECIAL!



**Special group!** With its own coil-winding, machining and assembly facilities.

Its own sales, engineering, purchasing, inspection and shipping activities. Its own everything

but red tape. **Special orders!** Potentiometers, in prototype quantities, with these

special modifications: resistance values, tolerances, linearities, taps, shafts, lids, bushings, ganged

assemblies, torque, bearings and rotation. Take your pick. **Special Delivery!** In 10 days

or less. **Special price?** No! Not one cent extra! *For your non-standard prototype pots,*

*go fast, go first-class, go Poco Tiempo! Ask for it by name.*

Beckman<sup>®</sup> / Helipot

Helipot Corporation, Newport Beach, California  
a division of Beckman Instruments, Inc.  
Engineering representatives in principal cities

# MICRO-BEARING ABSTRACTS

by A. N. DANIELS, President  
New Hampshire Ball Bearings, Inc.



stat incorporating the features mentioned above is shown in Fig. 3. Basically, the rheostat consists of a resistance element, a collector bar, and a wiper arm. The metal film resistance element was fabricated by sputtering a nickel film on a glass base. The collector bar is solid copper.

## DYNAMIC AND STATIC LOAD RATINGS

Load ratings of MICRO bearings are based on standards established by the Anti-Friction Bearing Manufacturers Association and are the result of extensive tests.

The "life" of an individual bearing is defined as the number of revolutions the bearing makes before the first evidence of fatigue develops. Fatigue, in turn, is a function of bearing load and although other factors, such as contamination and high temperature, affect the life of a bearing, it is assumed that clean bearings running at normal temperatures are being considered.

It is not possible to predict the life of any individual bearing. The problem, therefore, is best approached by a consideration of empirically derived dispersion curves which provide a means of determining bearing life on a probability basis. That is, they permit the average life of a given group of bearings to be accurately specified.

For purposes of standardization, the "rating life" of a group of apparently identical ball bearings is defined as the number of revolutions that 90% of the group will complete or exceed before the first evidence of fatigue develops. This figure is approximately one-fifth of the average life.

If two groups of similar bearings are run under different loads  $F_1$  and  $F_2$  within normal operating range of loading and rpm, their lives  $L_1$  and  $L_2$  are inversely proportional to the cubes of the loads, i.e., The BASIC LOAD RATING C is that radial load which a group of apparently identical bearings can endure for a rating life of one million revolutions, with stationary load and rotating inner ring. Within normal operating ranges, rating life for any load is a constant number of revolutions, so the following relationship, a restatement of the inverse cube proportion, may be used to compute rating life when basic load rating and applied radial load are known:

$$L = \left(\frac{C}{P}\right)^3$$

L=rating life in millions of revolutions  
where, C=basic load rating in pounds  
P=applied radial load in pounds

The nomograph illustrated permits the quick evaluation of any one of the three quantities when the other two are known. For example, if the C rating of a given bearing is 95 pounds, and the bearing is loaded radially with

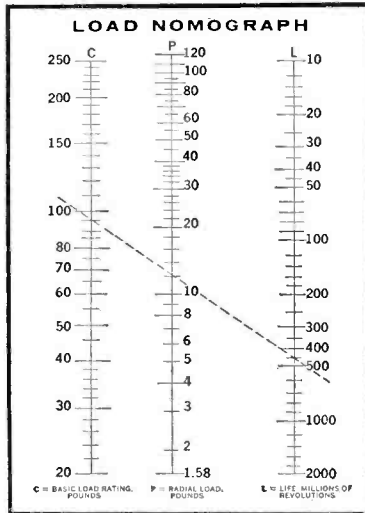

12 pounds, P, a straight edge crossing these two values in their respective columns shows that the bearing could be expected to have a life, L, of 450 million revolutions.

### "EQUIVALENT LOAD"

Bearings whose loads are primarily radial are usually also subjected to axial forces. When the axial component of the load is greater than a negligible value, this combined radial and thrust load may be expressed in terms of a simple radial load in order that the basic load rating C may be calculated. This simple radial load is known as the "equivalent load", which is that constant stationary radial load which, if applied to a rotating inner ring, would give the same life as that which the bearing will attain under the actual conditions of load and rotation.

A formula for determining "equivalent load" and a more comprehensive discussion of static and dynamic loads is found in our design handbook.

### DESIGN HANDBOOK OFFERED FREE

You'll find this new, 70-page authoritative publication a great help in solving problems in designing instruments or small electro-mechanical assemblies.

Write to: New Hampshire Ball Bearings, Inc., Peterborough 1, N.H.

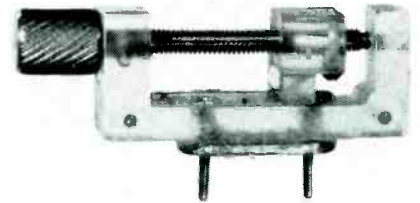
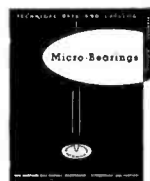

FIG. 3—Experimental vhf rheostat

The resistance element and collector, spaced approximately  $\frac{1}{8}$ -in. apart, are attached to the base of the holder. The wiper arm, made of spring bronze, is attached to the carriage, which is positioned to the desired resistance setting by the leadscrew.

Except for minor difficulties the vhf rheostats have been satisfactory as experimental models. Several units were troublesome because of deterioration of the nickel resistance film, which is sensitive to corrosion. Metals of the platinum family, which are less sensitive to corrosion, have been used as substitutes for nickel. Osmium, a member of this family, is extremely hard and appears to be adherent to glass.

Satisfactory operation has been obtained with several units using osmium. Erratic operation was also caused by the rigidity of the wiper arm and imperfections in the surface of the glass. Improvements have been realized through modification of the wiper arm by slotting each finger. This makes a more flexible unit that follows small imperfections in the surfaces of the resistance and collector elements. Several resistance elements using etched glass as a base for the metal film appeared to give improved operation.

Although the vhf rheostat is com-

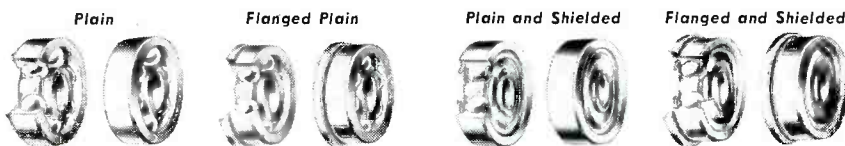

Typical cut-away views of instrument-type retainer ball bearings.

NEW HAMPSHIRE BALL BEARINGS, INC., PETERBOROUGH 1, NEW HAMPSHIRE

District Offices: Pasadena, Calif., Park Ridge, Ill., and Great Neck, N. Y.



**NOW! END READOUT CONFUSION...**  
*with the new KIN TEL digital voltmeter*

**ANOTHER FIRST FROM KIN TEL!** Here is a digital voltmeter that shows numbers on a readable single plane! With KIN TEL's new design, there are no superimposed outlines of numbers in the picture...no confusion caused by dials and old style numerical readouts. This digital readout uses a simple projection system — provides 7,000 to 8,000 hours of lamp life, compared with 100 to 200 hours for ordinary readouts.

**FIRST OF A COMPLETE LINE OF DIGITAL INSTRUMENTS!** Others include: Converters for measuring AC, ohms, ratios...multiple input scanners...serial converters to drive typewriters and punched tape units.

**WIDE APPLICATION!** KIN TEL digital instruments are ideal for automatic check-out systems for missiles and rockets; computer measurements; process control monitoring; production testing; test system calibration; strain gage, thermocouple and other transducer measurements, and calibration of laboratory and industrial electronic instruments.

Talk to your local KIN TEL representative. Sales and service everywhere. Or write us direct for further information.

*See the difference!*



ORDINARY READOUT



KIN TEL READOUT

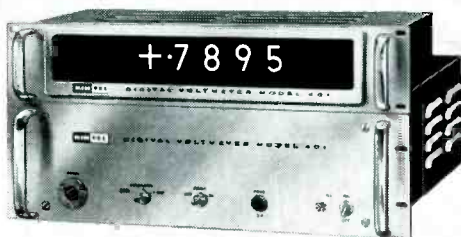

CLEAR AND SHARP, ANY WAY YOU LOOK AT IT

- 100 Microvolt Sensitivity
- Automatic, Continuous Standard Cell Calibration
- High Reliability
- 0.0001 to 999.9V—Plus Automatic Decimal and Polarity Indication

**SPECIFICATIONS**

**Display...**Four (4) digit with automatic polarity indication and decimal placement. Total display area 2" high x 7.5" long, internally illuminated. Individual digits 1.25" high.

**Automatic Ranges...**0.0001 to 999.9 volts covered in four ranges.

**Accuracy...**0.01% or 1 digit, whichever is larger.

**Counting Rate...**30 counts per second, providing average balance (reading) time of 1 second, maximum balance time of less than 2 seconds.

**Reference Voltage...**Chopper-stabilized supply, referenced to an unsaturated mercury-cadmium standard cell.

**Input Impedance...**10 megohms, all ranges.

**Output...**Visual display, plus print control. Automatic print impulse when meter assumes balance. No accessories required to drive parallel input printers.

**Input...**115 volt, 60 cycle, single phase, approximately 75VA.

**Dimensions...**Control unit, 5¼" high x 19" wide x 16" deep. Readout display, 3½" high x 19" wide x 9" deep.

**Weight...**Approximately 40 lb.

**Price...**\$2,100

Over 10,000 KIN TEL instruments in use today!



(KAY LAB)

5725 Kearny Villa Road  
 San Diego 11, California

# stoddart coaxial attenuators and terminators

*made with exclusive  
Stoddart Filmistors  
for highly accurate  
and stable resistive values*

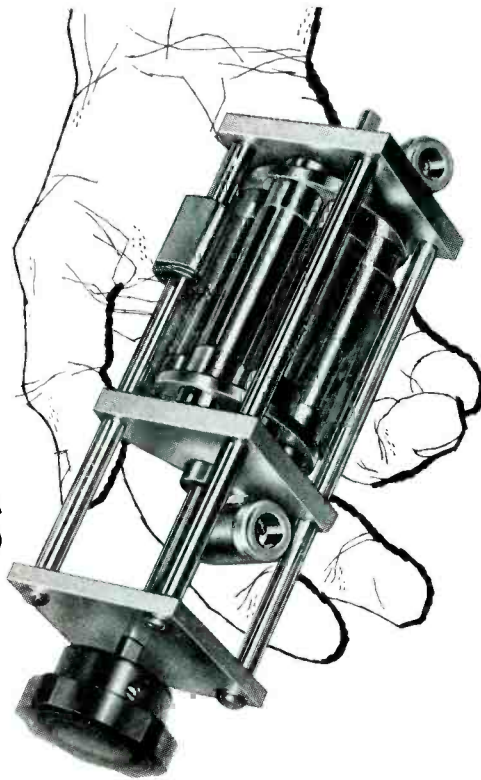

## 6 position TURRET ATTENUATORS with simple "pull-turn-push" operation

Extremely precise resistance values from dc to 3000 mc are maintained by Stoddart-developed Filmistors—thin metallic films in ceramic forms which are assembled in properly designed coaxial sections. Turret units are small, and built for long service.

VSWR: Better than 1.2 to 3000 mc.  
Characteristic Impedance: 50 ohms  
Attenuation Value: Any value from 0 db to 60 db  
Accuracy:  $\pm 0.5$  db  
Power Rating: 1.0 watt sine wave  
Connectors: Type N, female

### ATTENUATOR PADS

*Uniform size, many combinations*



You can specify these small "in-the-line" pads in any conceivable combination of male and female Type C and Type N connectors. Single pads with female connectors can be provided with flange for panel mounting. Convenient to use... pads have maximum length of only 3" for any attenuation value. Electrically, pads are the same as those in turret model above.

### COAXIAL TERMINATIONS

*small, stable—50 or 70 ohm*



**1/2-watt terminations**—50 ohms impedance, TNC or BNC connectors, to 3000 mc. Low cost. VSWR less than 1.20.

**1-watt terminations**—50 ohms, DC to 3000 mc or DC to 7000 mc. VSWR less than 1.20. Type N or Type C connectors, male or female. 70-ohm, Type N, male or female terminations available.

Platinum film resistors, gold-plated electrical contacts, durable satin chrome exterior finish. Wattages are continuous sine wave ratings.

*All items immediately available from stock*

*Send for Attenuator Catalog A-2*

# stoddart aircraft radio co., inc.

6644 Santa Monica Blvd., Hollywood 38, Calif. • Hollywood 4-9294

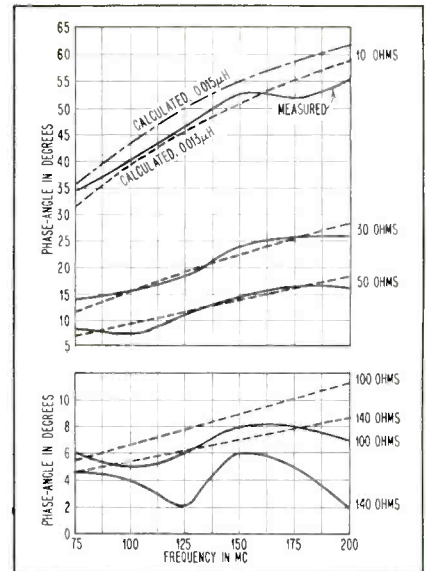

FIG. 4—Measured and calculated phase angles of vhf rheostat

parable to fixed resistors, resistance values below approximately 100 ohms require some form of reactance compensation to reduce the phase-angle to less than 11 deg for CI meter applications.

From data collected it seems reasonable to assume that, for low resistance values, the rheostat may be equivalent to a variable resistance in series with a constant inductance. Figure 4 compares measured and calculated values. A value of 0.013 microhenrys fits the actual vhf rheostat data very closely. Series compensation of the rheostat was accomplished with fixed capacitors.

Since the vhf rheostat may be used in circuits in which both terminals are above ground, it is appropriate to determine some indication as to the magnitude of the distributed capacitance existing between the rheostat and the ground plans upon which it may be

Table I—T-Network Equivalent Distributed Capacitance Rheostat and Ground

Fre- quency in mc	R = 100 ohms R = 60 ohms	
	Com- pensated C = 500 $\mu$ f	Com- pensated C = 91 $\mu$ f
75	2.66	2.85
100	2.45	2.56
125	2.44	2.83
150	2.62	2.77
175	2.63	2.88
200	2.83	2.98

## **Amperex®**

6960 and 6961

**HEAVY-DUTY RF AMPLIFIER  
AND OSCILLATOR TRIODES  
6 kw plate dissipation**

Developed specifically for use in industrial RF generators, as well as communications transmitters. Exclusive Amperex "K" grid reduces primary and secondary grid emission, permits exceptionally high grid dissipation ratings and results in higher plate power output with intermittent industrial loads in Class C operation. Maximum ratings apply up to 30 Mc. Type 6960 is water-cooled; Type 6961 is forced-air cooled.



***whether you require high power reserve***

*for heavy-duty industrial RF generators*

## **Amperex® 7004**

**COMPACT COAXIAL UHF  
TRANSMITTING TRIODE**

300 watts maximum plate dissipation

Developed for UHF oscillator, amplifier and frequency multiplier service. Unique, space-saving design; external anode; forced-air cooling; integral radiator. Maximum ratings apply up to 900 Mc. Available in glass or ceramic versions.



***or outstanding HF performance***

*up to 900 megacycles for compact communications transmitters*

***ask Amperex***

*about tubes, data and applications engineering assistance.*



address all correspondence to:

Communications and Industrial Tube Division, Amperex Electronic Corp., 230 Duffy Avenue, Hicksville, L. I., N. Y.

In Canada: Rogers Electronic Tubes & Components, 11-19 Brentcliffe Road, Leaside Toronto 17.

*translate flow*  
*... into pounds per hour*  
**at a glance!**

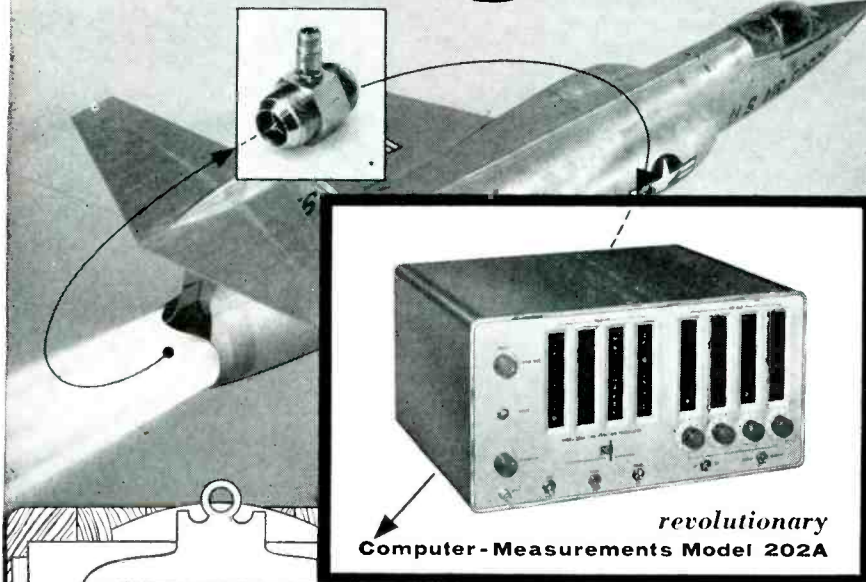

*revolutionary*  
**Computer-Measurements Model 20A**

## TIME-FUNCTION TRANSLATOR

### Applications:

- ✓ Gallons per minute . . .  
into Gallons per hour
- ✓ Gallons per minute . . .  
into Pounds per hour
- ✓ Pulses per second . . .  
into Gallons per minute
- ✓ Total Count of Gallons or Pounds
- ✓ Tachometer Applications
- ✓ Direct Frequency Measurement
- ✓ Many Others

Translating flow into weight as required for jet engine analysis is just one of the many uses for the all-new Model 20A TIME-FUNCTION TRANSLATOR. The 20A permits instant direct read-out of unknown quantities by translating one function of time into another function of time. It eliminates the need for conversion tables, graphs, charts, etc. The variable time base display may be illuminated or blanked at operator option. The versatile 20A fills a long recognized need in electronic measurement.

*Write for complete information  
and detailed specifications on  
the Model 20A Time-Function  
Translator TODAY...*

### SPECIFICATIONS:

Frequency Range:	1-100,000 cycles per second 0-100,000 positive pulses per second
Input Sensitivity:	0.05 volt rms: 10-100,000 cps (5 millivolts optional) 0.07 volt rms: 1-10 cps Positive pulse rise time: 1/2 volt or more per sec.
Input Impedance:	0.5 megohm and 50 mmf.
Accuracy:	± 1 count ± stability
Stability:	Short Term: 1 part in 1,000,000 Long Term: 5 parts per million per week
Time Bases:	0.001 to 10 seconds in 1 millisecond steps 0.0001 to 1 second in 0.1 millisecond steps (0.0001 to 10 sec. in 0.1 millisc. steps, 0.001 to 100 sec. in 1 millisc. steps optional)
Read-Out:	Direct. Four digits. (Five digits optional)
Display Time:	Automatic: Continuously variable, 0.1 to 10 sec. Manual: Until reset
Power Requirements:	117 volts ± 10%, 50-60 cycles, 250 watts (50-400 cycles optional)
Dimensions:	17" W x 8 3/4" H x 13 1/2" D
Weight:	35 lbs. net.
Finish:	Panel: Light grey baked enamel Case: Dark grey baked enamel <i>Data Subject to Change Without Notice</i>

\*Model FL Flow Pickup: Courtesy—Wough Engineering Co., Van Nuys, Calif.

**Computer-Measurements Corporation**

5528 Vineland Avenue, North Hollywood, Calif. Dept. 78-P

mounted. Measurements and subsequent calculations of this capacitance were performed on several of the compensated rheostats with various resistance settings and over the frequency range of 75 to 200 mc. Representative results of these measurements are shown in Table I.

In general, the phase-angles of all the open-circuit measurements were close to 90 deg. Therefore, except for extremely high frequencies, the reactance of  $C$  is very large when compared to  $R$ .

The development from which this report was abstracted was supported by the Signal Corps Engineering Laboratories under Contract No. DA-36-039-sc-56730.

## Sweep Testing Thyatron Characteristics

By J. G. WEISSMAN

*Sylvania Electric Products, Inc.  
Kew Gardens, N. Y.*

A CONVENIENT method for determining the firing characteristics of thyratrons is shown in Fig. 1. Direct measurement of thyatron critical grid voltage and indication of surge voltage and peak currents is obtained as well as any anomalies

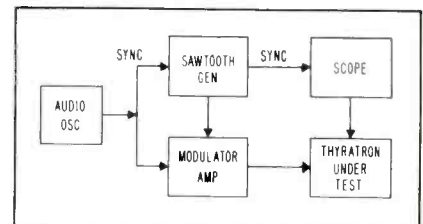

**FIG. 1—Setup for sweep testing thyatron firing characteristics with which critical grid and surge voltages and peak and pre-breakdown currents can be determined**

that may exist, such as pre-breakdown currents.

► **Concept**—The method, in brief, consists of modulating a low-frequency sine-wave carrier with a sawtooth wave. The resulting output wave, shown in Fig. 2, provides sine waves ranging linearly in amplitude from zero to some pre-set

**CMC**



# Waldes Truarc Rings speed assembly, facilitate maintenance, improve performance of new automatic calculator

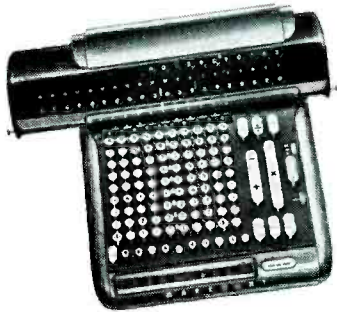

**THE NEW MARCHANT DECI•MAGIC**  
automatic-decimals calculator made by Marchant Calculators, Inc., Oakland, California.

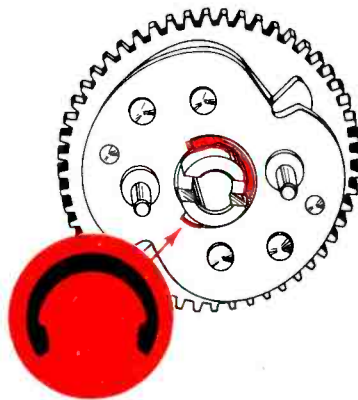

## CRESCENT RING SPEEDS ASSEMBLY, DISASSEMBLY

Main clutch utilizes radially-installed series 5103 crescent ring for rapid assembly and disassembly. Ring's low protruding shoulder provides necessary clearance between ring and the two studs. The main clutch operates each time a Deci-Magic control key is depressed.

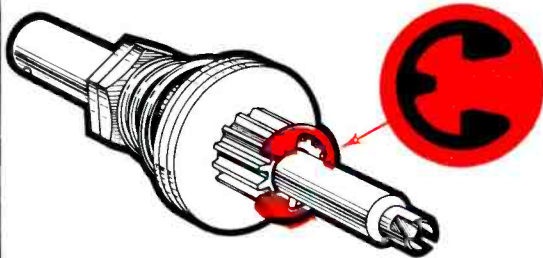

**E-RING SECURES PARTS AGAINST SPRING THRUST.** Slip clutch assembly uses Truarc series 5133 E-ring to hold parts on shaft. Functioning of the assembly is dependent upon the ring's ability to withstand thrust exerted by the heavy barrel spring.

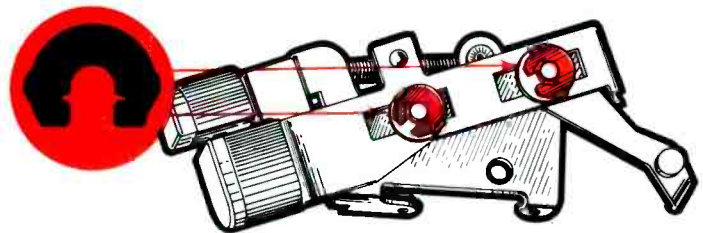

**LOCKING PRONG RINGS PERMIT SIMPLE DESIGN.** Shift slide assembly uses two Truarc series 5139 bowed locking prong rings to lock the parts together in a sliding fit. Precise amount of spring tension prevents objectionable wobble and noise, permits the key to slide smoothly in operation. Easy radial assembly and disassembly of rings facilitates field maintenance and repair. Alternative construction would have required cut washer, spring washer and hairpin-type spring clip on each stud.

Whatever you make, there's a Waldes Truarc Ring designed to save you material, machining and labor costs, and to improve the functioning of your product.

In Truarc, you get

**Complete Selection:** 36 functionally different types. As many as 97 standard sizes within a ring type. 5 metal specifications and 14 different finishes. All types available quickly from leading OEM distributors in 90 stocking points throughout the U.S. and Canada.

**Controlled Quality** from engineering and raw materials through to the finished product. Every step in manufacture watched and checked in Waldes' own modern plant.

**Field Engineering Service:** More than 30 engineering-minded factory representatives and 700 field men are at your call.

**Design and Engineering Service** not only helps you select the proper type of ring for your purpose, but also helps you use it most efficiently. Send us your blueprints today...let our Truarc engineers help you solve design, assembly and production problems...without obligation.

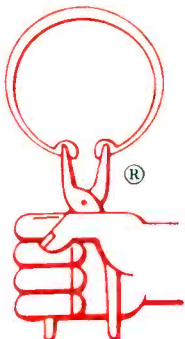

**WALDES**  
**TRUARC**<sup>®</sup>  
**RETAINING RINGS**

WALDES KOHINOOR, INC.  
47-16 AUSTEL PLACE, L. I. C. 1, N. Y.

Waldes Kohinoor, Inc., 47-16 Austel Place, L. I. C. 1, N. Y.  
Please send new, descriptive catalog showing all types of Truarc rings and representative case history applications. (Please print)

Name .....

Title .....

Company .....

Business Address .....

City ..... Zone ..... State .....

E 129

WALDES TRUARC Retaining Rings, Grooving Tools, Pliers, Applicators and Dispensers are protected by one or more of the following U. S. Patents: 2,382,948; 2,411,426; 2,411,761; 2,416,852; 2,420,921; 2,428,341; 2,439,785; 2,441,846; 2,455,165; 2,483,379; 2,483,380; 2,483,383; 2,487,802; 2,487,803; 2,491,306; 2,491,310; 2,509,081; 2,544,631; 2,546,616; 2,547,263; 2,558,704; 2,574,034; 2,577,319; 2,595,787, and other U. S. Patents pending. Equal patent protection established in foreign countries.

# NOW!

• **SAVE**  
• **WEIGHT,**  
• **SPACE**  
• **and**  
• **COST**

**in computing and control systems**

## GAMEWELL Sinusoidal Precision Potentiometers

A specially designed oblong resistance element rotating under 4 wipers generates precision sine and cosine voltages, proportional to the sine or cosine of the shaft rotation angle. Functions produced to an inherent accuracy and smoothness unobtainable by other resistive methods. Can replace eccentric gears, cams and complicated mechanisms in computing, analyzing, navigational and control systems.

**Send for technical data!** Functional detail, dimensions and specifications will help you apply.

### Sketch of Gamewell Sine-Cosine Precision Potentiometer Design

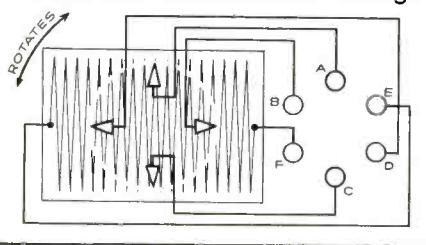

Can be used as a 1 brush device, 2 brush (sine) and 2 brush (cosine) device, or in combinations — to produce various sinusoidal variations. E-F =  $V_{in}$ , A-C & B-D =  $V_o$ .



RVG-17XS  
1 1/16" diameter



RL-11C\*  
2 5/16" diameter

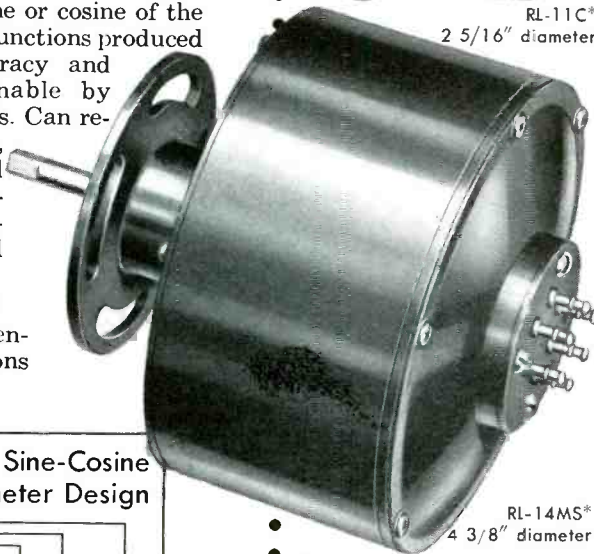

RL-14MS\*  
4 3/8" diameter

\*Described in full in Radiation Laboratory Handbook, Vol. 17.

**THE GAMEWELL COMPANY**  
Newton Upper Falls 64, Mass.



**PRECISION POTENTIOMETER DIVISION**

peak value. This signal, when applied to the grid of a thyratron already biased back to prevent self-firing, will cause the tube to fire when the net value of the negative d-c bias and the positive-going peak of the applied carrier is equal to the strike voltage of that particular tube. By observing the plate wave-

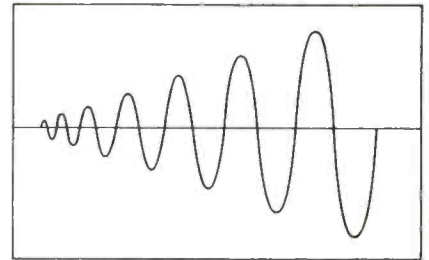

FIG. 2—Triggering waveform applied to thyratron under test

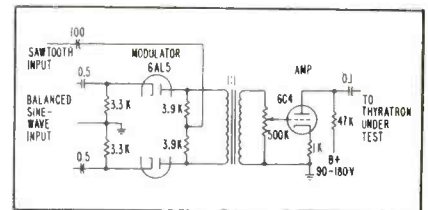

FIG. 3—Modulator-amplifier circuit. Modulates low-frequency sine-wave carrier with sawtooth wave to produce the triggering waveform shown in Fig. 2

forms on an oscilloscope whose horizontal sweep has been calibrated in terms of net grid voltage, the grid firing voltage can be read directly.

► **Circuits**—A balanced carrier frequency, as provided by the audio oscillator, is fed into a 6AL5 balanced diode modulator and 6C4 amplifier shown in Fig. 3. A sawtooth voltage source providing approximately 5-v. peak output will be sufficient for most modulation requirements. Some crossover distortion about the zero axis may be evident but this will not affect accuracy of the system.

The choice of carrier frequency is governed primarily by the ionization and deionization times of the particular thyratron. Frequencies lower than 500 cps are suitable for most thyratrons. A 400-cps carrier modulated by an 8-cps sawtooth is a convenient combination providing 50 positive-going peaks per sweep period. If this sweep is spread over the 10-centimeter use-

## Thermo-compression bonding—

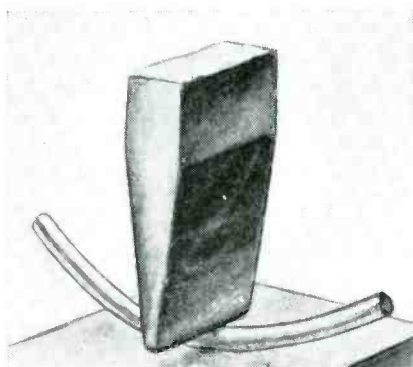

One method of thermo-compression bonding. A heated wedge presses a wire against a heated semiconductor with enough force to deform the wire. Adhesion occurs in seconds.

Thermo-compression bonding provides a new way to attach a wire to a semiconductor. It calls for heat and pressure—nothing else. The wire and the semiconductor are moderately heated, then pressed together under moderate pressure. The resulting bond is very strong—stronger actually than the wire. No chemical flux or molten metal is required.

Eliminating molten metal provides an enormous advantage in fixing electrical connections to transistors. That's because molten metal tends to spatter and spread uncontrollably over the surface of

a semiconductor. And it may alloy with the semiconductor to alter its all-important crystalline structure and chemical purity. Thermo-compression bonding easily and quickly makes a strong permanent electrical connection without damaging the semiconductor. Furthermore, the lead may be attached to microscopic areas and precisely positioned, a most valuable aid in the construction of high-frequency transistors.

Thermo-compression bonding will speed the production of transistors . . . the transistors needed to fill all the new jobs Bell Lab-

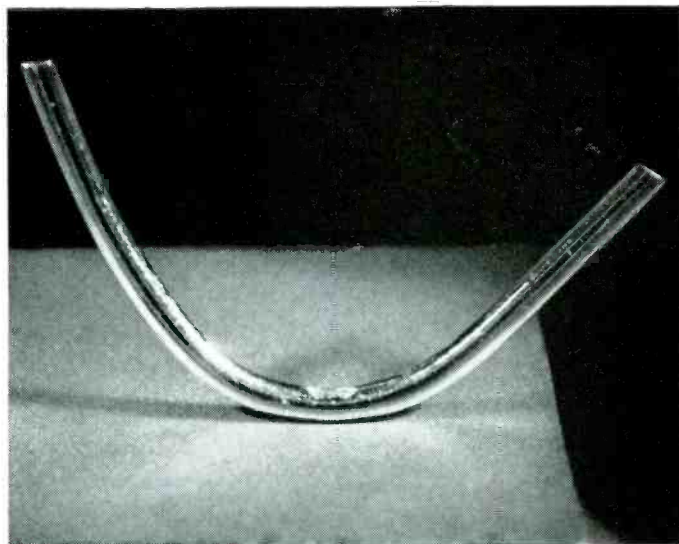

Wire bonded to germanium by thermo-compression technique (enlarged). Wires only 1/10 the breadth of a human hair have been successfully anchored to germanium wafers only three hairs thick. The bond may be an ohmic contact or rectifying contact by adding suitable impurities to the wire and the semiconductor.

## new way to join metal to semiconductors

oratories finds for them in the quest to provide still better telephone service to our growing country.



At Bell Labs Howard Christensen and Orson Anderson discuss their discovery of new bonding principle with Peter Andreatch, Jr., who collaborated in the studies.

**BELL TELEPHONE LABORATORIES**

WORLD CENTER OF COMMUNICATIONS RESEARCH AND DEVELOPMENT



# Electro-Pulse presents

## the 5100 SERIES PULSE CODE GENERATORS and Magnetic Core Testing Equipment

HIGH CURRENT ...

MEGACYCLE OPERATION

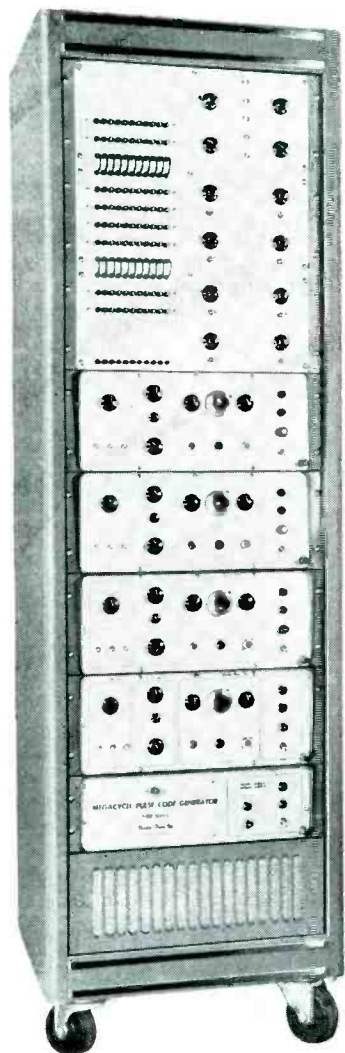

- Ten-Interval Pulse Code
- Five-Interval Controllable Repeat
- Variable Width and Delay Pulses
- Amplitude Variable to 5 Amp. per Channel—500 Mil. Avg. Current
- Independently Coded Channels
- Mixed Output—4 Channels Pos. and Neg.

**Model 5100A**  
Four-Channel Pulse Code Generator

Designed for: Magnetic Memory Core Testing — Switch Core Testing — Magnetic Material Pulse Response Studies — Pulse Code Transmission System Design and Test — Multi-pulse Circuit Development.

The Electro-Pulse 5100 Series Pulse Code Generator has been developed to meet an increasing demand for higher clock rates and higher output currents necessary in data handling and related fields.

The flexible coding system is based on 10 intervals with controllable repeat of five intervals. Each channel Control Unit optionally selects (independently for each interval) a pulse or no pulse.

Four direct channels and two delayed channels feed four output amplifiers to form any required positive or negative code patterns, pulse current amplitudes, or waveforms with variable rise times.

Write for Complete Data: our Bulletin 5100A/E

**Model 3450B**  
MEGACYCLE PULSE GENERATOR

- 2 mc to 200 cps
- Continuously variable pulse width and delay to 100  $\mu$ s in 3 ranges
- Simultaneous pos. & neg pulses

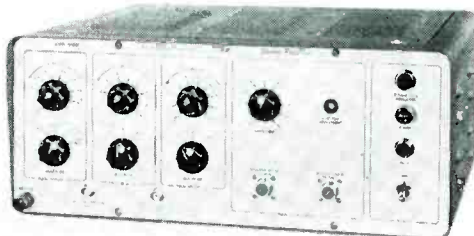

The 5100A Series and the Model 3450B are latest additions to the Electro-Pulse instrumentation line. Others: Precision Pulse Generators, Variable Pulse Generators, Time Delay Generators, Pulse Oscillators, Voltage and Current Calibrators, and Electronic Counters.

Representatives in Major Cities

**EP** Electro-Pulse, Inc.

11861 TEALE ST., CULVER CITY, CALIF. • Phone: EXmont 8-6764 or TEXas 0-8006

ful face length of a standard 5-inch oscilloscope, calibration is simplified.

A typical thyatron test circuit is shown in Fig. 4. The circuit constants shown would be applicable for testing a Type 5643 tube. The externally applied grid bias of  $-5$  volts is sufficient to prevent the tube from self-firing with the 1-megohm grid resistor. The high value of plate load resistor is required to extinguish the tube once it has fired. The exact value of this plate-dropping resistor will depend on the plate supply voltage being used.

A convenient oscilloscope calibration is shown in Fig. 5A. Here the maximum peak-to-peak value of the input signal from the modulator-amplifier has been set to 10 volts, ( $5$ -v positive and  $5$ -v negative about

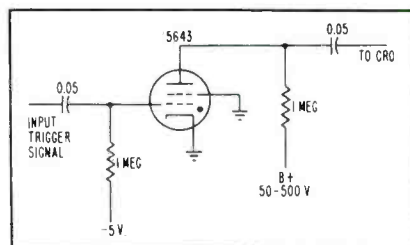

**FIG. 4**—Typical thyatron test circuit for type 5643 subminiature thyatron

the zero axis). Thus, the positive-going peaks of the sine-wave carrier will vary from 0 to  $+5$  volts during each sweep of the modulating sawtooth wave. The actual voltage appearing at the grid of the tube at any instant will be the sum of the externally applied  $-5$  volts d-c bias and the value of the positive-going peak of the carrier at that instant. Thus, the net voltage actually appearing at the control grid will be varying from  $-5$  volts to 0 volts for each sweep period and the time axis of the oscilloscope can be calibrated in terms of net grid voltage.

When this net value of grid voltage reaches the strike voltage of the tube, for example,  $-2.2$  volts, the tube will fire and draw plate current. Plate voltage will then drop, because of the high value of plate load resistor, causing the tube to extinguish. The next positive-going peak of the applied input sig-

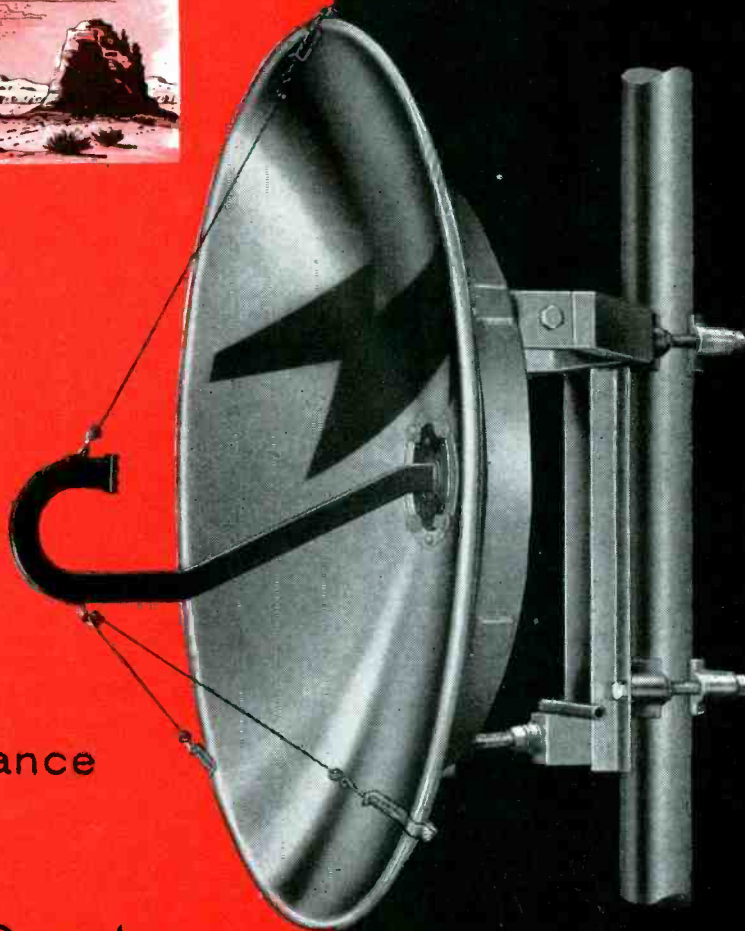
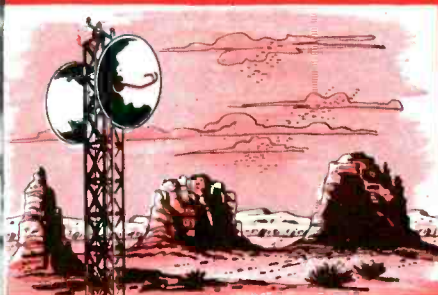
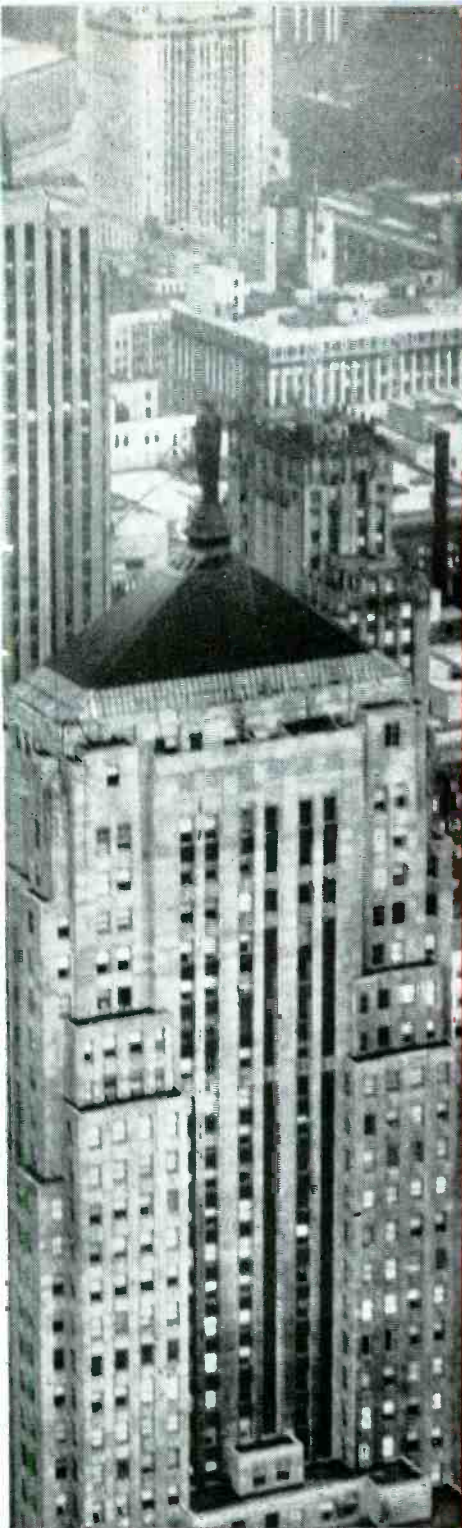

Proved  
Performance  
for  
Cross Country  
Microwave



PARABOLIC  
ANTENNAS

This busy metropolitan area is the termination of over 1000 miles of microwave systems, providing reliable communications across town and country for the Western Union Telegraph Company. ANDREW's experience in research, development and manufacturing is the reason why the dependable performance of an ANDREW PS8-37, eight-foot Parabolic antenna was selected for this installation.

All ANDREW parabolic antennas conform to the newly proposed RETMA-FCC standards governing radiation patterns and side lobes, and they are *guaranteed* to give specified pattern and VSWR in your microwave system.

From a selection of over thirty stocked parabolic antennas, you can choose the type and size that will give optimum system performance with

absolute mechanical and electrical reliability.

Microwave engineers have found ANDREW a valuable partner in planning their communication systems. A parabolic antenna computer for calculating system performance is available to you upon request. Write today for information and expert advice relative to your microwave antenna system requirements.

*Andrew*

CORPORATION 363 EAST 75TH STREET • CHICAGO 19

ANTENNAS • ANTENNA SYSTEMS  
TRANSMISSION LINES

OFFICES: NEW YORK • BOSTON • LOS ANGELES • TORONTO

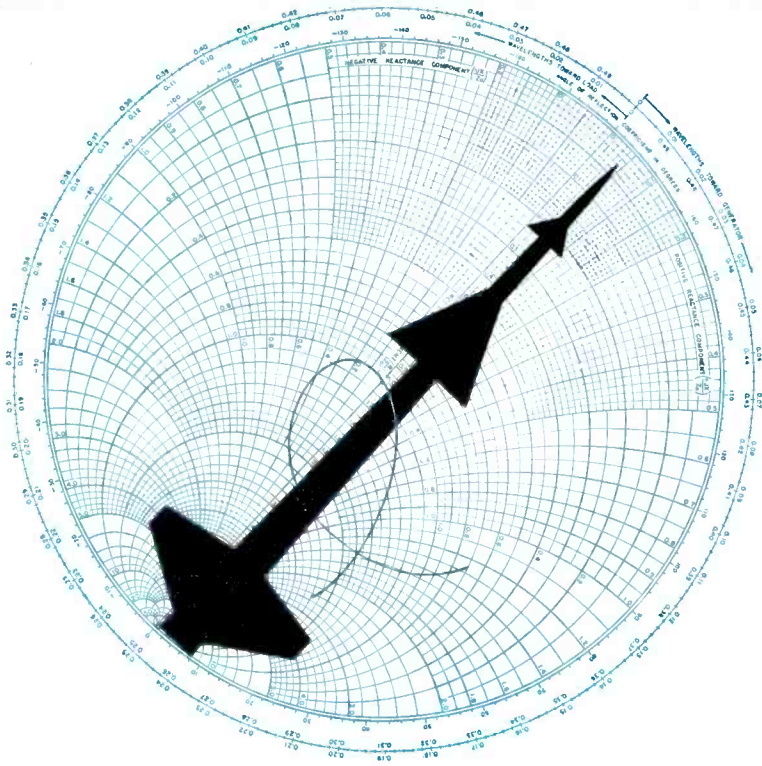

## WRAP IT UP

### WITH TRANSCO ANTENNAS

TRANSCO offers a single, competent source for all—or any part of your antenna program

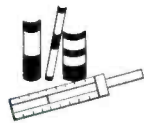

Here is a technical staff and producing facilities. Here, too, are 10 years' experience in supplying a wide variety of approved antennas. We can serve you in Design, Development, Production Engineering and Manufacturing—all, or any combination.

**STUDY AND DESIGN.** We have experienced engineers who draw on broad knowledge. Their designs reflect a firm grasp of practical applications.

**DEVELOPMENT.** Once a satisfactory approach has been chosen, a test sample is "wrung out" in TRANSCO's radiation lab, RF lab and environmental lab.

**PRODUCTION ENGINEERING**—often the missing link—eliminates production delays. We're after design producibility, with a staff of liaison people that keeps design and production on the same track.

**PRODUCTION.** TRANSCO has the capability to support your own requirements. We maintain the highest standards of quality.

*Transco is an active contributor to the ICBM and IRBM programs.*

## TRANSCO PRODUCTS, INC.

*the finest in RF system components*

12210 NEBRASKA AVENUE, LOS ANGELES 25, CALIFORNIA

REPRESENTATIVES IN MAJOR AREAS

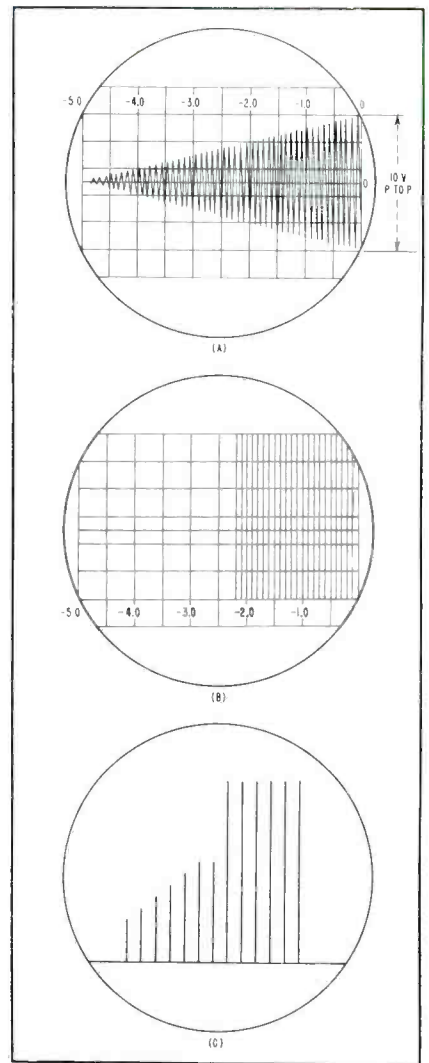
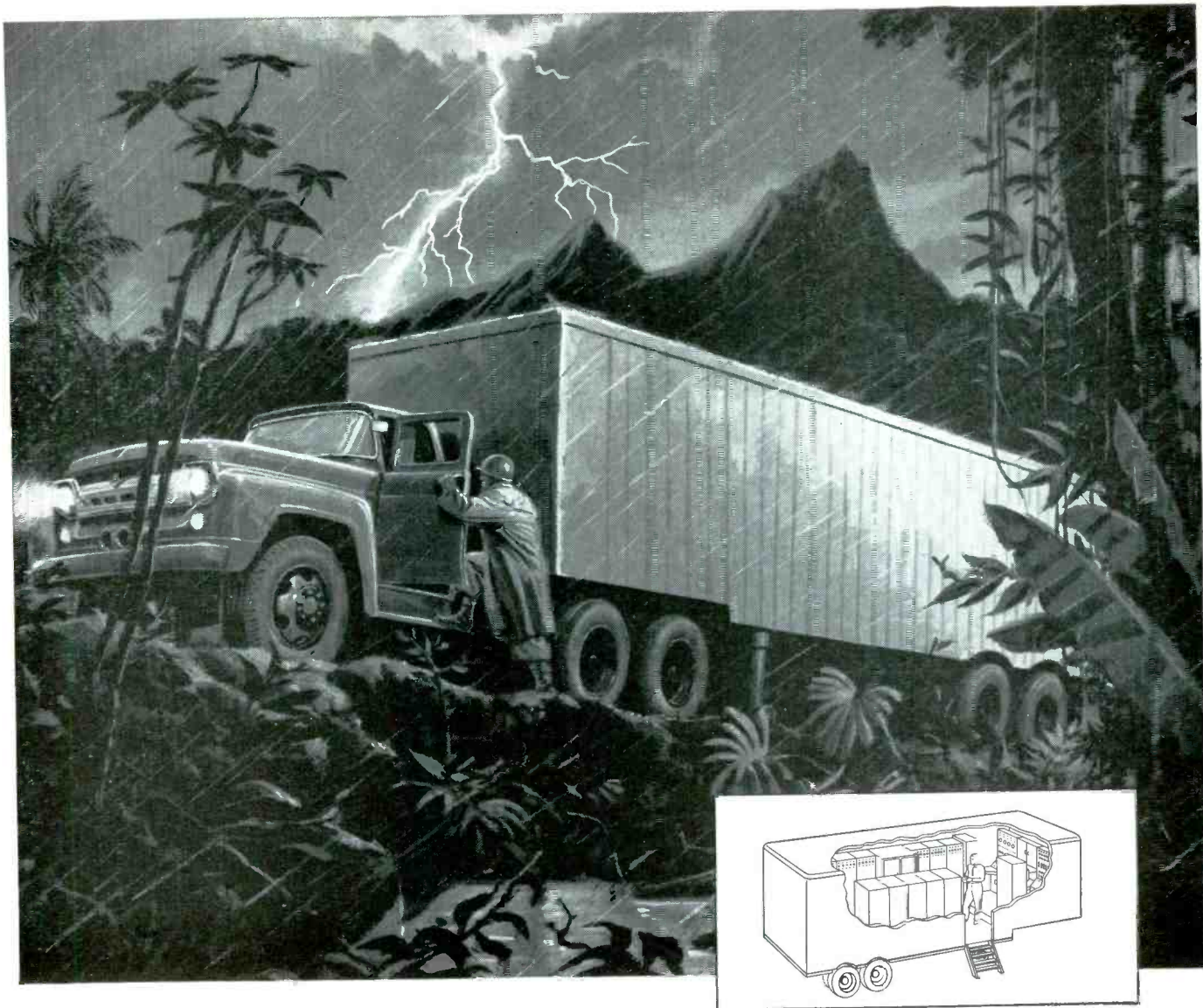

FIG. 5—Waveshapes obtained on oscilloscope during sweep testing of thyratron characteristics. Scope is shown calibrated for measuring strike voltage when input triggering signal (A) to the thyratron is set at 10 volts, peak-to-peak. Strike voltage (B) is  $-2.2$  v. Pre-breakdown currents, indicating incomplete firing (C) can also be determined

nal will again cause the tube to fire and then extinguish. The plate waveform will appear as shown in Fig. 5B. Since the horizontal sweep of the oscilloscope is still calibrated in terms of net grid voltage, the position of the first plate voltage pulse indicates the strike voltage of the particular tube.

From the amplitude of the plate pulse such quantities as surge voltage and peak currents can be determined. The existence of appreciable pre-breakdown currents indicating incomplete firing will be evident if a display such as shown in Fig. 5C is obtained.



## Rugged and right—a computer on wheels **MOBIDIC'S** getting ready to roll anywhere

Today's demands for fast handling of information and split-second decisions have made computers an integral part of many fixed-based operations. BUT why not provide these same advantages to army headquarters *in the field*—where speed is more important than ever before?

This is the problem the U. S. Army Signal Engineering Laboratories and Sylvania are solving together by the development of MOBIDIC—a general purpose mobile digital computer designed to handle the Army's data processing problems in the field and ruggedized to travel over the roughest terrain through the

most difficult temperature extremes.

Mounted in a 26-foot trailer, and ready to roll at any time, MOBIDIC will be available wherever decisions are made, to receive and process information from forward and rear locations, to provide up-to-the-second information to administrative and tactical staffs. Hundreds of details such as unit strengths, firepower, supply and vehicle availability, and field intelligence will become readily available to decision-making staff officers through MOBIDIC.

MOBIDIC's list of skills includes processing of logistical and intelligence in-

formation as well as analytical and real-time computation.

MOBIDIC is another example of Sylvania's integrated approach to systems engineering and close cooperation with the Armed Services. From concept to production, Sylvania's engineering talents and manufacturing facilities are ready for any challenge. If your project requires this kind of capability, Sylvania engineers will be glad to discuss it with you. For information on the capabilities of Sylvania's Electronic Systems Division, write for free booklet titled, "*A Digest of Specific Capabilities.*"



# SYLVANIA

SYLVANIA ELECTRIC PRODUCTS INC.  
 Electronic Systems Division  
 100 First Avenue, Waltham, Massachusetts

LIGHTING • RADIO • ELECTRONICS • TELEVISION • METALS & CHEMICALS

## Transparent Polyethylene Bags Protect Printed Circuits

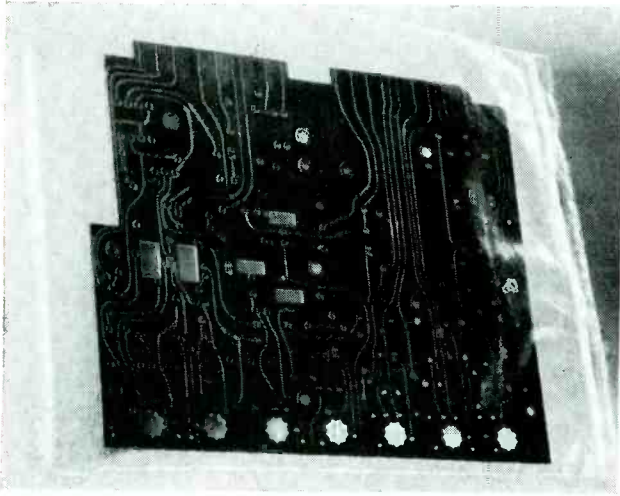

Printed wiring board can be inspected while in bag yet is protected from moisture, dirt and scratches during handling

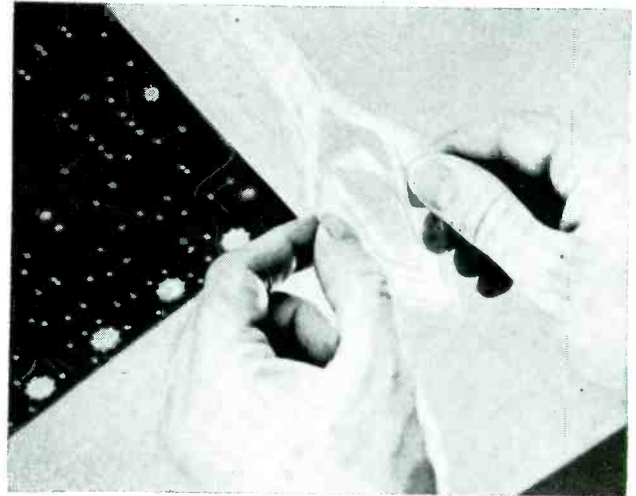

Special pressure-grip closure for bags is sealed by thumb pressure but can easily be opened as shown

TO PROTECT delicate printed circuits used in advanced electronic devices from shipping and handling damage, Photocircuits Corp. is packaging them in specially designed film bags made of Bakelite polyethylene. The polyethylene film bags, which are furnished with a

special dustproof and waterproof pressure closure, protect the parts from scarring during stacking and shipment yet permit visual inspection. They also keep out moisture and dirt during storage.

Standard bag sizes as made by Kennedy Car Liner and Bag Com-

pany, Inc., Shelbyville, Ind. are 3 by 6 inches and 8 by 11 inches, using 0.004 inch film. The special closure (supplied by Flexgrip, Inc.) seals with thumb pressure and can be easily opened when the part is needed. The bags are reusable.

## Lab Benches Have Outlets For Three Power Services

POWER REQUIREMENTS for lab benches are solved at GE's Advanced Electronics Center in

Ithaca, N. Y. by designing each bench as a self-contained and independent unit that can be taken

down, relocated and set up in a minimum of time. Wiring is an integral part of each bench, so mov-

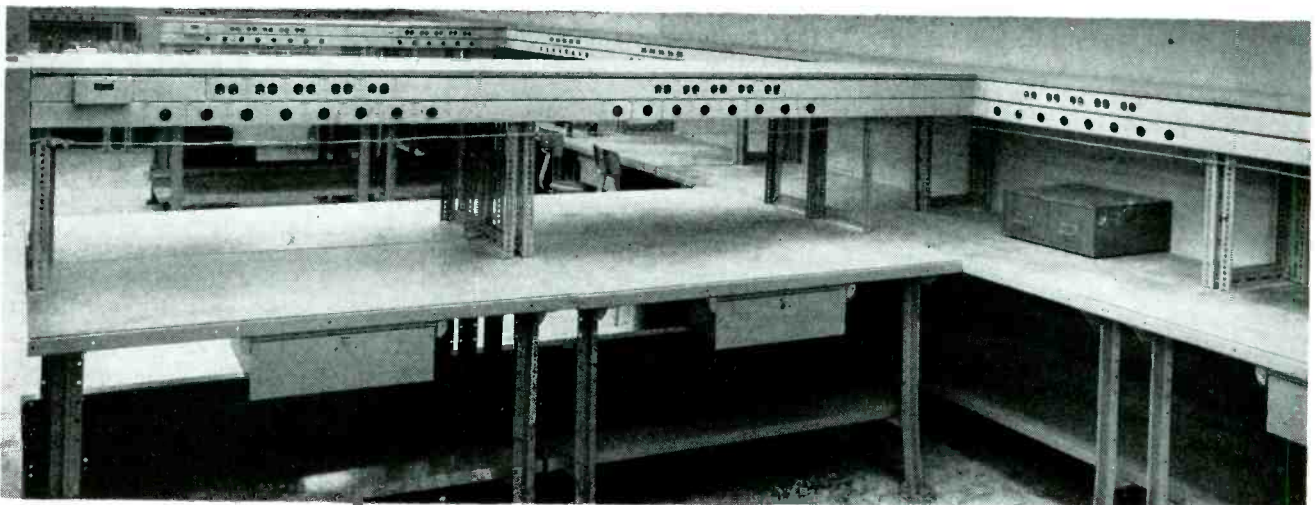

Engineer-designed benches have power outlets arranged in convenient raceways. Square duct at left on bench holds power leads going up to main duct on ceiling





Get More Information ...

Write for your copy  
of the 78-page  
Kester book, "Solder  
... Its Fundamentals  
and Usage." Free!

4.3 lbs - 500 Units

$\$76.57$  Cost  
4.3 lbs

~~22971~~  
~~30628~~  $\$3.30$

~~329251~~

$3.50$   
 $2.83$  (14.24% less)

$3.30$  .47

$\$78.57$   
3.6 lb  
47142  
23571  
282852  $\$2.83$

Just no other way  
to figure it —  
**KESTER SOLDER**  
costs less!  
to use!

# KESTER SOLDER

*Company*

4204 Wrightwood Avenue • Chicago 39, Illinois  
Newark 5, New Jersey • Brantford, Canada

ing merely involves reconnecting to power sources.

Necessary versatility is achieved with multiple runs of Wiremold 3000, a raceway system. The benches have the outlets mounted above the work surface in two runs to provide three standard voltages, with a fourth being added where necessary.

The top run has 115-v single-phase, three-wire service with grounded receptacles, controlled by a 20-amp circuit breaker. The bottom row has 400-cps, three-phase, 220-v service on four-prong receptacles, alternating in the same raceway with 28-v d-c receptacles. Two 30-amp breakers mounted on the end panel of the bench control these two services.

Power is brought from the outside to a power room on each floor. From there it is carried through metal ducts to distribution panels in each laboratory. From the panels, square ducts take it to the benches where it is carried through Wiremold to the outlets. Constancy of power to the center section of each bench is regulated by a Variac. The side sections are on line voltage.

## Ultrasonic Welding Joins Foil to Wires

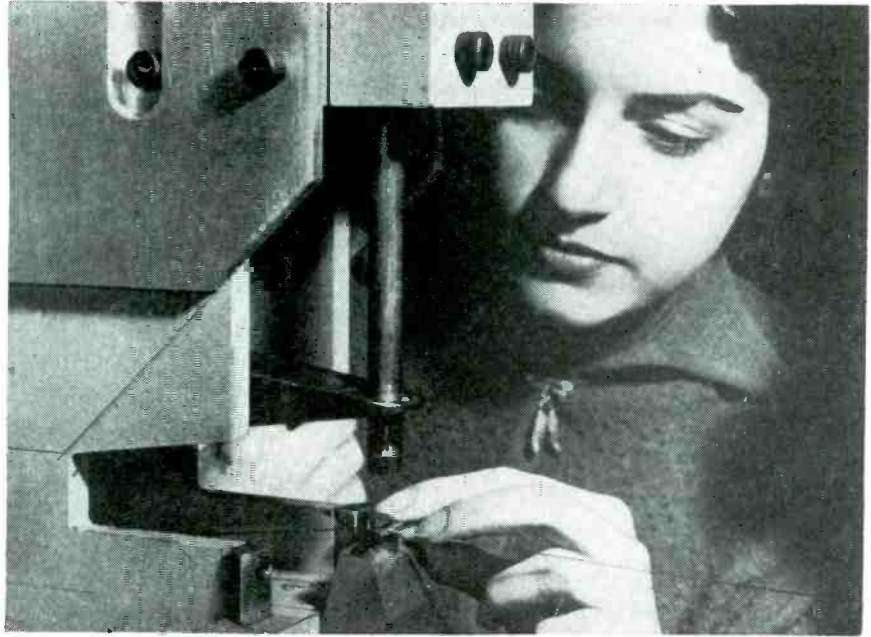

Joining aluminum foil to copper foil with ultrasonic welding unit at General Engineering Labs of American Machine and Foundry Co.

SOLID STATE BONDS with deformations only a fraction of those of pressure welding, usually without heat, can now be achieved reliably with ultrasonic welding. Since there is no current passing through the joint, there is no

arcing, spitting or sputtering. Extremely thin electrical conductors of foil dimensions can be joined to members of similar or much heavier thicknesses, as well as to wire of the same or different composition. In many cases in-

## Design of the Month: CERAMIC VACUUM RELAY

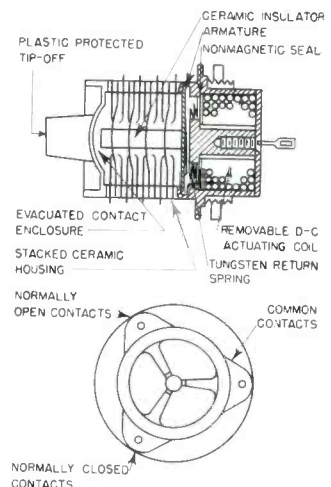
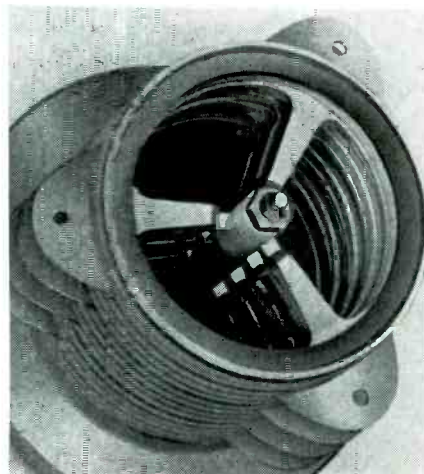

Use of moly sheet stock for contacts and moly-manganese metallizing on unglazed 96 percent alumina permits oven firing of stacked assembly to give vacuum-tight housing for relay. Unit is no larger than hen's egg yet capable of handling 50-ampere motor starting currents. As designed by Jennings Radio Mfg. Corp. of San Jose, Calif., the new miniature relay employs three sets of contacts in parallel to eliminate contact bounce and chatter at vibrations up to 25 G and shocks up to 50 G at temperatures up to 200 C. Moving contacts are in

center of relay, insulated from steel actuating shaft by ceramic bushings. At bottom of shaft is iron armature, actuated through nonmagnetic seal by coil outside vacuum chamber. Coil is anchored by one screw, permitting easy replacement. Inherently clean contact surfaces in high vacuum also provide positive insurance of dry-circuit conductivity, so that contact resistance is low for microampere currents even after years of shelf life as required in stockpile missiles. Plastic cap covers razor-sharp edge of exhaust tip-off

# New Sperry Reflex Oscillator Klystron

IMMEDIATE DELIVERY

# COVERS FULL X BAND

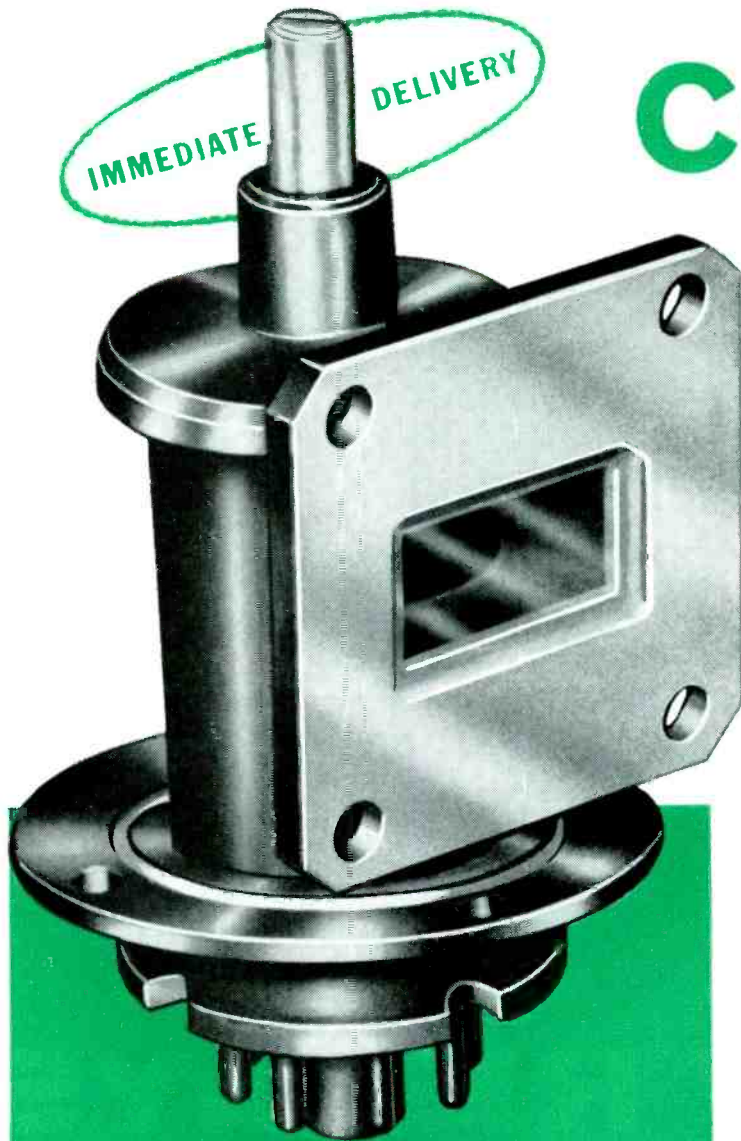

**SRX-92**

Tunes over a 21% band

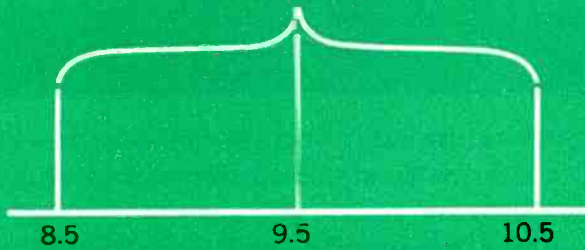

### SRX-92 Specifications

Frequency Range.....	8.5 to 10.5 kmc
Output Power (VSWR 1.1).....	20 mw (min.)
Electronic Tuning Bandwidth.....	35 mc (min.)
Beam Voltage (maximum rating).....	300 v
Reflector Voltage (maximum rating).....	0 to -350 v

Low-Voltage Test Oscillator  
Spans 21% of Center Frequency

Featuring complete coverage of the frequency range from 8.5 to 10.5 kmc, the new SRX-92 reflex oscillator klystron is designed for use as a local oscillator in microwave receivers and spectrum analyzers, as a signal source in radar test equipment, or as a low-power bench oscillator.

Low-voltage operation, low hysteresis and high thermal stability are other important advantages of this new klystron, which delivers a minimum output power of 20 mw over a minimum bandwidth of 35 mc. In addition, it offers single-screw tuning over the entire frequency range, with integral cavity and tuner.

Sperry has packaged all these key features in a klystron that combines low cost and small size—it weighs only 4½ ounces. For detailed information on the SRX-92 and other Sperry klystron tubes, write or phone the nearest Sperry district office.

**ELECTRONIC TUBE DIVISION**  
**SPERRY GYROSCOPE COMPANY**  
Great Neck, New York

DIVISION OF SPERRY RAND CORPORATION

BROOKLYN · CLEVELAND · NEW ORLEANS · LOS ANGELES  
SAN FRANCISCO · SEATTLE · IN CANADA: SPERRY GYROSCOPE  
COMPANY OF CANADA, LTD., MONTREAL, QUEBEC.

**P&B PROGRESS**  
HIGH SHOCK CRYSTAL-CASE RELAYS



# 2 NEW RELAYS

Crystal-Case Size! Permanent Magnet Design.

No Contact Openings. Shock: 100g. Vibration: 30g 55 to 2000 cps.

**SC NON-LATCHING TYPE**—This micro-miniature relay sets new standards—in design, in performance, in reliability. Yet the SC conforms to standard dimensions and circuitry and may be used to replace ordinary crystal-case relays. A permanent magnet in the structure provides *at least twice the contact pressure found in relays of comparable size*. This extra force accounts for the extremely high shock and vibration resistance shown in the specifications.

**SL LATCHING TYPE**—Unique magnetic latch assures positioning of armature and exceptional pressure. A 1 watt, 3 ms. pulse to either coil transfers contacts. Transfer time is only 0.5 ms. Coils are designed for continuous duty. Has the same exceptional shock and vibration characteristics as the SC.

POTTER & BRUMFIELD, INC., PRINCETON, INDIANA/SUBSIDIARY OF AMERICAN MACHINE & FOUNDRY COMPANY

Over 40 P&B Basic Relays  
More than 20,000 Variations



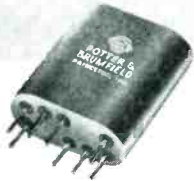
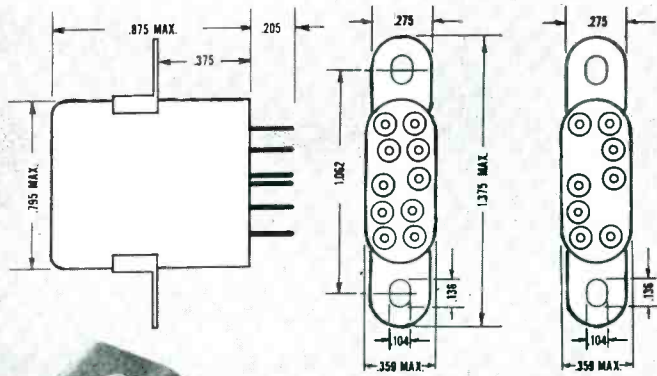

SL—dual coil latching relay. Operates on a 1 watt, 3 ms. pulse at nominal voltage. Permanent magnet latch locks the armature in either position.

SC—non-latching relay with series-connected dual coils. Operates on approximately 1 watt at nominal voltage. Coils must remain energized to hold the armature in the operate position.

### SC and SL Series Engineering Data

**GENERAL:** Insulation Resistance: 10,000 megohms, min.  
 Breakdown Voltage: 1,000 V. RMS.  
 Shock: 100g.  
 Vibration: 30g 55 to 2000 cps.; 0.195" max. excursions from 10-55 cps.  
 Temperature Range: -65° C. to +125° C.  
 Weight: 17.5 grams (5/8 oz.).  
 Operate Time: 3 MS. max. with 550 ohm coil @ 24 V. DC. (SL: 630 ohm coil at 24 V. DC).  
 Transfer Time: 0.5 MS max.  
 Terminals: (1) Plug-in for microminiature receptacle of printed circuit board.  
 (2) Hook end solder for one #20 AWG wire.  
 Enclosure: Hermetically sealed.

**CONTACTS:** Arrangement: 2 Form C.  
 Material: Gold flashed palladium.  
 Load: 2 amps @ 28 V. DC, resistive; 1 amp @ 115 V. AC, resistive.  
 Pressure: SC—13 grams min.; SL—16 grams min.

**COIL:** Power: Approx. 1.0 watt at Nominal Voltage.  
 Resistance: SL—40 to 1400 ohms; SC—35 to 1250 ohms.  
 Duty: Continuous.

**MOUNTINGS:** Bracket, stud and plug-in.

P&B STANDARD RELAYS ARE AVAILABLE AT YOUR LOCAL ELECTRONIC, ELECTRICAL AND REFRIGERATION DISTRIBUTORS

# Potter & Brumfield, inc.

PRINCETON, INDIANA

SUBSIDIARY OF AMERICAN MACHINE & FOUNDRY COMPANY

Manufacturing Divisions also in Franklin, Ky. and Laconia, N.H.

Mail coupon below for further engineering data on P&B's new SC and SL Series relays plus new compact catalog of standard type relays. If you need answers to a specific application problem, write in detail.

Potter & Brumfield, Inc., Princeton, Indiana  
 Attn: T. B. White, Brig. Gen. USMC (Ret.)  
 Special Projects Engineer

Please send me complete data on the new SC and SL Series relays, plus the new compact catalog of P&B standard relays.

Name \_\_\_\_\_  
 Company \_\_\_\_\_ Dept. No. \_\_\_\_\_  
 Address \_\_\_\_\_  
 City \_\_\_\_\_ Zone \_\_\_\_\_ State \_\_\_\_\_

See our catalog in Sweet's Product Design File

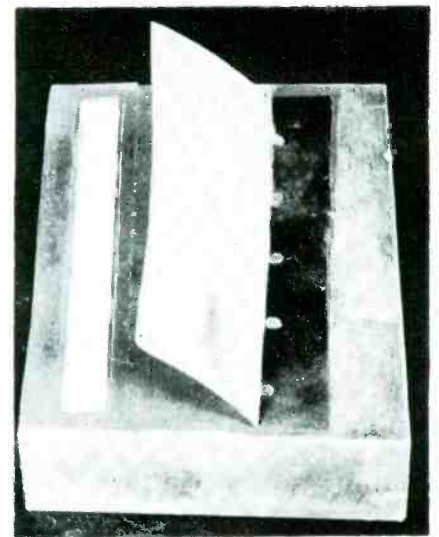

Aluminum foil only 0.001 in. is here ultrasonically welded to 1-in. aluminum plate

sulated sheet or foil can be welded without prestripping. Also, it is of use in joining foil or fine wire of copper or aluminum to wire, sheet, tube or plate material.

► **Welding Foil Coils**—One of the principal factors that has restricted the acceptance of foil for coils is the problem of making sound connection between the aluminum and the copper leads. Aluminum is difficult to solder, and resistance welding will often burn through the foil. Ultrasonic welding is one of the most promising methods here.

Aluminum foil as thin as 0.00015 in. can be welded readily to wire, other foil or other members. Relative thickness of the parts being joined is no problem; 1-mil foil can easily be welded to a 1-inch aluminum plate. The strength of ultrasonic welds in aluminum compares favorably with that of other methods, including high-pressure welding. Ultrasonic welds cause no crystal growth, hence there are no brittle bonds to give early failure from fatigue.

► **Power Needed**—Another desirable feature of ultrasonic welding is the lower power requirement. For example, to join two pieces of 1/8-in. aluminum sheet by resistance welding would require a machine of about 75-kva capacity. An ultrasonic machine using 3 1/2 to 4 kva will do the same job. The

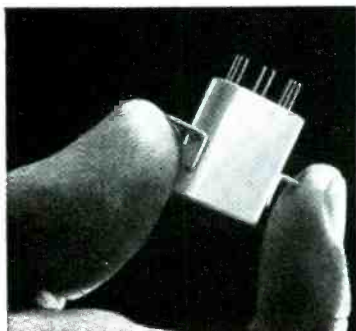

# LEACH

## SOLVES RELAY ENVIRONMENTAL PROBLEMS

Unique Balanced-Armature Relays meet all requirements of the most exacting operating environments — shock, acceleration, vibration and high temperatures.

In the Leach Balanced-Armature Relay, shock and vibration forces cannot move the relay armature. This eliminates faulty operation of contacts during extreme vibration and acceleration.

These Leach Relays meet or exceed requirements of MIL-R-5757, MIL-R-6106, MIL-E-5272. Typical ratings include: vibration, 20 G's to 500 cps (higher ratings available); shock and acceleration, more than 50 G's; temperature,  $-50^{\circ}$  to  $+125^{\circ}$ C; life, 50,000 continuous operations minimum at rated load; available 28 vac, 115 vac, 400 cps operation. At right is Leach 9226, 1.49x1.49x1.68 inches.

Leach has gained a unique reputation for creating reliable relays, *custom-tailored* to solve specific circuitry problems. Write for your copy of the Leach Balanced-Armature Relay Catalog.

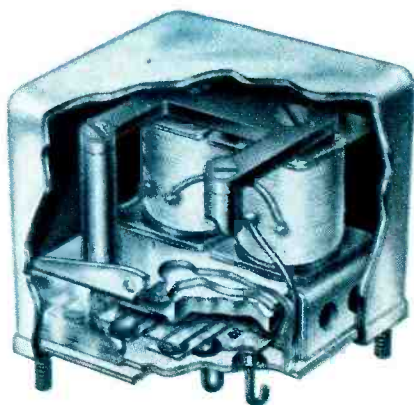

**LEACH** CORPORATION  
LEACH RELAY DIVISION

5915 Avalon Blvd., Los Angeles 3, California

District Offices and Representatives in Principal Cities of U. S. and Canada

latter can be plugged into almost any standard 220-v factory power line and is semiportable. The welding head can be 50 to 100 ft from the electronic apparatus. By contrast, the resistance welder requires special heavy bus bar installation and will be a relatively cumbersome unit to move to a new location.

► **Welding Procedure** — Ultrasonic welds are made by clamping the pieces to be joined with a force of from 10 to 400 lb, and simultaneously introducing vibratory energy at the point of pressure. This high-frequency mechanical energy passes into the metal parts, breaking up the interface between them. In a brief interval, generally under 2 sec, a solid-state metallurgical bond is produced with external deformations that are usually less than 5 percent.

► **Transducer** — The ultrasonic transducer usually consists of a stack of nickel laminations wound with insulated wire. Nickel as supplied by International Nickel Co. gives the largest possible magnetostrictive effect of any commercially available material. Also, it affords a rugged construction that is durable, resistant to elevated temperatures and corrosion, and readily fabricated. Nickel is particularly useful at high power levels.

► **Generators** — Alternating current is supplied to the transducer by a

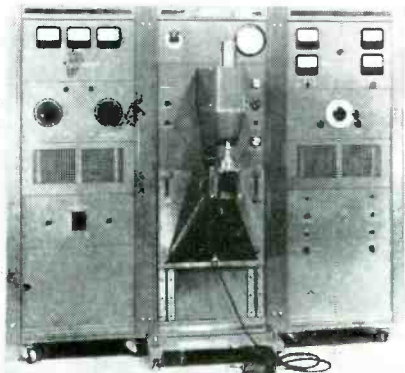

Ultrasonic unit for spot-welding applications, powered by 2,000 r-f watt ultrasonic generator made by Sonobond Corp., West Chester, Pa. Its rugged laminated-nickel-stack transducer will handle aluminum up to 0.050 in. thick

# NO DEPARTURE FACTS

## Get this new Precision Instrument Ball Bearing Catalog today!

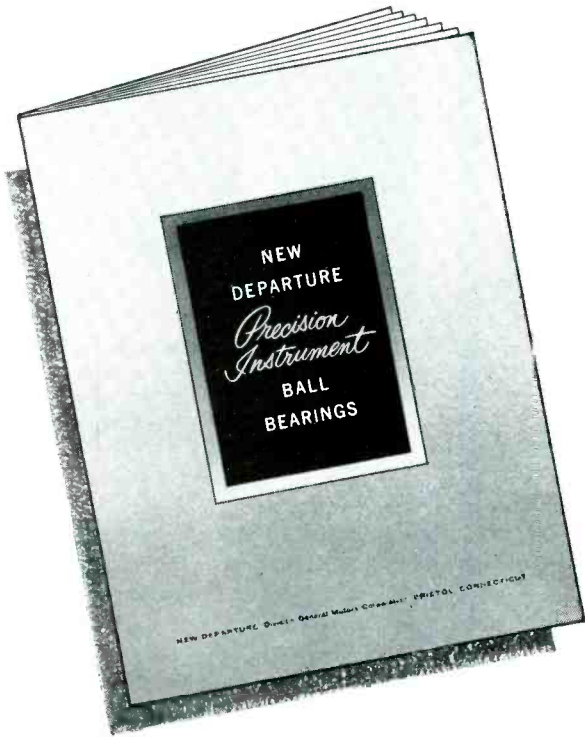

**HERE'S REAL HELP FOR MINIATURIZATION DESIGN PROBLEMS!** You'll find New Departure's latest catalog on precision instrument ball bearings a real friend in need at the design table. It's jam-packed with the kind of data you need to select the *right* ball bearings . . . in either precision instrument or miniature classification.

This new handbook lists sizes and specifications for New Departure's full range of precision instrument ball bearings. In addition, you'll find a wealth of additional helpful information . . . from starting torque limits to bearing lubrication and packaging data.

To add this valuable catalog to your reference library, simply fill out and mail the coupon provided here.



**NEW DEPARTURE**  
DIVISION OF GENERAL MOTORS, BRISTOL, CONN.

NOTHING ROLLS LIKE A BALL

### TABLE OF CONTENTS

- Miniature Series Bearings
- Inch and Metric Series Bearings
- Inch and Metric Series Bearings with Spring Separators
- "H" Series, Non-Separable, Angular Contact Bearings
- "B" Series, Separable, Angular Contact Bearings
- "B" Series Bearings with Removable Shaft
- Bearing Starting Torque Limits
- Radial Play vs. Limiting Static Thrust Load
- Radial Play vs. No-load Contact Angle
- Axial Deflection vs. Thrust Load—Single Bearings
- Axial Deflection vs. Thrust Load—Duplex Bearings
- Duplex Bearing Mounting and Preloading
- Effect of Stickout Tolerances on Bearing Preload Range
- Preload Ranges based on Stickout Tolerances
- Instrument Bearing Tolerances
- Shaft and Housing Fits for Non-Classified Bearings
- Shaft and Housing Fits for Classified Bearings
- Shaft and Housing Shoulders
- Functions of Lubricants
- Oil and Grease Lubrication
- Grease Plating
- Lubricant Storage Life
- Lubrication Selection Guide
- Bearing Limiting Speed
- Aspects of High Temperature Operation
- Bearing Packaging
- Special Bearings
- Instrument Bearing Numbering and Identification
- Miniature Series Bearing Equivalents
- Inch Series Bearing Equivalents
- Inch and Metric Series Equivalents

NEW DEPARTURE, DIVISION OF GENERAL MOTORS  
BRISTOL, CONN.

**PLEASE SEND FREE PRECISION INSTRUMENT BALL BEARING CATALOG.**

NAME \_\_\_\_\_  
POSITION \_\_\_\_\_  
FIRM \_\_\_\_\_  
ADDRESS \_\_\_\_\_  
CITY \_\_\_\_\_ ZONE \_\_\_\_\_ STATE \_\_\_\_\_

# HOMELITE

will meet your specs for  
**LIGHTWEIGHT GENERATORS**

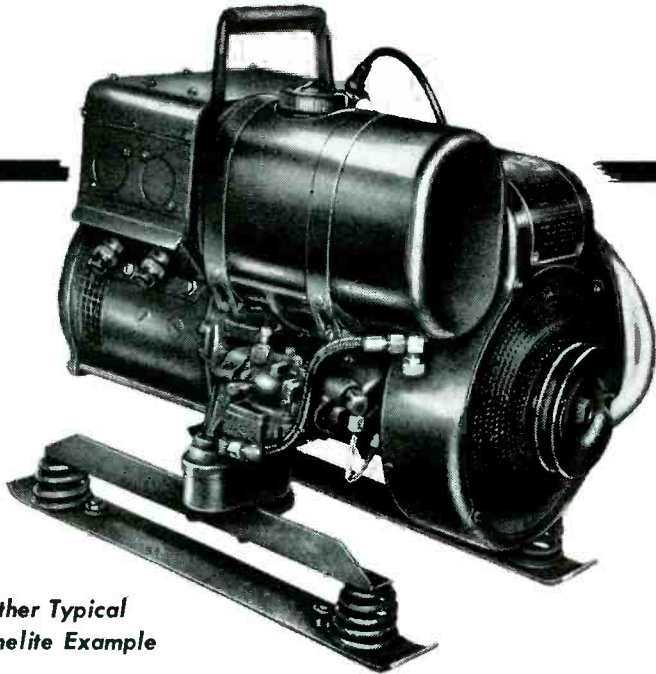

**Another Typical  
Homelite Example**

To meet the requirements for lighter, smaller and more powerful auxiliary gasoline-engine-driven generators for both rotary and fixed wing aircraft, Homelite has designed and built several special units.

Typical of these new Homelite generators is the Model 34D28 shown above.

Weighing only 67 pounds . . . almost half the weight of previous auxiliaries with comparable power . . . this Homelite develops 70 amperes at 28.5 volts DC and is capable of starting 700 h.p. aircraft engines either directly or with a small battery floated on the line.

Requiring less than 3 cubic feet of storage space, this unit is equipped for push button or manual starting and starts without preheating in temperatures as low as minus 40 degrees Fahrenheit.

Meeting specifications for light-weight, powerful generators . . . for both military and commercial applications . . . is the specialty of the house with Homelite. We've been doing it for close to half a century.

No matter how new, how different or how tough your requirements . . .

turn them over to Homelite. The chances are you'll get the most satisfactory answer . . . faster.

Write and our engineers will get in touch with you.

Homelite builds generators in sizes from .15KW up to 5KW in all voltages and frequencies . . . with either gasoline engine or electric motor drive.

Manufacturers of Homelite  
Carryable Pumps  
Generators • Blowers  
Chain Saws

PERFORMANCE • DEPENDABILITY  
SERVICE

## HOMELITE

A DIVISION OF TEXTRON INC.  
6812 RIVERDALE AVENUE  
PORT CHESTER, N. Y.

Canadian Distributors: Terry Machinery Co., Ltd., Toronto, Montreal, Vancouver, Ottawa

power oscillator at the design frequency of the transducer and coupling system. Depending upon the characteristics of the system, this will generally range from 4 to 60

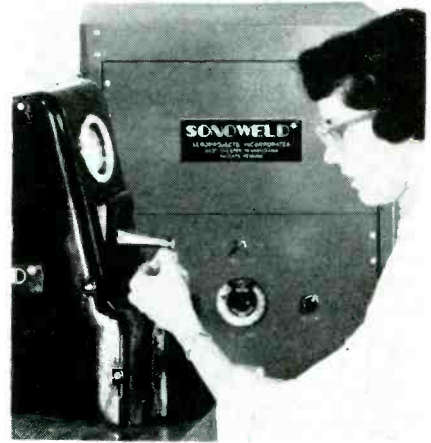

Portable Aeroprojects Sonoweld unit being used for welding thin materials such as foil and fine wire. Power supply at rear is 300 r-f watt ultrasonic generator operating from 117-v a-c line

kc. Units delivering up to 4 kw are in everyday laboratory use and even heavier equipment is in development.

A light-weight and extremely portable ultrasonic welding unit is now available for welding thin materials, such as foil and fine wire. It is powered by a 300-watt ultrasonic generator which operates from a 117-v a-c line and will handle thicknesses up to 0.012 in. of aluminum or up to 0.005 in. of copper.

## Soldering Aluminum Without Fluxing

SIMPLE AND EFFECTIVE techniques for soldering aluminum and its alloys as well as galvanized metals have been developed by G. M. Bouton and P. R. White, metallurgists at Bell Telephone Laboratories. These techniques employ an inexpensive and stable zinc-base alloy as a preferred solder. No flux or vigorous abrasion is necessary. Joints in aluminum made by these methods are stronger than commercial aluminum itself. The tech-



SHIELDING'S *Universal* ENCLOSURE  
PROVIDES MAXIMUM SHIELDING EFFECTIVENESS  
... FOR COMPLYING WITH ALL APPLICABLE  
MILITARY SPECIFICATIONS.

# R. F. *interference* SUPPRESSED

Shielding has the practical solution to all your electro-magnetic suppression problems — the Shielding Universal Enclosure. Multi-Cell® design features either single or double shielding in cell or isolated type enclosure . . . interchangeable standard panels of solid and/or mesh material . . . a wide variety of enclosure sizes both standard and custom-built. A complete test report, performed by independent consulting engineers in accordance with military specifications, has just been completed — evaluating designs and different types of material used. For your copy of this report and the new Shielding folder giving all design details, write today to:



## SHIELDING, INC.

21 READE ST., RIVERTON, N. J.

SALES OFFICES:

CHICAGO — R. EDWARD STEMM  
DENVER — WILLIAMS & ASSOCIATES  
LOS ANGELES — CARL A. STONE ASSOCIATES, INC.  
FORT WORTH — MITCHELL SPEARS COMPANY  
SEATTLE — G. M. GILLETT COMPANY  
CANADA — STARK ELECTRONIC SALES LTD., AJAX, ONTARIO

# NORTH RELAYS

since 1921

prove dependability in  
Westinghouse Visicode  
supervisory control systems

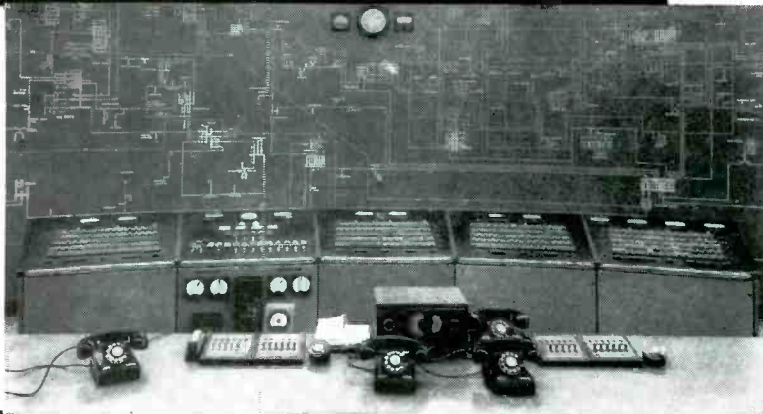

*Dispatching office of the  
Pennsylvania Electric Co.  
at Erie, Pa.*

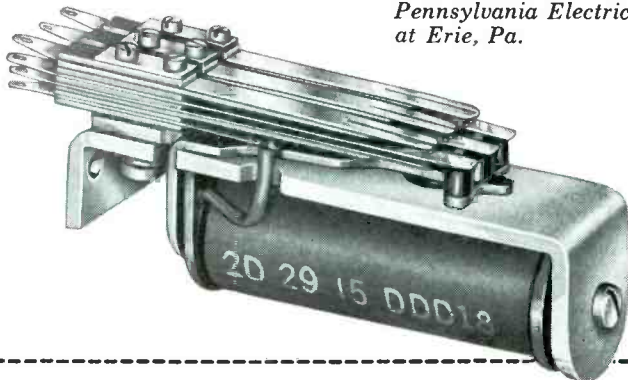

Westinghouse VISICODE supervisory control systems employ "all-relay" terminal equipment developed to provide remote control and supervision of unattended substations of electric utility systems, hydroelectric generating stations, water supply systems, gas and petroleum pipelines and similar applications.

Quoting Westinghouse Descriptive Bulletin 32-450, "Standard telephone-type relays are used because of their extreme simplicity and maximum dependability. The reliability of this relay is demonstrated by the fact that the original installation, made by Westinghouse in 1921 using this relay, is still in continuous service."

The key to any "all-relay" system is the reliability of the basic relay component. For the ultimate in dependability, Westinghouse uses North relays!

YOU, TOO, CAN DEPEND ON

INDUSTRIAL DIVISION

**NORTH ELECTRIC COMPANY**

7712 SOUTH MARKET STREET • GALION, OHIO

Available in Canada through Ericsson Telephone Sales of Canada, Ltd., Montreal 8, P. Q.



After heating uncleaned aluminum with ordinary torch, just a wiping stroke with stick of new zinc-base alloy solder is enough to give perfect tinning



Bright central area is new zinc-base solder (magnified about 15 times) on sheet of commercial-grade aluminum. Around central spot is dark area in which solder has crept under oxide layer and alloyed with aluminum surface

nique is most effective for joints where the surfaces are accessible for manipulation with the solder stick, such as butt and T joints.

Long-term stability of the soldered joint is assured by rigid exclusion of deleterious elements such as lead, tin, bismuth and cadmium from the zinc-base alloy to prevent intergranular corrosion. About 0.05 percent of magnesium may be added to enhance its stability, and from 2 to 8 percent of

# NJE OFFERS

# 10 NEW MODELS OF SOLID STATE POWER SUPPLIES TO MEET THE GROWING DEMAND!

MODEL	OUTPUT		RIPPLE RMS MILLIVOLTS	REGULATION (SEE NOTE 1)	INTERNAL IMPEDANCE DC - 100KC OHMS	PANEL HEIGHT (SEE NOTE 2) INCHES	DELIVERY DAYS	PRICE (INCLUDING METERS)
	VOLTS	AMPS						
SS-7-15	0-7	0-15	1.0	±0.1% or 3 MV	0.005	3½	75	\$ 880
SS-10-10	0-10	0-10	1.0	±0.1% or 5 MV	0.02	3½	75	700
SS-32-3	0-32	0-3	1.0	±0.1% or 10 MV	0.10	5¼	45	600
SS-32-10	0-32	0-10	1.0	±0.1% or 10 MV	0.04	8¾	45	790
SS-32-20	0-32	0-20	1.0	±0.1% or 10 MV	0.02	12¼	45	1100
SS-1003	50-100	0-1.5	1.0	±0.1%	0.03	5¼	30	490
SS-1503	100-150	0-1.5	1.0	±0.1%	0.06	5¼	10	520
SS-1603	0-160	0-1.5	1.0	±0.1% or 20 MV	0.50	7	15	600
SS-2003	150-200	0-1.5	1.5	±0.1%	0.10	7	30	630
SS-2503	200-250	0-1.5	1.5	±0.1%	0.15	8¾	45	720
SS-3003	250-300	0-1.5	2.0	±0.1%	0.20	10½	60	850
SS-1505	100-150	0-3	2.0	±0.2%	0.04	10½	75	950
SS-1605	0-160	0-3	2.0	±0.2%	0.30	12¼	75	1050

NOTE 1: Regulation figure includes total regulation against 105-125 volts slow or instantaneous input voltage variations, 50-1000 cps input frequency variation, 0-100% slow load variations, and ±25% instantaneous load current steps! When regulation is given as "±0.1% or mv", the larger value governs.

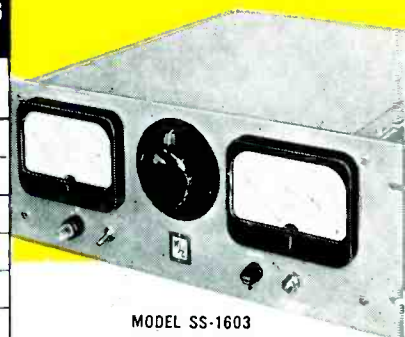

MODEL SS-1603

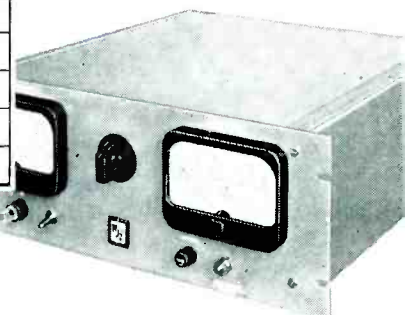

MODEL SS-32-3

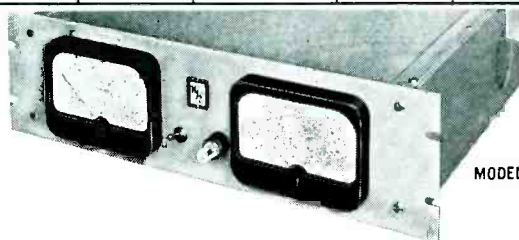

MODEL SS-1503

The enthusiastic reception which greeted our Solid State **fully transistorized** power supplies encouraged us to expand our stock line, incorporating the most popular of the custom designs of the last 2 years. All designs incorporate our unique short-circuit-**proof** (not merely short-circuit-**protected**) power-transistor circuit.

If power supply size, weight, efficiency, and reliability are important to you . . . you need **N J E** Solid State! We have developed several hundred special designs (series and shunt regulator configurations) and are prepared to quote on custom requirements.

All Information Subject To Change Without Notice.

Write for our new Solid State Catalog SS-3-7.

# NJE CORPORATION

Electronic Development & Manufacturing

343 CARNEGIE AVENUE KENILWORTH, NEW JERSEY

COMPETENT ENGINEERING REPRESENTATION EVERYWHERE

N J E LEADS THE POWER SUPPLY FIELD



# A Radical New Approach!

TO DIFFICULT SWITCHING REQUIREMENTS

## CERAMIC VACUUM RELAYS

by *Jennings*

### Vacuum Enclosure

Insures Clean Contacts that stay clean at dry circuit levels.

Reduces Contact Arcing and Pitting at high currents.

### Stacked Ceramic Construction

Permits Small, Compact Design that insures reliable performance under extremes of vibration, temperature, and shock.

### Three Sets of Parallel Contacts

Increase Reliability because three relays in parallel are more reliable than one.

Decrease Bounce Time to less than 100  $\mu$ sec.

Increase Make Current to 100 amperes inrush because contacts are not bouncing and arcing.

Increase Contact Life when interrupting currents up to 15 amperes at 28 vdc or 2 amp at 300 vdc.

(Heavy duty contacts will interrupt up to 60 amps at 28 vdc)

This revolutionary new vacuum relay has been fully tested and is available in production quantities.

Send for catalog literature on SPDT and 4PDT Type RA relays.

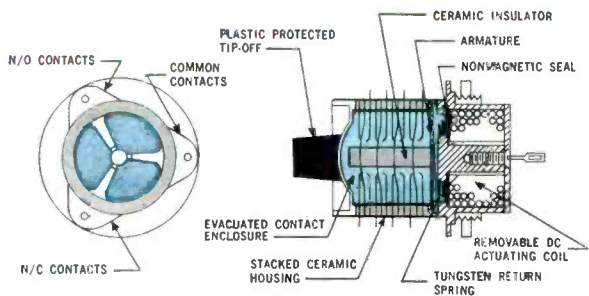

aluminum may be included. A commercial version of this alloy is New Jersey Zinc's Horse Head Zamac 3, available from Henning Bros. & Smith, 91 Scott Ave., Brooklyn, N. Y.

In soldering aluminum it is not necessary to remove rolling mill oils or the surface oxide from the area to be wetted. A single stroke of the solder stick across the heated aluminum surface will cause the solder to penetrate the oxide and wet the aluminum. The normally tenacious oxide film is lifted off much like paint peeling from wet wood. This raised oxide coating may then be wiped aside.

Surfaces thus wet can be joined by bringing them together while hot and adding more solder. Heat may be applied electrically or by means of torches burning common fuels. This soldering technique is equally effective for joining galvanized surfaces without a flux.

## Hot Air Jet Tests Individual Components

By LLOYD WARE

and

JOHN FALLON

Sanders Associates, Inc.  
Nashua, New Hampshire

EFFECT OF HIGH TEMPERATURES on the performance of individual components is easily determined even when components are assembled in close proximity to one another, by using a fine jet of hot air as the heat

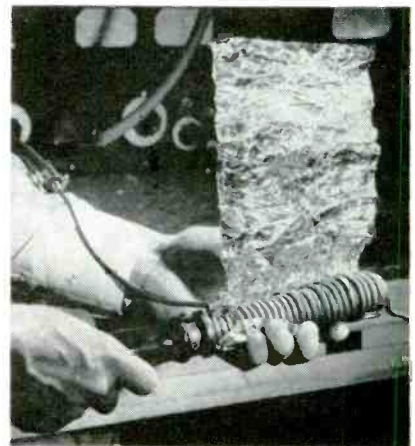

After copper tubing is wound around soldering iron, tinfoil is wrapped around to conserve heat

# HIGH QUALITY DIODES AND TRANSISTORS MUST HAVE CONSISTENTLY HIGH QUALITY WELDS

*Raytheon subminiature  
precision welding systems  
provide extremely uniform  
production—from the 1st to  
the 1,000,000th unit.*

The four difficult welds shown here are being performed with Raytheon precision welding equipment at the rate of 25,000 units a day by the diode division of a major electronics manufacturer.\* In addition to joining the components of these diodes, the welding also seals them hermetically. Statistical sampling of production runs consistently meets JETEC specifications for high quality welds.

Raytheon AC and DC power supplies, controls, welding heads and transformers have been proved in applications where high speed, low cost, precision welding is required. Millions of tubes, transistors, diodes, relays, instruments, capacitors and resistors have been produced with Raytheon welders—designed and produced by *electronic* engineers for use in electronic manufacture.

Learn how Raytheon can help you solve your production problems; have your own samples processed in our Welding Application Laboratory. Write Dept. 6120ED.

\*Name on request

**TYPICAL DIODE  
ASSEMBLY —  
four welds performed  
with Raytheon precision  
welding equipment**

.010" diam. soft annealed  
nickel wire to tungsten  
spike

Pinch-off weld joining  
.010" diam. annealed  
nickel wire, .032" diam.  
tinned copper wire and  
hermetically sealing  
both in Kovar tube

Kovar disk hermetically  
sealed to plated mild steel  
case

.032" diam. tinned cop-  
per butt weld to Kovar  
disk

**RAYTHEON MANUFACTURING COMPANY**

**Commercial Equipment Division**

**Waltham 54, Mass.**

*Excellence in Electronics*



Raytheon production equipment for the electronic industry—AC and DC welding equipment • Automatic welding systems • Magnetizers • Ultrasonic Impact Grinders

# for quick look at telemetered signals jet fighter builder uses

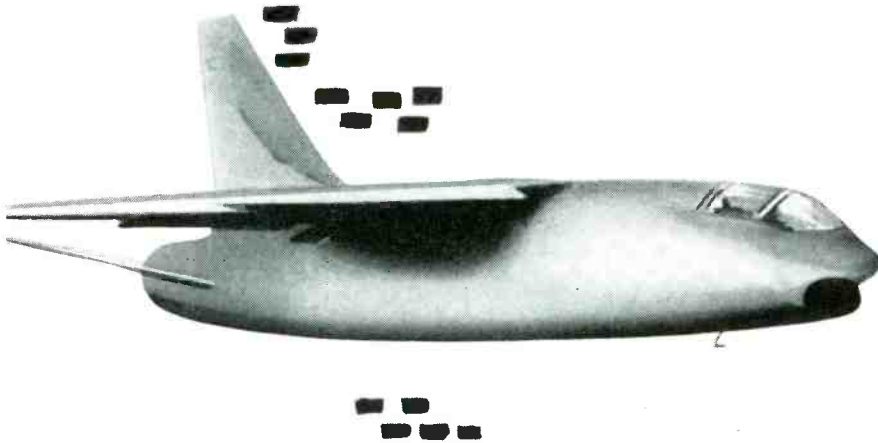

ELECTROGRAPHS installed in the ground station provide an immediate record of 24 simultaneous air-to-ground telemetered flight parameters. Progress of the flight test is followed with virtually no delay, thus minimizing costly re-runs and permitting program changes during the test sequence. The Model 420 ELECTROGRAPH is the **ONLY** photographic recorder suitable for truly "quick-look" applications. High contrast records visible to the observer may be produced within 1/2-second after receipt of the excitation signal . . . NO other photographic oscillograph approaches this performance. When the "quick-look" must be quick, specify the ELECTROGRAPH. As in flight test use, most "quick-look" applications require a high degree of record readability. The high contrast of ELECTROGRAPH recordings is **UNEXCELLED** with the result that record readability is maximum. The black traces and timing lines embossed on light-colored, non-glare emulsion offer the optimum condition for ease of data reduction. For additional details on this 24-channel recording oscillograph, you are invited to write, wire or call for bulletin CGC-311.

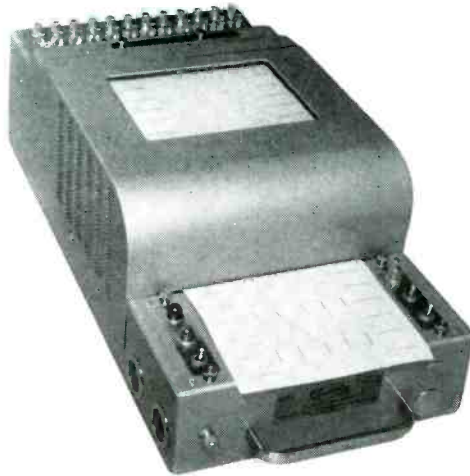

**Century Electronics & Instruments, Inc.**

1333 No. Utica, Tulsa, Oklahoma

source. This can readily be improvised from a 100-watt soldering iron, a sheet of tinfoil, about 7 feet of 3/16-inch copper tubing and a pneumatic air hose of approximately 3/16-inch inside diameter.

► **Construction**—First, mark off a distance of 2 to 3 inches from one end of the copper tubing and, starting at the tip of the soldering iron, wind the remainder of the tubing tightly around the iron's heating element. This will leave about 8 inches of excess tubing near the handle of the iron. Insert the free end of this excess tubing into the

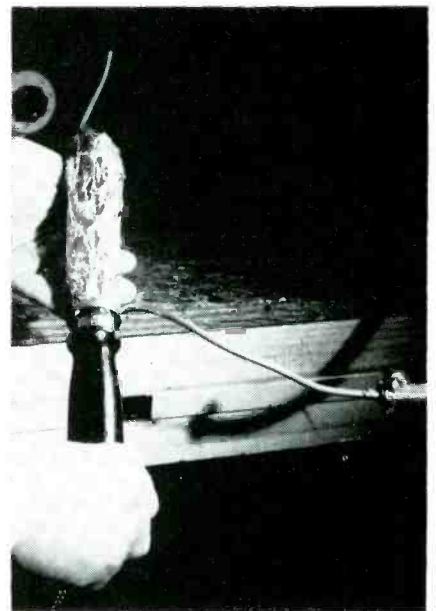

Iron ready for use, with tubing connected to compressed air line

air hose and secure the connection with a hose clamp. Since virtually no heat is transmitted at this point, there is little danger of the hose's being damaged.

Having coiled the tubing around the iron's heating element, wrap this section of the iron tightly with tinfoil to help retain the heat. The iron can now be plugged in and the air supply turned on to give a fine and easily controlled jet of hot air which can be focussed on individual components for pin-point heating.

► **Use**—Air temperature can be regulated by varying the heat in the iron with a Variac or large rheostat. Heating area can be controlled by adjusting the air flow with a

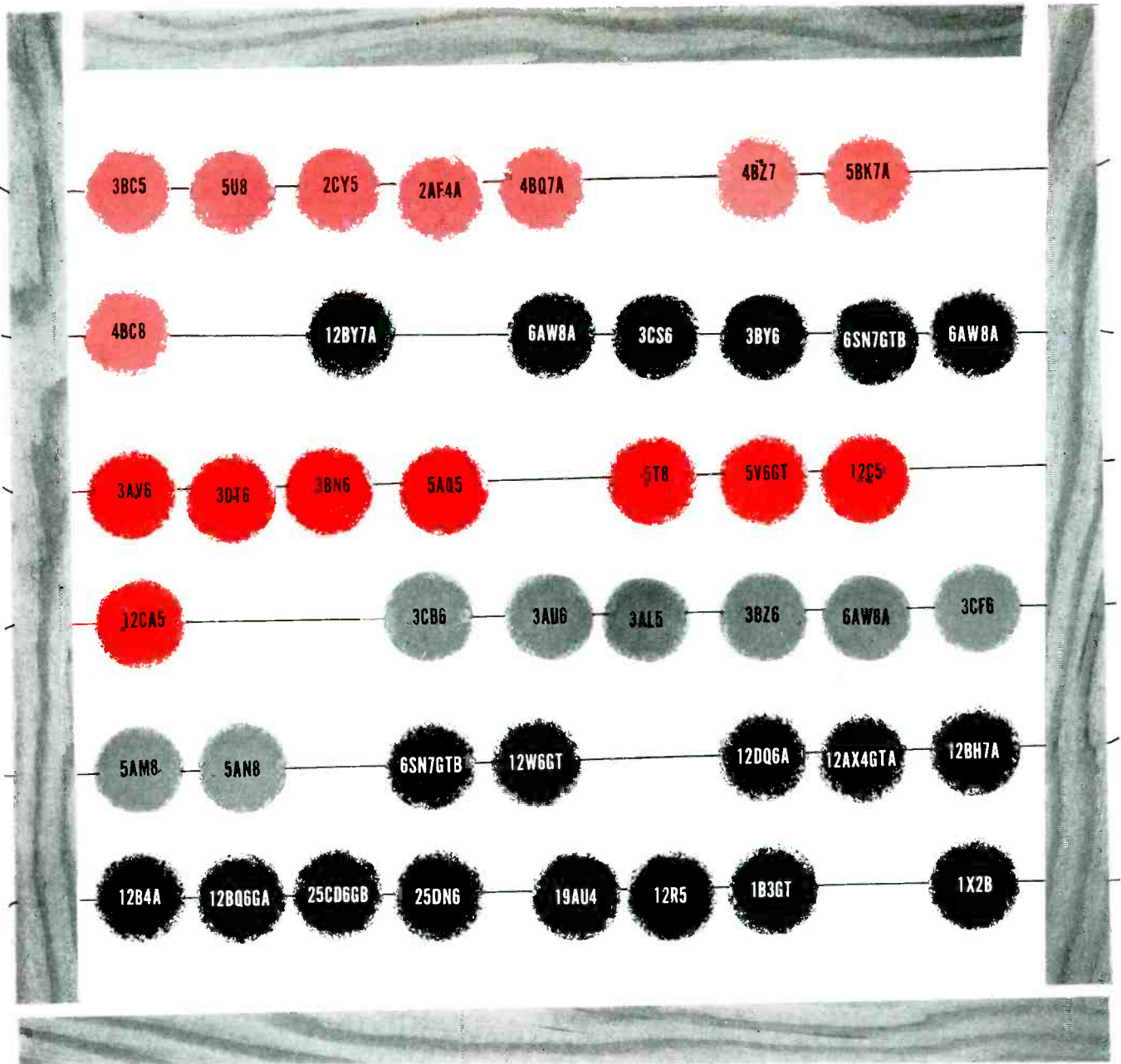

## ANYWAY YOU ADD IT...IT'S TUNG-SOL FOR SERIES-STRING TV TUBES

Advanced designs in heater and cathode structures, which made possible *controlled warm-up time*, established Tung-Sol as the *pioneer producer* of 600 ma series-string heater tubes for TV

Tung-Sol, while continuing to add to this select circle of most widely used 600 ma types, further expanded its series-string line to include 450 and 300 ma tubes for sets requiring fewer tubes.

At present Tung-Sol supplies a complement of nearly 200 of these tubes to the initial equipment manufacturers and the replacement field . . . a

solid indication not only of the success of the series-string principle, but also of Tung-Sol's un-failing ability to meet the strictest performance requirements and production schedules.



# TUNG-SOL®

ELECTRON TUBES • SEMICONDUCTORS

TUNG-SOL ELECTRIC INC., NEWARK 4, N. J.

# VERY LOW FREQUENCY Voltage Measurements

with

**BALLANTINE  
Model 316  
VOLTMETER**



PRICE: \$290

## SPECIFICATIONS

**FREQUENCY RANGE** 0.05 cps to 30KC  
down to 0.01 cps with corrections

**VOLTAGE RANGE** 0.02 to 200V peak to peak lowest reading corresponds to 7.07mv rms of a sine wave

**ACCURACY** 3% throughout ranges and for any point on meter scale

**IMPEDANCE** 10 megohm by any average capacitance of 30  $\mu$ F

**OPERATION** Unaffected by line variation 100 to 130V, 50 cycle, 45 watt

## FEATURES

- Pointer "flutter" is almost unnoticeable down to 0.05cps, while at 0.01cps the variation will be small compared to the sweep observed when employing the tedious technique of measuring infrasonic waves with a dc voltmeter.
- A reset switch is available for discharging "memory" circuits in order to conduct a rapid series of measurements.
- The reading stabilizes in little more than 1 period of the wave.
- Meter has a single logarithmic voltage scale and a linear decibel scale.
- Accessories are available for range extension up to 20,000 volts and down to 140 microvolts.

*For further information on this and other Ballantine instruments write for our new catalog.*

**Ballantine Laboratories, Inc.**

100 Fanny Road, Boonton, New Jersey

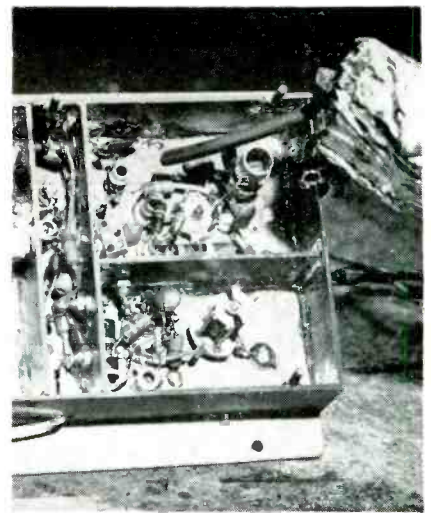

Using hot air jet to heat small coil deep down in chassis

valve or by moving the air outlet toward or away from the component under observation. Component temperatures have been raised as high as 90° C using these simple techniques.

► **Calibration**—Initial and final temperatures of the component under observation can be determined in either of two ways, depending on the degree of refinement required. When only approximations are necessary, assume room ambient as the starting temperature and use a thermometer to measure the temperature rise. Holding the thermometer in the air blast at a fixed distance from the jet, wait until the temperature of the thermometer is stabilized, then note the temperature and the time required. If the component subsequently heated is of approximately the same size as the thermometer bulb and the distance from the air source is about the same, the component's temperature will rise to approximately the same level during an equivalent heating interval.

When the component is substantially larger than the bulb of the thermometer, more time is needed to rise its temperature an equivalent amount if the same air blast and distance are used; this, of course, may be approximated.

To make precise measurements of component temperatures, attach a thermocouple bridge to each component as it is being heated.

► **Cooling**—After a component has



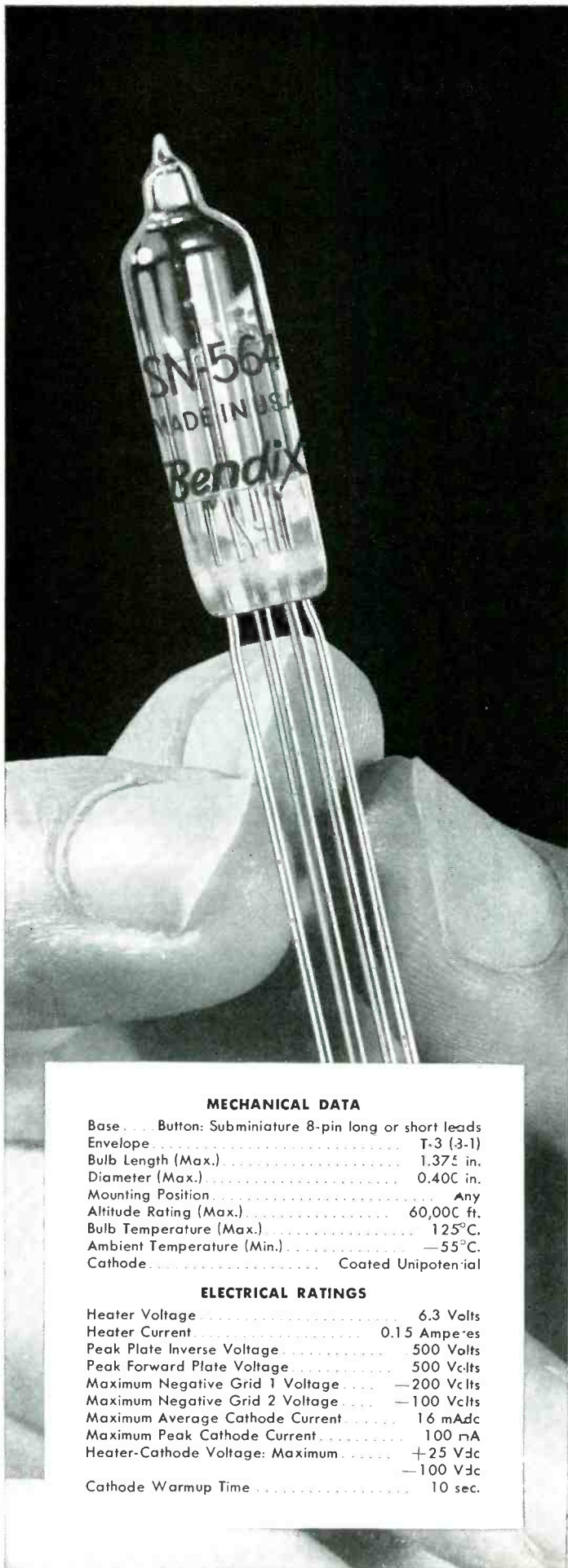

Now available—  
subminiature xenon  
tetrode thyatron

## RETMA 5643



### Improved Type TD-17

**APPLICATIONS:** Counters, grid control rectifiers, gyro erection systems, missile systems, automatic flight control systems, and other control circuits requiring utmost degree of reliability.

**ADVANTAGES:** Freedom from early failure . . . long service life . . . uniform operating characteristics . . . ability to withstand severe shock and vibration.

**FEATURES:** Advanced mechanical and electrical design plus 100% microscopic inspection during manufacture . . . special heater-cathode construction minimizes shorts . . . 24-hour run-in tests under typical overload conditions.

The TD-17 is but one of many electron tubes designed and built by Bendix Red Bank for special-purpose applications. For full information on the TD-17, or on other tubes for other uses, write RED BANK DIVISION, BENDIX AVIATION CORPORATION, EATONTOWN, NEW JERSEY.

West Coast Office: 117 E. Providencia Ave., Burbank, Calif.

Canadian Distributor:

Aviation Electric Ltd., P. O. Box 6102, Montreal, P.Q.

Export Sales and Service:

Bendix International Division, 205 E. 42nd St., New York 17, N. Y.

#### MECHANICAL DATA

Base . . . . .	Button: Subminiature 8-pin long or short leads
Envelope . . . . .	T-3 (3-1)
Bulb Length (Max.) . . . . .	1.375 in.
Diameter (Max.) . . . . .	0.400 in.
Mounting Position . . . . .	Any
Altitude Rating (Max.) . . . . .	60,000 ft.
Bulb Temperature (Max.) . . . . .	125°C.
Ambient Temperature (Min.) . . . . .	-55°C.
Cathode . . . . .	Coated Unipotential

#### ELECTRICAL RATINGS

Heater Voltage . . . . .	6.3 Volts
Heater Current . . . . .	0.15 Amperes
Peak Plate Inverse Voltage . . . . .	500 Volts
Peak Forward Plate Voltage . . . . .	500 Vc/lts
Maximum Negative Grid 1 Voltage . . . . .	-200 Vc/lts
Maximum Negative Grid 2 Voltage . . . . .	-100 Vc/lts
Maximum Average Cathode Current . . . . .	16 mA <sub>dc</sub>
Maximum Peak Cathode Current . . . . .	100 mA
Heater-Cathode Voltage: Maximum . . . . .	+25 V <sub>dc</sub>
	-100 V <sub>dc</sub>
Cathode Warmup Time . . . . .	10 sec.



See how big 3-D views speed assembly, measurement and inspection of tiny parts.

# FREE 15-DAY, ON-THE-JOB TRIAL!



**Bausch & Lomb  
STEREOMICROSCOPES**

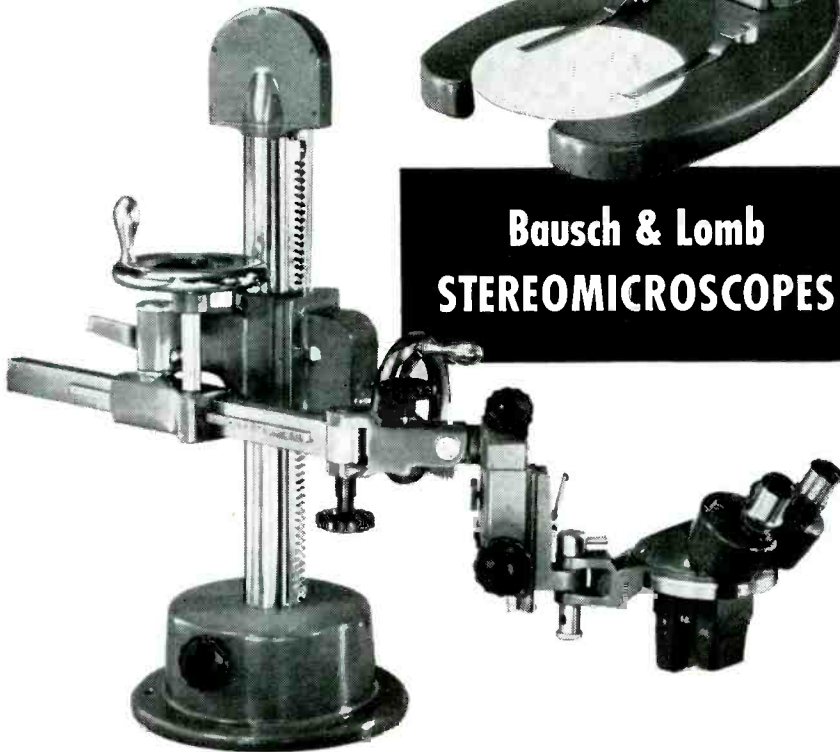

These essential production tools make small-parts manufacture faster and easier, make precision surer. Views are vivid, magnified in natural 3-dimensional detail. Complete line to fit exact model to your specific industrial needs. Dustproof, shockproof, built for rugged production-line use—you can mount them right on machines!

See for yourself! Use a B&L Stereomicroscope on your own job for 15 days—absolutely free, no obligation. All we ask is the opportunity to let our Stereomicroscopes prove themselves to you. Just call your regular B&L dealer, or mail the coupon today.

**BAUSCH & LOMB**



BAUSCH & LOMB OPTICAL CO.  
61424 ST. PAUL ST., ROCHESTER 2, N. Y.

- Yes, I'd like to borrow a B&L Stereomicroscope for a 15-day trial without cost or obligation.  
 Send me B&L 3-D Micro-Vision Book, containing valuable data, showing actual stereo views.

NAME.....  
TITLE.....  
COMPANY.....  
ADDRESS.....  
CITY..... ZONE..... STATE.....

been heated, its temperature must be lowered to room ambient before the next component is heated; otherwise, equipment performance will be influenced by the temperature variation in more than one component. A blast of cool air from a separate air line, after readings have been observed and recorded, will lower a component's temperature in a few seconds.

## Splicing Multiconductor Shielded Cable

A NEW METHOD of splicing single and multi-conductor shielded cables, developed by Burndy Corp. of Norwalk, Conn., uses standard inexpensive parts to make compact, flexible, high-conductivity splices with

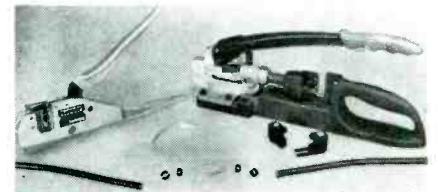

STEP 1—Crimping tools, compression connectors, ferrules and splicing braid used in making one complete splice in shielded cable shown in foreground

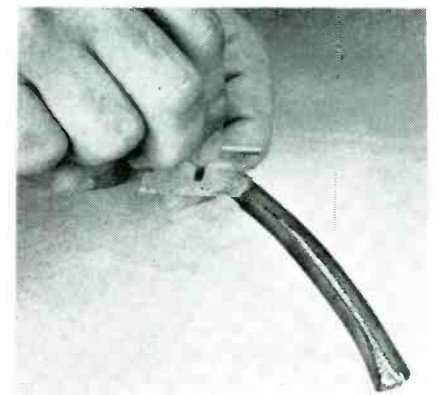

STEP 2—Removing insulation from cable

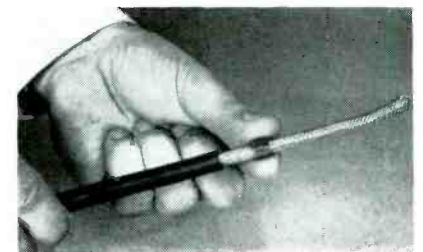

STEP 3—Placing inner ferrule over shield

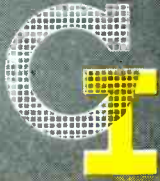

**GENERAL INSTRUMENT  
SEMICONDUCTOR DIVISION**

*proudly announces*  
**the industry's  
most versatile  
silicon diode**

*RADIO RECEPTOR'S*

# silicon diode

## 1N658

- HIGH FORWARD CONDUCTANCE 100 mA @ 1V.
- LOW REVERSE LEAKAGE .05  $\mu$ a @ -50V @ 25° C;  
25  $\mu$ a @ -50V @ 150° C.
- HIGH PEAK INVERSE VOLTAGE 120V.
- FAST REVERSE RECOVERY 80K ohms in .3  $\mu$ sec.\*
- HIGH OPERATING TEMPERATURE 175° C.

\*When switching from 5 mA to -40V. RL = 2K. CL = 10  $\mu$ mf.

**RATINGS**

Maximum inverse working voltage: 100V.  
Average forward current: 200 mA.  
Maximum power dissipation: 200 mW.

*Uniform excellence in  
all parameters permitting a  
far wider range of applications*

- REDUCES EXPENSIVE INVENTORY
- REDUCES NUMBER OF DIODE TYPES REQUIRED
- RESULTS IN GREATER STABILITY  
AND LONGER LIFE

Latest achievement of the GI team of semiconductor specialists is this universal silicon diode 1N658. Radio Receptor's newly developed process combines in skillfully balanced proportion every desirable characteristic you've sought in silicon diodes. Result is a fully reliable component that does a better job in almost every standard application.

In addition to the 1N658, Radio Receptor offers to the industry a full range of RETMA subminiature silicon diode types to meet other applications. Full information is available upon request to Section E-12.

RRco. 1N658 is available now in production quantities for immediate delivery from our factory. Small quantities for testing and evaluation can be purchased from any authorized RRco. distributor and orders sent direct to Radio Receptor will be handled promptly.

RADIO & ELECTRONIC



PRODUCTS SINCE 1922

*Semiconductor Division*

**RADIO RECEPTOR COMPANY, INC.**

*Subsidiary of General Instrument Corporation*  
240 Wythe Avenue, Brooklyn 11, N. Y. EVERgreen 8-6000

Germanium & Silicon Diodes • Dielectric Heating Generators and Presses  
Selenium Rectifiers • Communications, Radar and Navigation Equipment

## New trends and developments in designing electrical products . . .

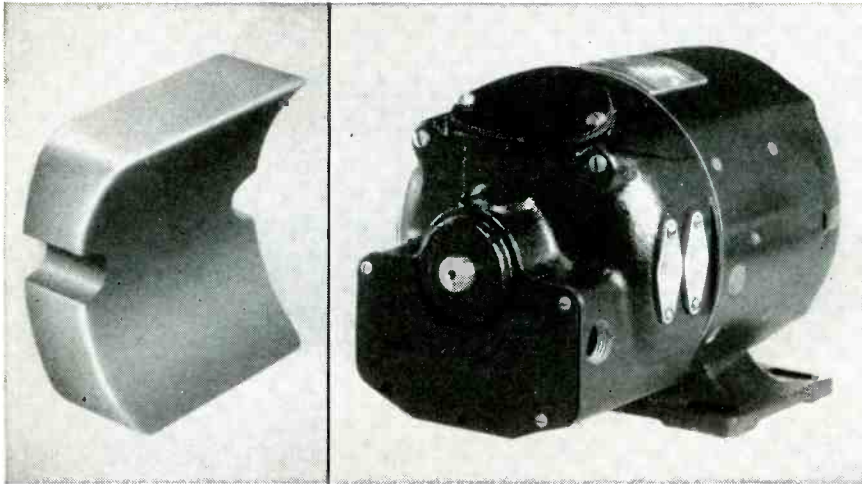

### General Electric permanent magnet outperforms wire-wound field in D-C tachometer generator

**Improved Alnico 6 magnet increases reliability and accuracy over wide ambient temperature range.**

Instruments can determine rotational speeds from 100 to 5000 rpm with an error of less than .05% — despite ambient temperatures of 20° to 50° C. Problem is that these instruments are only as accurate as the tachometer generators that supply their power.

Conventional generators use copper windings. This means they are dependent on external — and often varying — power sources. They are adversely affected by wide temperature changes. And, they are costly to repair when windings burn out.

The 46-frame D-C generator, above, gets around these difficulties by using a G-E Alnico 6 permanent magnet. Here's why:

1. The G-E Alnico magnet does not depend on outside excitation.
2. It supplies reliably constant power.
3. Exposure to varying ambient temperatures does not affect the magnet's power or dependability.
4. External regulating equipment — needed with wire-wound fields — is eliminated by the use of Alnico magnets.
5. Unlike copper windings, permanent magnets never wear out.

These advantages, in themselves, were enough to make the magnet-powered generator a success.

However, with conventional Alnico 6, plastic-steel was needed between the "as-cast" surfaces of the magnet and the machined parts of the generator to cut eddy current losses, and to shield the flux. This added to the time and cost of producing the generator; made it almost impossible to disassemble for normal servicing and maintenance.

So G-E magnet engineers increased the coercive force of the Alnico 6 magnet by about 7%. The need for the plastic-steel "mud" was eliminated . . . and so were the difficulties of assembly and disassembly.

This generator is just one of the many applications where G-E magnets can outperform wire-wound fields for accuracy and reliability. And the work of G-E Magnet Engineers in improving Alnico 6 is just one of the many services they offer to designers and manufacturers of electrical products.

For more information about G-E magnet engineering services, or for your copy of the new G-E Magnet Design Manual, write: *Magnetic Materials Section of General Electric Company, 7806 N. Neff St., Edmore, Michigan.*

*Progress Is Our Most Important Product*

**GENERAL  ELECTRIC**

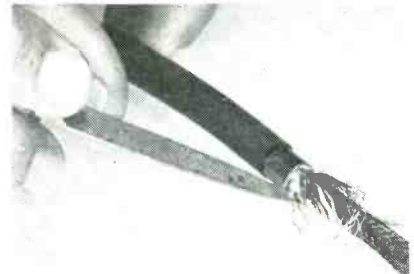

STEP 4—Combing out excess shield length after positioning ferrule

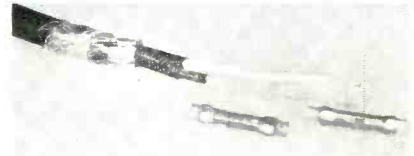

STEP 5—Strands of shield are folded back over ferrule and held in place with Scotch tape, after which inner conductors are stripped as shown in preparation for insertion in Insulink connectors

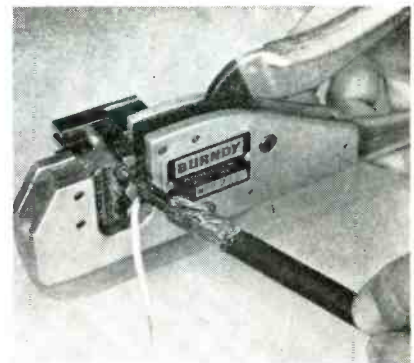

STEP 6—Insulink connector is inserted between jaws of crimping tool up to stop at rear, stripped conductor is inserted, and tool handles are closed



STEP 7—Cable with crimped links

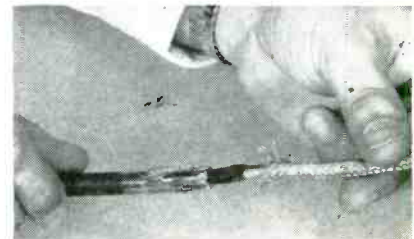

STEP 8—Length of splicing braid is opened with pencil and pushed over links as shown

electrical and physical properties comparable to those of the cable.

Inner conductors are splices with small compression connectors. Shields are joined with a section of

# new!



MODEL 1329

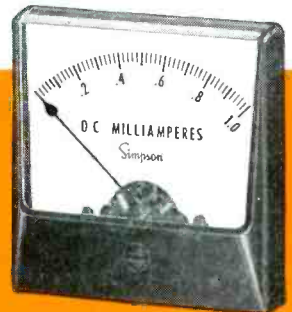

MODEL 1227

## Simpson WIDE-VUE panel instruments

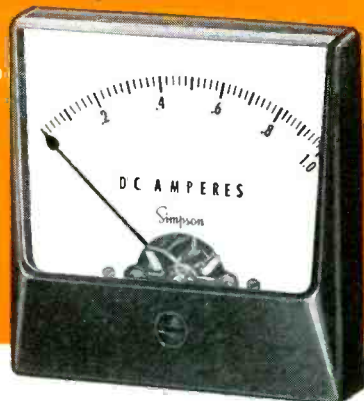

MODEL 1327

a new concept  
in styling and visibility

### available in stock and custom-built units!

The clean, graceful lines of "Wide-Vue" panel instruments add two plus values to your equipment designs. First, style—*ultra-modern beauty* that blends with today's streamlined panels. Second, functionalism—longer scales with *wide-angle readability*. The 2½" size, for example, has the same scale length as a conventional 3½" meter. Wide-Vue's durable cover is formed in one piece from clear plastic, and can be supplied with black or color (custom-built units only) finishes. DC, AC, and AC rectifier types in 2½", 3½", and 4½" sizes.

### SELF SHIELDED MOVEMENT ELIMINATES CALIBRATION PROBLEMS...

All stock DC Wide-Vue meters use the Simpson self shielded Core Magnet Meter Movement, except the 0-25 and 0-50 DC Microammeters and V. U. meters.



See your Electronic Distributor for  
**IMMEDIATE DELIVERY** on stock Wide-Vue meters...  
over 130 ranges and types to choose from!

### SIMPSON ELECTRIC COMPANY

5200 W. Kinzie St., Chicago 44, Illinois  
Phone: EStebrook 9-1121

In Canada: Bach-Simpson Ltd., London, Ontario

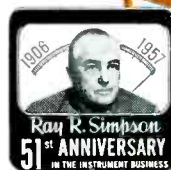

## INSTRUMENTS THAT STAY ACCURATE

# ELIN POWER OSCILLATORS...

to "System-mate" Your Equipment Requirements!

CABINET MODEL  
DK-102 (2 watts)  
DK-106 (6 watts)

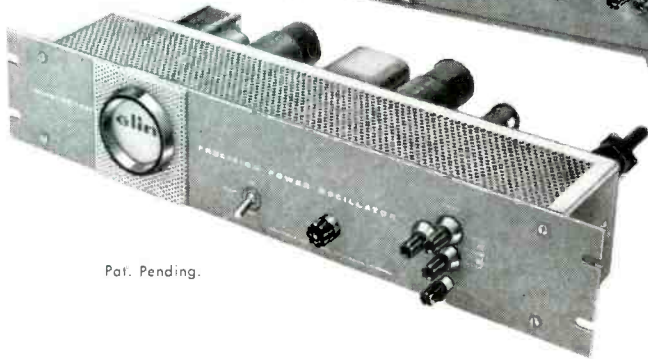

Pat. Pending.

RACK MODEL  
DK-102R (2 watts)  
DK-106R (6 watts)

In applications concerning strain gauges, bridge-type transducers, time correlation, precision 400 cycle gyro testing, process control and preflight missile checkout, ELIN Precision Power Oscillators prove compatible and, in combination with other equipments, readily yield superior systems!

The desirable features of ultra-precise frequency and amplitude stability, low distortion and high output power capacities, make ELIN Precision Power Oscillators the ideal "System-mate" in these applications, and are derived from an exclusive High-Q LC tuned circuit and a special voltage-sensitive bridge combined in a circuit employing a large amount of negative feedback.



**FREQUENCY (FIXED)**—250 cps. to 15,000 cps. **VOLTAGE (OUTPUT)**—10, 30 & 100 volts RMS, all with floating center-tapped output. **DISTORTION**—0.1% maximum harmonic content, 0.05% maximum AC hum, 0.01% maximum noise. **CALIBRATION ACCURACY**— $\pm 0.02\%$  under usual lab ambient conditions\*, checked against station WWV as a primary standard. **FREQUENCY STABILITY**— $\pm 0.5\%$  maximum, under usual lab ambient conditions\*,  $\pm 0.02\%$  maximum per  $\pm 10$  volts variation in line voltage,  $\pm 0.05\%$  maximum, zero to full load. **AMPLITUDE STABILITY**— $\pm 0.1\%$  maximum under usual lab ambient conditions\*,  $\pm 0.02\%$  maximum, per  $\pm 10$  volts variation in line voltage,  $\pm 0.2\%$  maximum, zero to full load.

Special models operating from other prime power sources, with higher power capacities and at other frequencies supplied to your specs in cabinet or rack styles. Write today!

\*Lab ambient, 10°C to 40°C.

Reg. U. S. Pat. Off.

**elin**® / Precision Power Oscillators

**ELECTRONICS INTERNATIONAL CO.**

145 West Magnolia Boulevard, Burbank, California

Special Products Division of International Electronic Research Corporation, Burbank, California

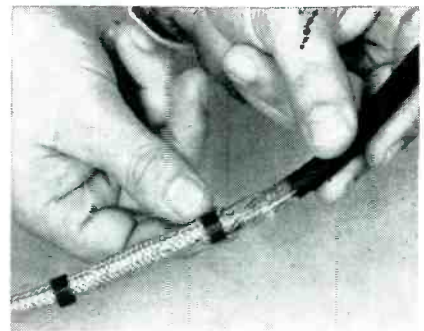

STEP 9—Outer Hyrings are slipped over braid

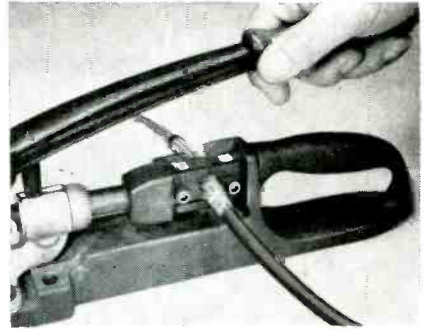

STEP 10—Shield and splicing braid are crimped between Hyrings

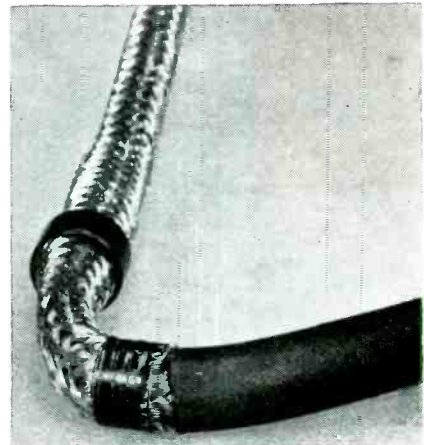

STEP 11—Half of splice after removal of excess braid, shield and tape

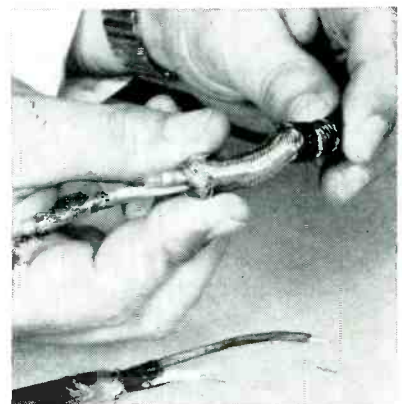

STEP 12—Pushing splicing braid back to expose links in preparation for insertion of stripped conductors of other cable. Note staggering of splices

**Relay Sales**

Telephone Relays

Midget Relays

Keying Relays

Rotary Relays

Sealed Relays

Sensitive Relays

Latching Relays

Stepping Relays

Delay Relays

Timers

Contactors

Motor Starting Relays

Differential Relays

Polarized Relays

AN Approved Relays

Write for Catalog  
1957-C8

**Relay Sales**

# why wait for RELAYS

**LEADING MAKES-  
LATEST TYPES  
IN STOCK!**

C. P. CLARE  
Mercury Wetted  
Contact

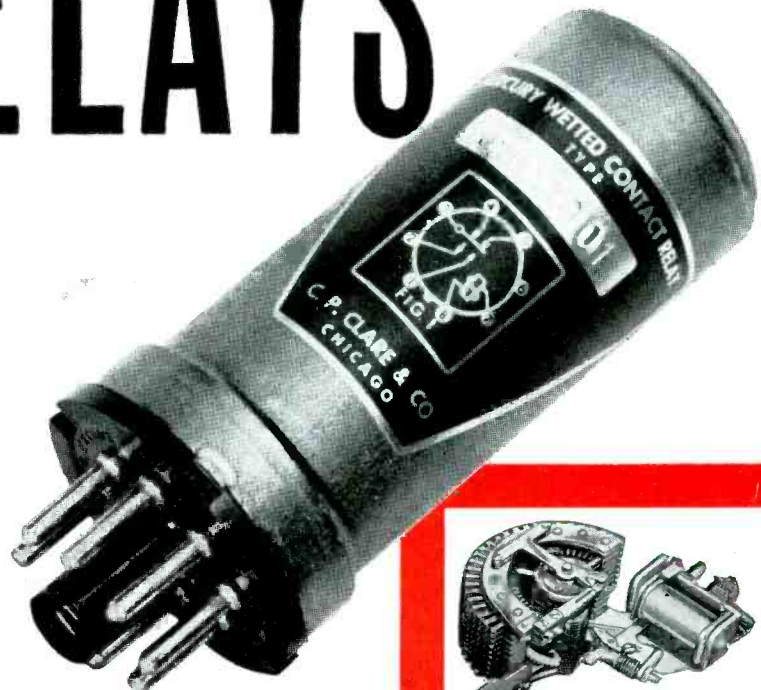

We maintain complete distributor stocks of the following makes:

Advance Relays    Phillips Controls  
Automatic Electric    Struthers-Dunn  
Clare    Leach Relays  
Neomite-Elgin    Terado and Others

### Potter & Brumfield

#### We Anticipate Your Relay Needs

Relay Sales cannot get better delivery from manufacturers than you. Relays now in stock were ordered as long as 10 months ago and selected by men who have specialized in supplying relays to the industry for many years. The items illustrated are typical of hundreds of thousands in stock. They are available in all popular coil ratings and contact arrangements. Why wait for relays? Call us today!

Write or Phone for Same Day Shipment

Phone: West Chicago 1100

**RELAY SALES, INC.**

P.O. BOX 186-A

West Chicago, Ill.

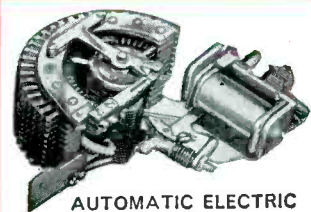

**AUTOMATIC ELECTRIC**  
Type 45 Stepper  
Wide Selection

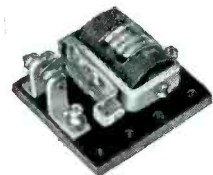

**STRUTHERS DUNN**  
Keying Relay  
Many Types in Stock

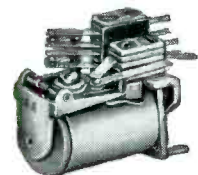

**PHILLIPS CONTROL**  
9QA Midget for Sub Chassis  
Mounting. Many Others  
in Stock



(Actual Size)  
**NEOMITE-ELGIN**  
Sub Miniature Hermetically Sealed  
Relay. All Advance Types in Stock

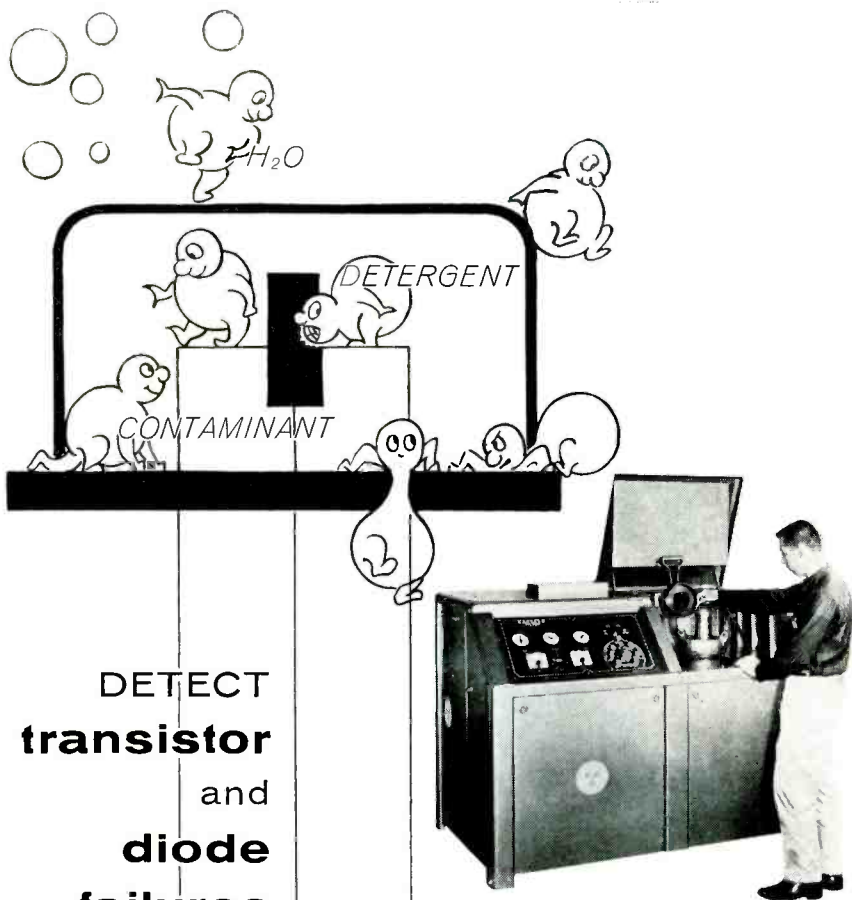

DETECT  
**transistor**  
 and  
**diode**  
**failures**  
 BEFORE  
 they  
 happen  
 with  
**RADIFLO\***

\* Patent applied for

**ADVANTAGES OF  
 USING RADIFLO**

1. Test units after they are completely sealed.
2. Grade transistors non-destructively by leak rate.
3. Test in production quantities for less than 1c each.
4. Test production quantities to a sensitivity of  $10^{-11}$  cc/sec.
5. RADIFLO can be completely automated to eliminate error and reduce cost.

Reliability of many electronic circuits has been seriously hampered due to leaking transistors . . . even though these units were carefully checked before installation. The reason often lies in the testing methods. For example, the bomb test not only has low sensitivity and other inherent inaccuracies, but also exposes the unit to chemicals which can cause latent field failure. RADIFLO leak detection eliminates these problems; is positive, fast, inexpensive and non-destructive to the sealed unit.

**RADIFLO Operation**

Parts to be tested for leaks are placed in a container and subjected, under pressure, to an inert, non-toxic, radioactive gas. They are then air washed and the amount of the gas which penetrated the transistor or other sealed unit is accurately measured to determine leak rates as small as 1 cc per 5000 years. Testing of parts may be done quickly and in quantity to prevent production delays. RADIFLO may also be used directly on the production line for **automatic** acceptance or rejection of parts whose leak rate exceeds pre-determined limits.

When transistors are checked for leaks by the RADIFLO method, their reliability and performance are effectively insured. Write for bulletin No. 7071.1

RADIFLO parts testing service available at American Electronics plant.



**AMERICAN ELECTRONICS, INC.**  
 655 W. Washington Blvd., Los Angeles, California



STEP 13—Completing splice of second inner conductor

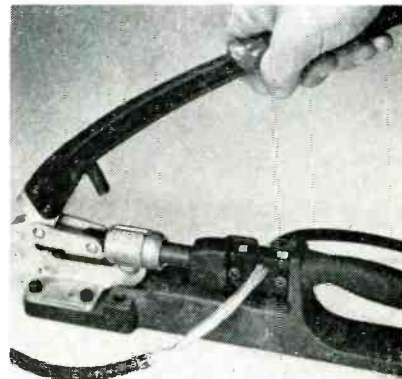

STEP 14—Completing crimping of shield over splicing cable

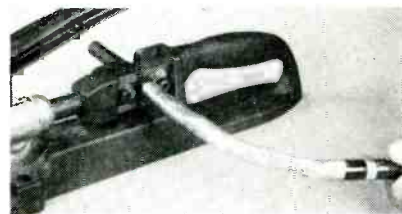

STEP 15—Crimping length of vinyl tubing over splicing braid to insulate and water-seal splice

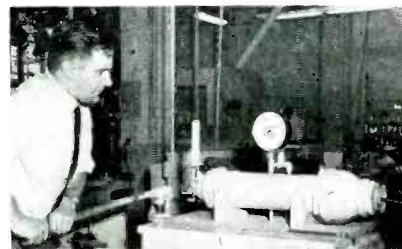

STEP 16—Testing splice for water sealing at pressure of 700 psi

splicing braid, each end of which is crimped to the shield with ferules. For insulation or water protection, the entire splice can be sealed with vinyl tubing to withstand hydrostatic pressures in excess of 600 psi.

**Double-Deck Parts Cart**

FOR ASSEMBLY line work, a new cornerless parts cart has a working surface large enough to hold up to



# Boost DC power efficiency, cut costs with Westinghouse Silicon Rectifiers!

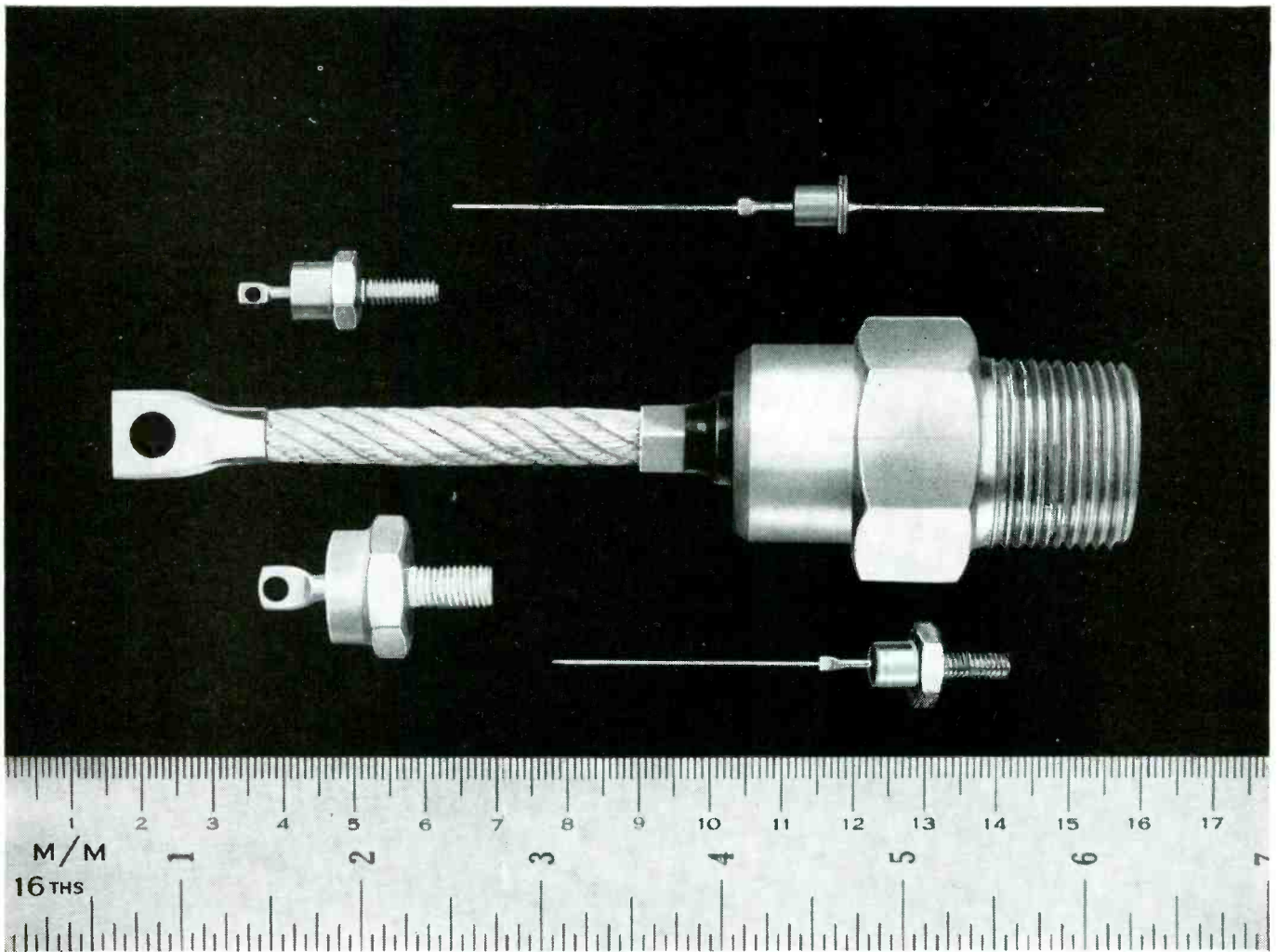

Whether you *use* or *manufacture* DC power equipment for low or high-power applications, Westinghouse Silicon Rectifiers offer you a way to step up power output efficiency yet save space, weight — *and costs!*

Manufacturing economies through tremendous volume and engineering know-how permit Westinghouse to bring you a product that is unsurpassed for quality at the lowest prices in the industry. All Westinghouse Silicon Rectifiers meet Military Environmental Tests and are ruggedly designed to withstand a wide range of operating conditions.

Westinghouse Silicon Rectifiers are ready for immediate delivery. Why not find out how they can cut DC power costs for you? Call your local Westinghouse Representative or mail the coupon now.

**YOU CAN BE SURE... IF IT'S**  
**Westinghouse**

## WESTINGHOUSE SILICON RECTIFIERS

### HIGH & MEDIUM POWER

Number	PIV (Max.)	Peak Reverse Current (Max.)	Maximum Current at 150°C Case	Thermal Drop Junction to Case
302	50-600 V	20 Ma	35 Amps.	1°C Per Watt
303	50-600 V	10 Ma	18 Amps.	1.5°C Per Watt
304	50-600 V	10 Ma	12 Amps.	2°C Per Watt
322	50-500 V	40 Ma	110 Amps.	.3°C Per Watt

### LOW POWER

305	50-800 V	1.5 Ma	1.6 Amps.	5°C Per Watt
320	50-800 V	1.5 Ma	1.6 Amps.	5°C Per Watt

### Mail Coupon Now

Westinghouse Electric Corp.  
 P. O. Box 868  
 Pittsburgh 30, Penna.

Will you please send me full information on Westinghouse Silicon Rectifiers No. (s) \_\_\_\_\_

NAME \_\_\_\_\_

TITLE \_\_\_\_\_

COMPANY \_\_\_\_\_

ADDRESS \_\_\_\_\_

# STANDARD OR SPECIAL FABRICATED CHASSIS OR CASES

Insuline's standard or special fabricated chassis and cases, using the economical "Rapid-Tooling" method, are known for quality workmanship at low cost. Housings and chassis are made in multiple sizes of aluminum or steel and are designed for maximum accessibility. Available in 3 types — channel-lock, flexi-mount or slip cover.

Standard units are now available — or we can fabricate to your specifications. Write us for quotes. Orders filled promptly.



FREE CATALOGUE

**insuline**  
CORPORATION OF AMERICA  
Division of Van Norman Industries  
186 Granite St., Manchester, N. H.

CIRCLE 134 READERS SERVICE CARD

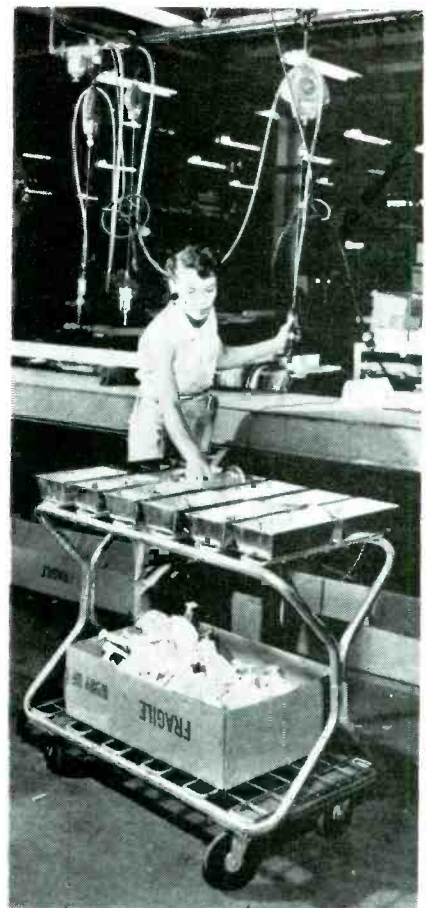

Absence of corners simplifies loading of lower deck of cart when bringing supplies up to assembly line

## A NEW CASE for a BEEDE ELECTRIC METER

MODERN  
EASY TO READ  
REASONABLY PRICED

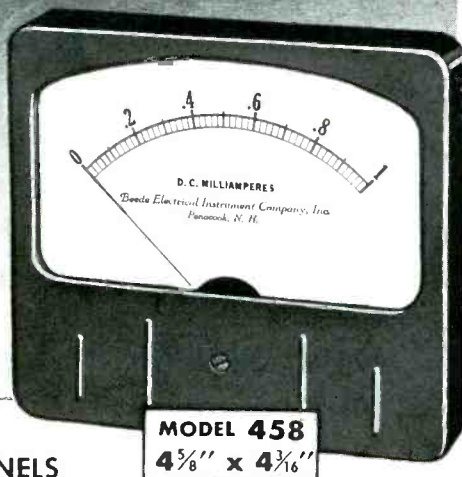

MODEL 458  
4 5/8" x 4 3/16"

FOR SMALL POWER-UNIT PANELS  
INDUSTRIAL TEST UNITS—COMMUNICATION EQUIPMENT, ETC.  
LONG LASTING AND ACCURATE TO THE DOT

**BEEDE** ELECTRICAL INSTRUMENT CO., INC.  
PENACOOK, N. H.

one dozen standard bread-pan containers for small parts. The lower platform holds larger components or large containers.

For easier loading and handling there are no corner posts, while the top and bottom corners are rounded for safety against personnel injury. Heavy steel cross-rods provide low-friction loading surfaces for bulky or heavy containers. Constructed of strong tubular steel, nickel-plated for durability, the carts are fitted with four ball-bearing swivel casters for extreme maneuverability. Manufacturer is McClintock Mfg. Co., 802 West Whittier Blvd., Whittier, Calif.

### Epoxy Adhesive Kit

PACKAGING of a new Hysol epoxy adhesive and hardener in separate toothpaste-type collapsible tubes eliminates on-the-job weighing and proportioning of these ingredients

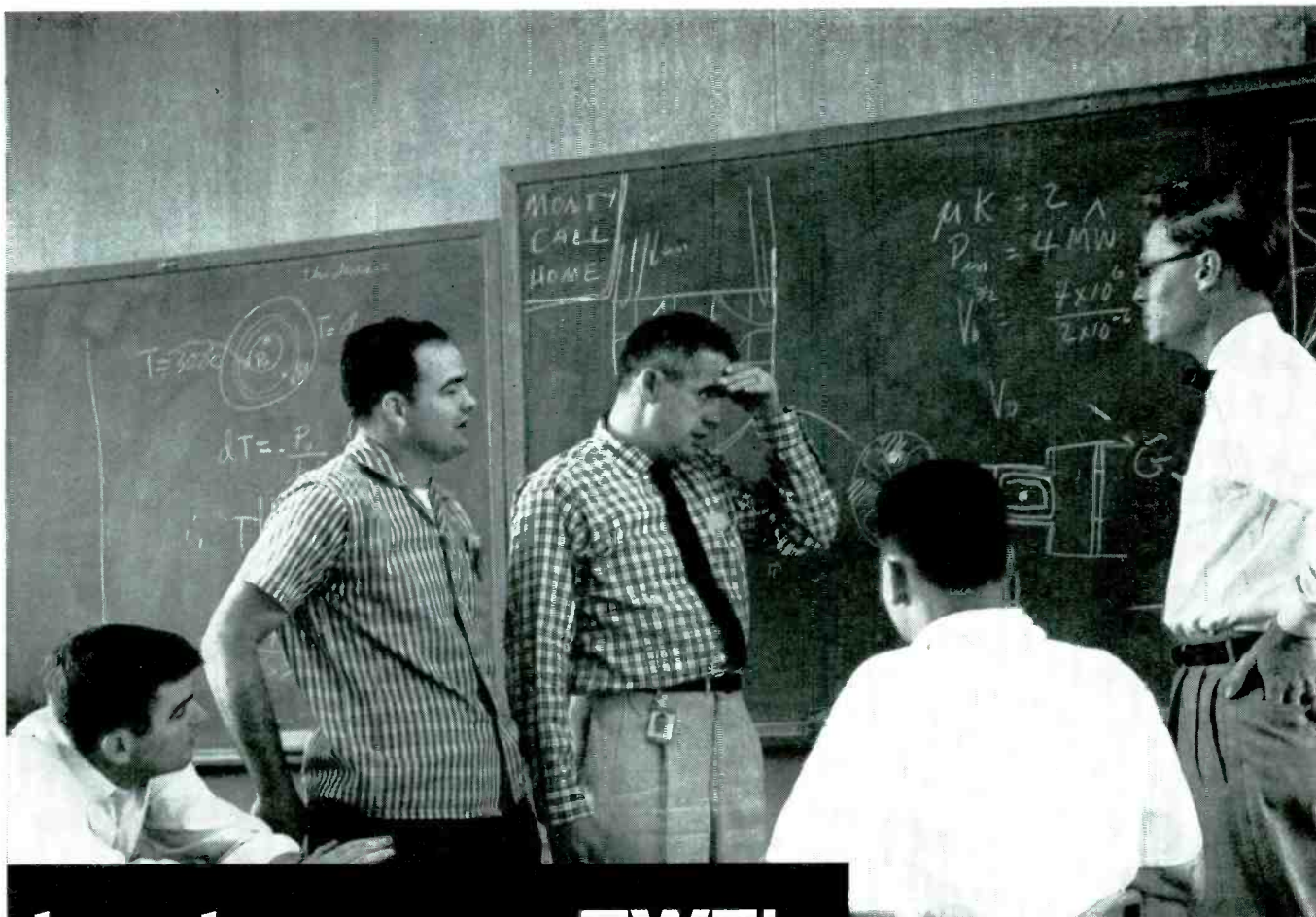

## top team on TWT's

Advanced wave tube design being discussed at Varian by Jack Rietz, Mon-y Rogers, Willis Yocom, John Sullivan and Wells Dodds.

Traveling-wave tubes, as any of the men above will tell you, are slated for an important place in the world of electronics. And these men, backed by Varian know-how, are out to assure the fullest possible realization of the wave tube's promising future.

With one of the industry's most competent wave tube development groups, Varian is geared to meet a wide range of difficult challenges in its field . . . applying to newer systems problems the same know-how and teamwork that just a few years ago established Varian's leadership in klystrons.

Many new ideas and applications are on the way, to back up the success of tubes like the VA-121 and VA-161 shown here. The entire Varian wave tube team is ready to go to work for you, to shape up a wave tube application or come up with the answers you've been looking for. Write or call your Varian representative or Varian's Application Engineering Department.

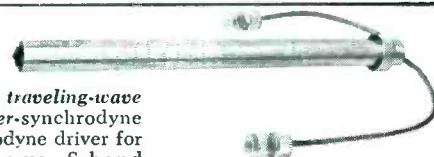

**VA-121 traveling-wave amplifier-synchrodyne or scroodyne driver** for high power S-band pulse applications. Performs to detailed specifications of phase and amplitude stability to meet the stringent requirements of phase-coherent MTI radar systems.

Power Output	25-40 watts
Saturation Gain	30 db min.
Duty Cycle	.01 max.
Beam Voltage	2250 volts
Grid Pulse Voltage	+27 volts

**VA-161 backward wave oscillator** for use in tunable radar local oscillator, countermeasure and bench and test applications. In the frequency range from 8.2 to 12.4 kMc.



Power Output	30 to 120 mW
Anode Voltage	150 to 600 volts
Permanent Magnet	
Size:	4 1/8 x 5 x 6 1/2 inches
Weight:	Approx. 6 lbs.

THE  
MARK OF  
LEADERSHIP

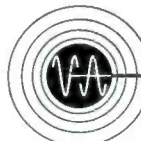

**VARIAN associates**  
PALO ALTO 1, CALIFORNIA

Representatives in all principal cities

KLYSTRONS, TRAVELING WAVE TUBES, BACKWARD WAVE OSCILLATORS, LINEAR ACCELERATORS, MICROWAVE SYSTEM COMPONENTS, R. F. SPECTROMETERS, MAGNETS, MAGNETOMETERS, STALOS, POWER AMPLIFIERS, GRAPHIC RECORDERS, RESEARCH AND DEVELOPMENT SERVICES

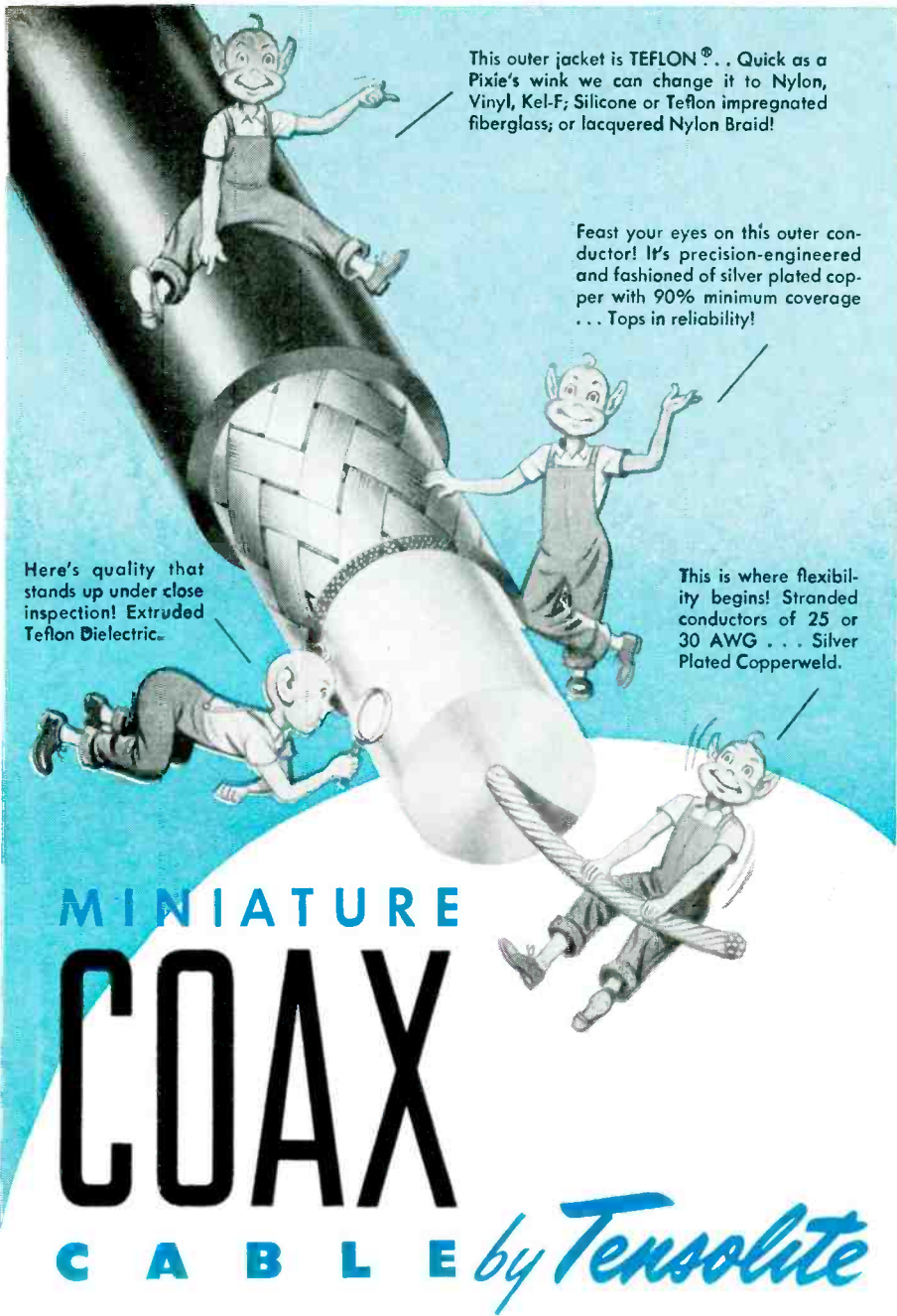

This outer jacket is TEFLON®. . . Quick as a Pixie's wink we can change it to Nylon, Vinyl, Kel-F; Silicone or Teflon impregnated fiberglass; or lacquered Nylon Braid!

Feast your eyes on this outer conductor! It's precision-engineered and fashioned of silver plated copper with 90% minimum coverage . . . Tops in reliability!

Here's quality that stands up under close inspection! Extruded Teflon Dielectric.

This is where flexibility begins! Stranded conductors of 25 or 30 AWG . . . Silver Plated Copperweld.

# MINIATURE COAX CABLE by Tensolite

Here is a "Pixie Eye View" of Tensolite's new miniature Coaxial Cable . . . and here are the answers to some of the questions you will ask:

**TEMPERATURE RANGE:** From  $-90^{\circ}$  to  $+250^{\circ}\text{C}$  . . . depending on jacket used. Teflon jackets approved for entire temperature range listed.

**IMPEDANCE VALUES:** 50, 70, 75, 93 and 95 OHMS available from TENSOLITE as standard constructions.

**TO MILITARY SPECIFICATIONS:** MIL-C-8721 (with KEL-F jacket); RG-178, RG-179 and RG-180. MIL-C-17B (with TEFLON jacket); RG-187/U, RG-188/U, RG-195/U and RG-196/U.

**COLOR CODED JACKETS:** In standard colors and striped combinations.

**AND FOR YOUR CUSTOM REQUIREMENTS:** TENSOLITE Factory and Field Engineers are ready to assist you in the Design, Development and Production of any miniature Coaxial Cables for specific or unusual applications. Simply write or call TENSOLITE for complete descriptive literature and samples.

© DUPONT

**Tensolite**

INSULATED WIRE COMPANY, INC.  
198 MAIN STREET, TARRYTOWN, N. Y.  
PACIFIC DIV.: 1516 N. GARDNER ST., LOS ANGELES, CALIF.

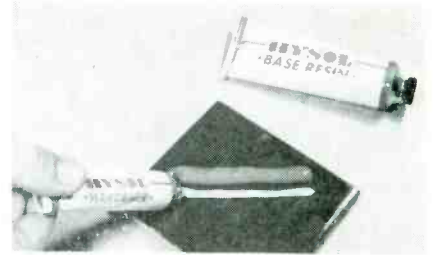

Squeezing from far end of tube insures even pressure, giving uniform thickness of each bead when dispensing resin and hardener in preparation for mixing

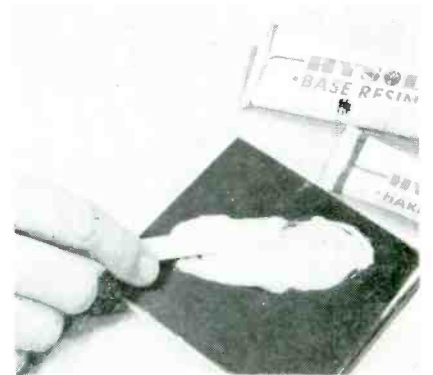

Wood blade serves equally well for mixing and applying epoxy adhesive

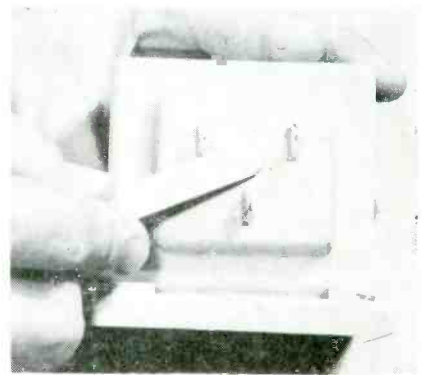

Filling void in encapsulated transformer

when a small quantity of the epoxy is needed for repair of an electronic component.

Any discardable flat surface, such as wood, cardboard or paper, can be used as a palette for mixing. The ingredients are squeezed from the tubes in parallel beads of equal length, then mixed with a spatula or a wood tongue depressor. The same tool can be used for applying the adhesive.

At room temperature, the adhesive will harden in about 1 hour and cure completely in 24 hours. At 140 F, easily achieved with heat lamps, hardening takes only ½ hour and a complete cure 1½ hours.

The ability of the Bakelite epoxy

Accurate grid alignment, stability under sustained vibration assured by ceramic pin which anchors grids to cathode can.

Bar type screen grid gives lower feed-through capacitance and improved thermal performance.

Integral finned cooler, furnace brazed to external anode for high thermal efficiency.

Eimac stacked-ceramic construction throughout for mechanical strength, higher temperature processing, better thermal conductivity and superior electrical efficiency at VHF and high temperatures.

Mechanically rugged, high efficiency, indirectly-heated, oxide-coated cathode.

Conical and cylindrical die-formed tube element supports for mechanical strength, precise element alignment and good heat dissipation.

Breechlock-type base for large contact area, firm tube support.



## New 1000 watt ceramic tetrode for SSB... the EIMAC 4CX1000A

Eimac fills another important transmitting need with this air-cooled, ceramic-metal, one-kilowatt tetrode... the 4CX1000A. Specifically designed for single side band operation the 4CX1000A is a low-voltage, high-current Class AB<sub>1</sub> RF or AF linear amplifier tube, exhibiting high power gain and exceptionally low distortion characteristics. The 4CX1000A achieves its maximum rated output power with zero grid drive, thus minimizing driver stage design problems and eliminating one source of distortion.

Eimac stacked ceramic design gives the 4CX1000A excellent immunity to damage by mechanical and thermal shock. Electrical stability is assured by internal ceramic support of the tube elements and clean internal

design. Ideal for applications where space is at a premium, this mechanically-rugged, electrically-reliable thousand watt tetrode measures less than 5 inches high and 3½ inches in diameter. High temperature processing, made possible by Eimac ceramic-metal design, produces an extremely clean tube. This ideal environment assures long life for the efficient oxide-coated cathode.

Efficient, trouble-free socketing and cooling is provided for the 4CX1000A by the new SK-800 Air System Socket and SK-806 Chimney.

Write our Application Engineering Department for a brochure and data sheet describing this important new tube in detail.

**EITEL-McCULLOUGH, INC.**

SAN BRUNO · CALIFORNIA

*Eimac First for quality, dependability and performance*



### MAXIMUM RATINGS (Per Tube)

DC Plate Voltage	3000 Volts Max.	Plate Dissipation	1000 Watts Max.
DC Screen Voltage	350 Volts Max.	Screen Dissipation	12 Watts Max.
DC Plate Current	1.0 Amps Max.	Grid Dissipation	0 Watts Max.

### TYPICAL OPERATION SINGLE-TONE SSB

DC Plate Voltage	2500 Volts	DC Plate Current	1.0 Amps	Actual Power Output	1460 Watts
------------------	------------	------------------	----------	---------------------	------------

# DAYSTROM INSTRUMENT WILL DESIGN AND BUILD YOUR SPECIAL TEST EQUIPMENT

We Have the Engineers and Facilities For  
RESEARCH, DEVELOPMENT and PRODUCTION



Our highly skilled research and development engineers are expert in defining, executing and overseeing test equipment projects. We are delivering test equipment of a highly specialized nature for both military and commercial applications.



Add to this Daystrom's ability to supply pilot runs to prove such designs . . . and a complete facility for volume production, and you'll understand why, MORE AND MORE, the Armed Services and industry are turning to Daystrom Instrument.

Consider Daystrom when you have test equipment requirements which must meet the most critical standards.



## DAYSTROM INSTRUMENT

*Division of Daystrom Inc.*

**Archbald, Pennsylvania**

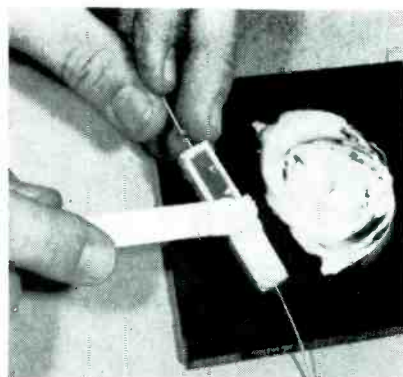

Sealing component in ceramic housing



Filling holes in plastic molds. After adhesive is cured, repair can be sanded, smoothed and buffed to gloss finish

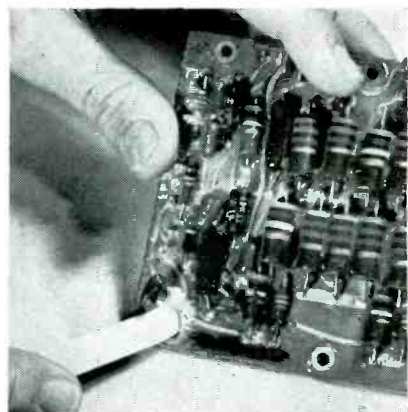

Applying adhesive over repaired portion of printed wiring board to restore protective moisture-sealing coat. For broken board, small patch of glass cloth would be used over surface to improve mechanical strength of bond

resin to wet and adhere to both metallic and nonmetallic surfaces makes this kit practically universal in application in the electronic field. The only requirement is that the surfaces to be filled or joined are completely clean and dry. It can thus be used for filling cavities in plastic or metal objects, repairing flaws in encapsulated compon-

# R-B-M Miniature Multipole Relays of Proven Reliability

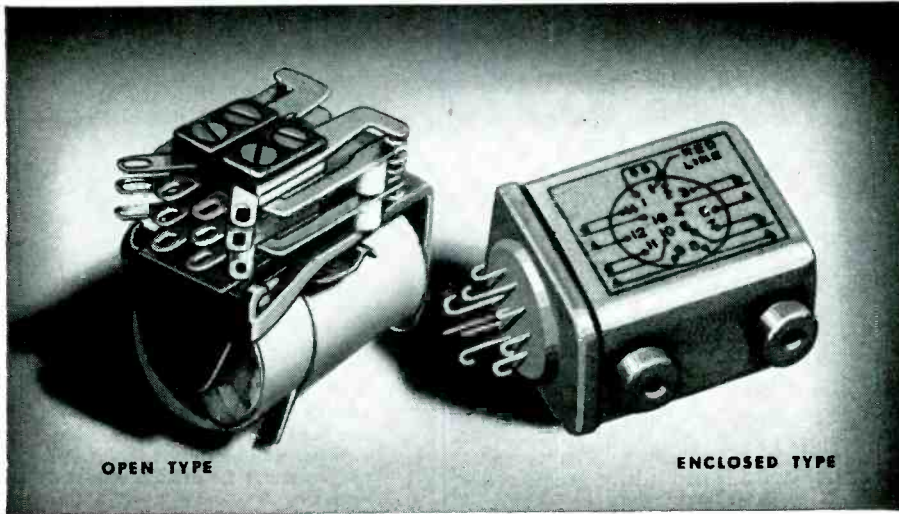

OPEN TYPE

ENCLOSED TYPE

*Light weight, Small Size Open and Hermetically Sealed Types for Electronic and Communication Application*

**APPLICATION:** R-B-M Miniature Multipole Relays are used where the prime factors in switching electronic circuits are small size, light weight and reliability. These proven designs are produced for switching low power circuits, low capacitance circuits and power circuits. 125° C insulation now available on some versions. Coils can also be designed for plate circuit.

**CONSTRUCTION:**

**Magnet Frame**—Four sizes available on open type relays and three sizes on hermetically sealed type.

**Contacts**—Cross-bar palladium welded to nickel silver springs or button contacts on Beryllium copper springs.

**Terminals and Mountings**—Glass headers provided with either solder or plug-in type terminals with many various types of mountings available. Octal type plug-in headers can be provided on the HL enclosure. Plug-in terminals to fit either 9 or 14 pin standard sockets. Maximum of 14 pins for solder connections.

**TYPICAL SPECIFICATIONS\***

Open	Maximum Coil Resistance (OHMS)	Minimum Power Requirements Per pole at 25° C (WATTS)	Maximum Contact Form With rated current at 32 V.D.C. or 115 V.A.C. (non-inductive load)	Maximum Coil Watts	Enclosed
SM	9,000	.2	4 PDT 5 Amps. or 3 Amps. 6 PST 3 Amps.	3.75	HSM
SMD-2	9,000	1.0	SPNO Parallel Contacts Make 80 Amps. Break 20 Amps. at 32 V.D.C.	3.75	HSMD-2
SC	18,500	.16	4 PDT 5 Amps. or 3 Amps. 6 PST 3 Amps.	4.5	HPSC
SA	18,500	.14	4 PDT 5 Amps. or 3 Amps. 6 PST 3 Amps.	4.5	HLSA
SM-RF	9,000	.2	SPNO, SPDT, DPNC, SPNC, DPNO	3.75	HSM-RF HLSM-RF
SAD-2	18,500	1.0	SPNO Parallel Contacts. Make 80 Amps. Break 20 Amps. at 32 V.D.C.	4.5	HLSAD-2

\*Other ratings and specifications available.

For additional information write for Bulletin No. 1050



## RBM DIVISION

Manufacturers of Magnetic Controls and Devices / LOGANSPORT, INDIANA

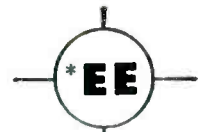

other outstanding  
**\*ESSEX ENGINEERED**  
production proven products

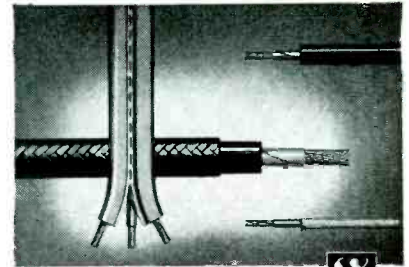

**WIRE AND CABLE**

A full "Extra Test" line of lead, appliance, automotive and refrigeration wires, plus submersible pump cable and 200° C. Sil-X insulations are examples of the versatility of "Essex Engineering".

Wire and Cable Division  
Fort Wayne, Ind.

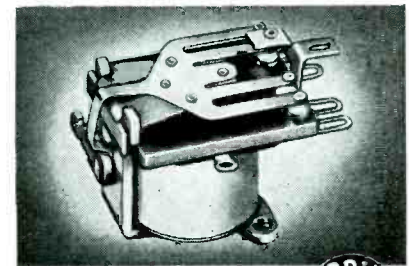

**MINIATURE RELAYS**

The Type MS Miniature Sensitive Relay is ideal for any application requiring a compact, highly reliable single pole D. C. device, where a low cost solution is required because of volume usage and competitive problems. Request Bulletin No. MS-1.

R-B-M "Control" Division  
Logansport, Ind.

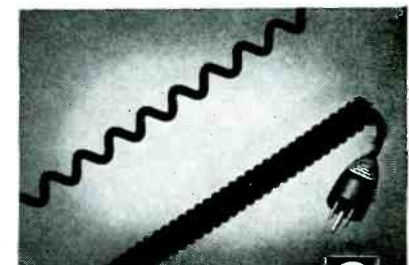

**COILED CORDS**

The "spring" in Coiled Cords automatically synchronizes with moving components that are electrically powered. There are no looping, tangling cords in the way... because Coiled Cords extend and retract as needed. Write for new literature.

Cords Limited Division  
DeKalb, Ill.



**ESSEX**  
WIRE CORPORATION

# Reliable Electrical Connections

by R. George Roesch

## Eliminate Manual Operations for Uniformity

The efficiency of many manual wire-processing operations may now appear to be perfect for the specific jobs for which they are used. The actual efficiency, however, is limited by the manual operations. It is impossible for anyone to do something time after time, exactly the same way. Honest human effort can result in some errors.

### Mechanized Wire Processing

One logical way of attaining practical quality control of wire processing—has proved to be mechanized Wire Processing Equipment developed for the specific job.

Assuming uniformity of product up to the Wire Processing Equipment, such mechanical processing can result in uniform high quality every time.

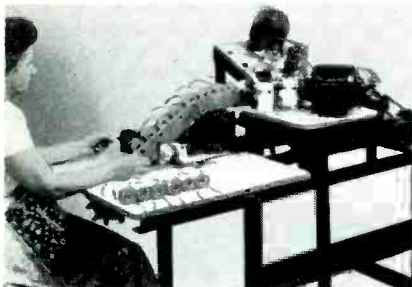

A typical example is this mechanized wire cutter and stripper designed for shunt coils wound with AWG No. 30 Formvar-insulated wire. Except for hand loading, the operation is completely automatic, at the rate of 1,620 coils per hour with one operator.

If you have a production wire-processing job, we would like to discuss it with you.

### THE ERASER CO., INC.

1068 S. Clinton St., Syracuse 4, N. Y.

#### REPRESENTATIVES:

There are still a few choice territories open, offering unusual opportunities for service and profit. Write R. George Roesch.

### PRODUCTION TECHNIQUES

(continued)

ents, resealing printed wiring boards after replacement of a component, and repair of broken ceramic, glass, aluminum, ferrous metal and wood pieces as well as most plastics and most types of hard rubber. The two-tube kit as marketed by Houghton Labs., Inc., Olean, N. Y. is particularly useful where only a very small amount of adhesive is needed at a time.

## Hard Anodizing Gives Insulation on Aluminum

USE OF HARD ANODIZING for insulating an aluminum chassis permits direct mounting of power transistors or power rectifiers to utilize the full heat-sink ability of the chassis, while providing required insulation. Dielectric tests at 500 volts indicate a resistance of several thousand megohms, which is more than adequate for existing or proposed power circuitry.

The new hard anodizing process, developed by Hughes Aircraft Co.



Finished aluminum chassis which has been hard-anodized to give insulating surface. Bare metal is left exposed in strips on sides for grounding purposes

in conjunction with Anachrome Corp., South Gate, Calif., is an adaptation of the versatile Hardas process which is applicable to any aluminum alloy chassis. Dimensional changes are minute, because the insulation is provided by a thin film of aluminum oxide formed on the surface by chemical action.

The self-insulating chassis eliminates the need for mica washers or other heat-blocking insulators between transistor and chassis when isolation is required. The resulting near-maximum transfer of heat to the chassis greatly increases the efficiency of transistor and rectifier circuits.

## When to specify VULCAN ELECTRIC STRIP HEATERS

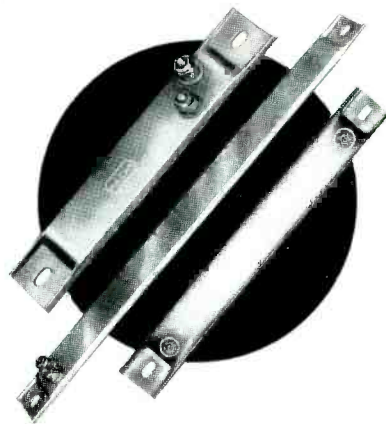

1. When application is for: Contact heating of dies, platens, molds, or any items with flat surfaces to which elements may be clamped. Also air heating source for ovens, air ducts, dryers.
2. When specifications call for: Seamless one-piece sheath; rugged non-oxidizing terminal posts; steel sheath for sheath temperatures to 750°F; Chromalloy sheath for sheath temperatures to 1200°F; 8" to 42½" lengths (or longer); 150 to 1500 watts (or higher).
3. When you have "hot" problems: Vulcan Engineers are ready to supply special heating units — engineered to your needs.

## VULCAN ELECTRIC BAND HEATERS



Constructed basically like the strip heaters, Vulcan Electric Band Heaters are designed for clamping around tanks, pipes, injection heads, etc. Standard width is 1½"; inside diameters from 6" to 15" (special smaller or larger sizes available). Semi or full circular bands. Equipped with mounting tabs or clamping bands.

Write for free catalog.



### ELECTRIC COMPANY

DANVERS 10, MASS.

Cartridge • Strip • Tubular • Immersion Electric Heaters  
• Soldering and Branding Irons  
Solder and Glue Pots

CIRCLE 142 READERS SERVICE CARD

December 1, 1957 — ELECTRONICS

CIRCLE 141 READERS SERVICE CARD



## NEWS ABOUT SILICON DEVICES

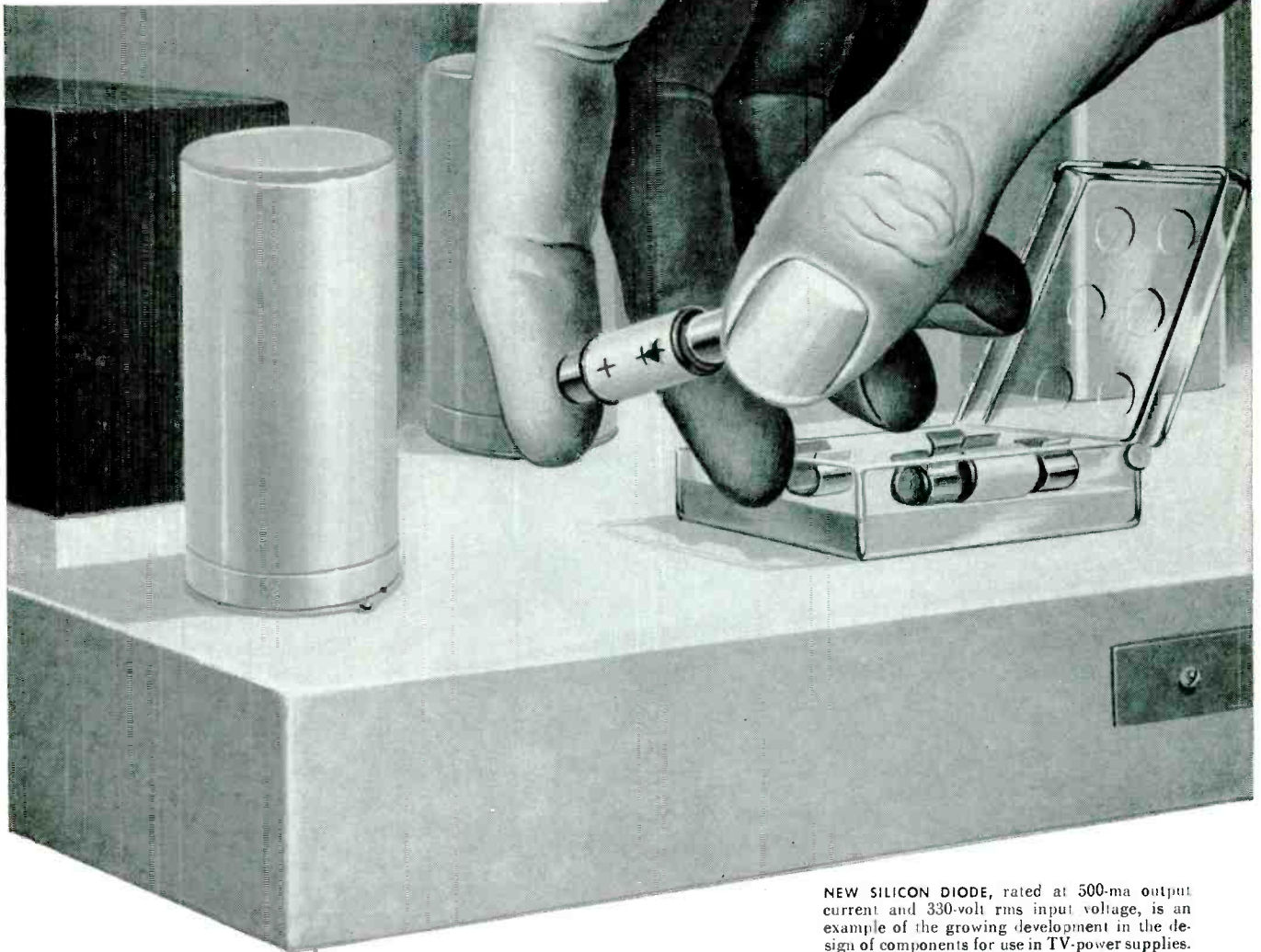

NEW SILICON DIODE, rated at 500-ma output current and 330-volt rms input voltage, is an example of the growing development in the design of components for use in TV-power supplies.

## Now... more efficient power supplies for radio-TV made possible with Du Pont Hyperpure Silicon

Actual test results as reported by various manufacturers indicate important advantages of silicon diodes and rectifiers. One TV manufacturer, for example, operated samples of silicon rectifiers under load continuously for 5,000 hours—with no noticeable drop in output voltage. Another manufacturer reports no voltage change after 500 hours in 95% humidity.

**Silicon-equipped sets** are relatively free of a decline in B+ voltage. Silicon diodes are up to 99% efficient in units operated at 60 cps—reverse leakage is as low as a few microamperes. Both rectifiers and transistors of silicon have temperature ratings far higher than those of other semiconducting materials... can operate continuously at  $-65^{\circ}$  to  $200^{\circ}\text{C}$ .

**Note to device manufacturers:** You can produce silicon transistors, rectifiers and diodes of the highest quality with Du Pont Hyperpure Silicon. It's now available in three grades for maximum efficiency and ease of use... having a purity range of 3 to 11 atoms of boron per billion. Technical information is available on crystal growing from Du Pont... pioneer producer of semiconductor-grade silicon.



### NEW BOOKLET ON DUPONT HYPERPURE SILICON

You'll find our new, illustrated booklet about Hyperpure Silicon helpful and interesting—it describes the manufacture, properties and uses of Du Pont Hyperpure Silicon. For your copy write to: E. I. du Pont de Nemours & Co. (Inc.), Silicon N-2496-E-12, Wilmington 98, Dela. (This offer is limited to U.S. and Canada.)

### PIGMENTS DEPARTMENT



REG. U.S. PAT. OFF.

BETTER THINGS FOR BETTER LIVING  
...THROUGH CHEMISTRY

# New Products

Edited by WILLIAM P. O'BRIEN

93 New Products and Latest Manufacturers' Bulletins Are Reviewed . . . Control, Testing and Measuring Equipment Described and Illustrated . . . Recent Tubes and Components Are Covered

## POWER SUPPLY

completely transistorized

MANDREL INDUSTRIAL INSTRUMENTS, Division of Mandrel Industries, 5134 Glenmont Drive, Houston, Texas. The PV-2 inverter is a completely transistorized power supply designed to operate 50 or 60 cps synchronous motors from a 12 v d-c source. It is tuning fork controlled and capable of operating motors rated up to 140 va input.

Output waveform is a modified square wave ideally suited for

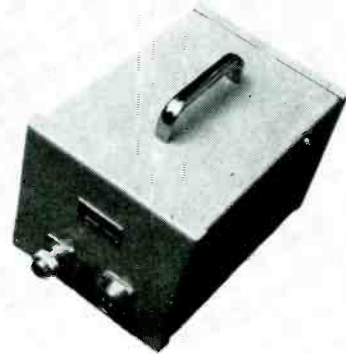

driving synchronous motors. The output voltage frequency is accurate to 0.01 percent and stable to 0.01 percent. Its magnitude is adjustable in steps to yield 115 v rms of the 50 or 60 cps component of the modified square wave output. Input current varies from 2 amperes no load to approximately 12 amperes full load. The input voltage may vary from 10.5 to 13.0 v with no deleterious effect.

Complete warm-up time is 30 sec. Overall size is 7½ in. by 6¼ in. Price is \$750. **Circle 401 on Reader Service Card.**

## MINIATURE CAPACITOR

flat or round

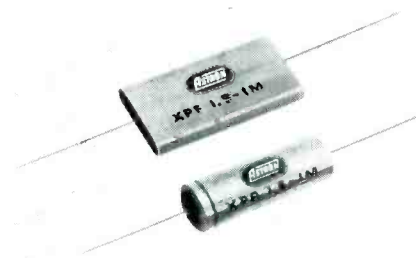

ASTRON CORP., 255 Grant Ave., East Newark, N. J. A new miniature Mylar dielectric capacitor is now available in production quantities. The new capacitors, type XPR and XPF, are designed for applications requiring minimum size, high insulation resistance and exceptional capacitance sta-

bility. A Mylar polyester outer wrap affords good protection against moisture, its ends being sealed with a plastic thermosetting resin. Voltage rating is 150 v at 85 C, 100 v at 125 C.

Reliable performance is achieved over the entire operating temperature range of -55 C to +125 C. The new series is available in flat and round construction. **Circle 402 on Reader Service Card.**

## TINY RESISTORS

carbon film types

MEPCO, INC., Morristown, N. J., has announced microminiature carbon film resistors. Resistance range is 5 ohms to 100,000 ohms. Wattage is 0.1 w at 70 C. Type C-1H is sealed in a ceramic case for protection against humidity and damage in installation. It meets requirements of MIL-R-10509B, characteristic B. Length is ¾ in. and diameter ⅜ in. Type C1 is resin

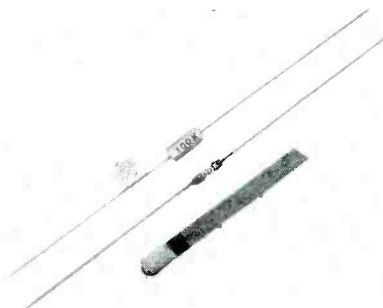

coated. Resistor is not damaged when potted in epoxy resins. It meets requirements of MIL-R-10509B, characteristic X. Length is ¾ in. and diameter ⅜ in. **Circle 403 on Reader Service Card.**

## AUDIO OSCILLATOR

with wide frequency range

WAVEFORMS, INC., 333 Sixth Ave., New York 14, N. Y., has developed



# our leadership protects yours...

It takes a lot of doing to produce the exact same thing over and over again hundreds of thousands of times—without slipping up on a thousandth of an inch, watt, or milligram. This insistence on *uniformity* has helped build our reputation as the world's most Consistently Dependable producer of CAPACITORS. Continuously uniform production is a science—one that we've painstakingly pursued since 1910.

Typical of the "countless" C-D electrolytics used by major equipment manufacturers the world over are:

**"EC" MINIATURIZED CERAMIC CASED TUBULARS** For cramped-space applications in hearing aids, transistorized devices, and remote control assemblies. Less than  $\frac{1}{4}$ " D., only  $\frac{3}{4}$ " L.

**"NL" ULTRA-SMALL** Hermetically sealed aluminum cased electrolytics, built for compactness, ruggedness, low leakage, long shelf and in-use life.

**TANTALUM 3** tubular types, all with low power-factor, moisture-impervious hermetic seal, long service and especially long shelf life. "TX" with sintered anode; "TAN" miniature foil type; sub-miniature, low-voltage wire anode type "NT".

**TYPE "UP"** Made in the smallest tubular aluminum cans possible for any given capacity and voltage combination. In single, dual, triple and quadruple capacity combinations.

Write for catalog to Cornell-Dubilier Electric Corporation, South Plainfield, New Jersey.



CONSISTENT HI-DEPENDABILITY  
**CORNELL-DUBILIER CAPACITORS**

SOUTH PLAINFIELD, N. J.; NEW BEDFORD, WORCESTER & CAMBRIDGE, MASS.; PROVIDENCE & HOPE VALLEY, R. I.; INDIANAPOLIS, IND.; SANFORD, FUGUAY SPRINGS & VARINA, N. C.; VENICE, CALIF.; & SUB.: THE RADIACT CORP., CLEVELAND, OHIO; CORNELL-DUBILIER ELECTRIC INTERNATIONAL, N. Y.

the 401A general purpose audio oscillator. The instrument features extended range (10 cps-100 kc), high output (20 v or  $\frac{1}{2}$  w), purity of signal ( $\frac{1}{4}$  percent distortion for all conditions) and a flex-

ible attenuator system.

The unit utilizes a new oscillator circuit to achieve low distortion and freedom from switching and tuning transients. This new oscillator circuit, together with

novel output amplifier circuitry, provides overall instrument performance heretofore available only in instruments of greater complexity and costs. **Circle 404 on Reader Service Card.**

## SELENIUM DIODE

for computer applications

BRADLEY LABORATORIES, INC., New Haven, Conn., is producing a new selenium diode, designed especially for computer applications.

First use of the unit, designated SP1M4H867, was as a replacement for a germanium diode in which considerable difficulty was en-

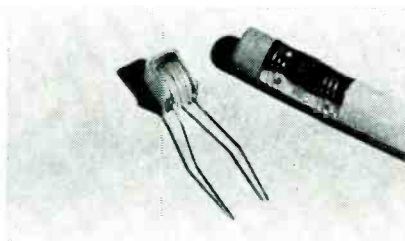

countered because of random surges of pulses. One of the inherent advantages of selenium is its ability to withstand overload.

Specifications of the selenium diode are: 50 ma intermittent duty, 12 milliseconds on; 5 ma continuous duty; and peak inverse voltage of 150 v. Clip-type housing measures  $\frac{1}{4}$  in. by  $\frac{1}{8}$  in. by  $\frac{3}{32}$  in. **Circle 405 on Reader Service Card.**

## VANE TRANSDUCER

local angle of attack type



G. M. GIANNINI & Co., INC., 918 East Green St., Pasadena 1, Calif. A new local angle of attack transducer that conforms to MIL-T-25627 (USAF) has been added to the company's line of vane transducers. This unit, model 2562, provides accurate angle of attack information at all speeds and altitudes throughout a wide operational range.

This instrument consists of a heated, split-wedge vane, geared

to two output synchros. Damping is maintained at 0.5 of critical by a uniquely simple viscous-type damping mechanism. Recovery time for 63 percent of a step input at 110 knots is only 0.075 sec, and sensitivity is 0.2 deg from 90 knots to 125 knots and 0.1 deg from 125 knots to Mach 3.0.

Specifically designed to meet or exceed the requirements of MIL-T-25627, this transducer is ideal for operational or flight-test applications requiring accurate angle of attack or side slip information. **Circle 406 on Reader Service Card.**

## D-C MILLIVOLTMETER

and d-c amplifier

INDUSTRIAL CONTROL Co., 805 Albin Ave., Lindenhurst, L. I., N. Y. The 216A is an extremely sensitive, direct reading, d-c millivoltmeter and d-c amplifier. It features a zero center indication with  $\pm 1$  mv d-c full scale, and a zero point so stable that no zeroing control is provided. Maximum amplifier gain is 1,000, input impedance 2 megohms, and full scale sensitivities range from 1 mv to 10 v d-c in 9 overlapping ranges.

The 216A is designed for rack-mounting, is ruggedized for military usage and is built to MIL-T-945A. Panel dimensions are 19 by

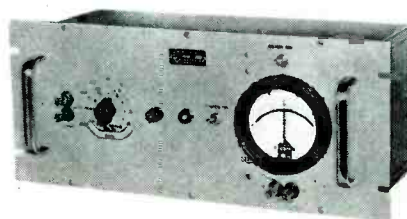

8 in. and depth behind the panel is 8 in.

The unit has been designed especially for military ground support equipment. It is also recommended

wherever a rugged, reliable and sensitive millivoltmeter and amplifier are required. **Circle 407 on Reader Service Card.**

## COUNTER

has two predeterminations

PRESIN Co., 12128 W. Pico Blvd., Los Angeles 64, Calif. Specifically designed for winding tapped coils, the model U280Z has two predeterminations, each independently settable to a total of 99,999, one for the tap and one for the final with knockoff by spdt switches. The counters add and subtract to

# Now in production revolutionary WEDGE ACTION RELAY!

MARK II RELAY

## Specifications:

Operating Vibration ... 5 to 2000 cps, 30 G's  
Contact Rating ... Dry Circuit to 2 amps  
Contact Arrangement ... 6 pole double throw  
Ambient Temperature ... -65°C. to +200°C.  
Contact Bounce ... None  
Operating Shock ... 100 G's

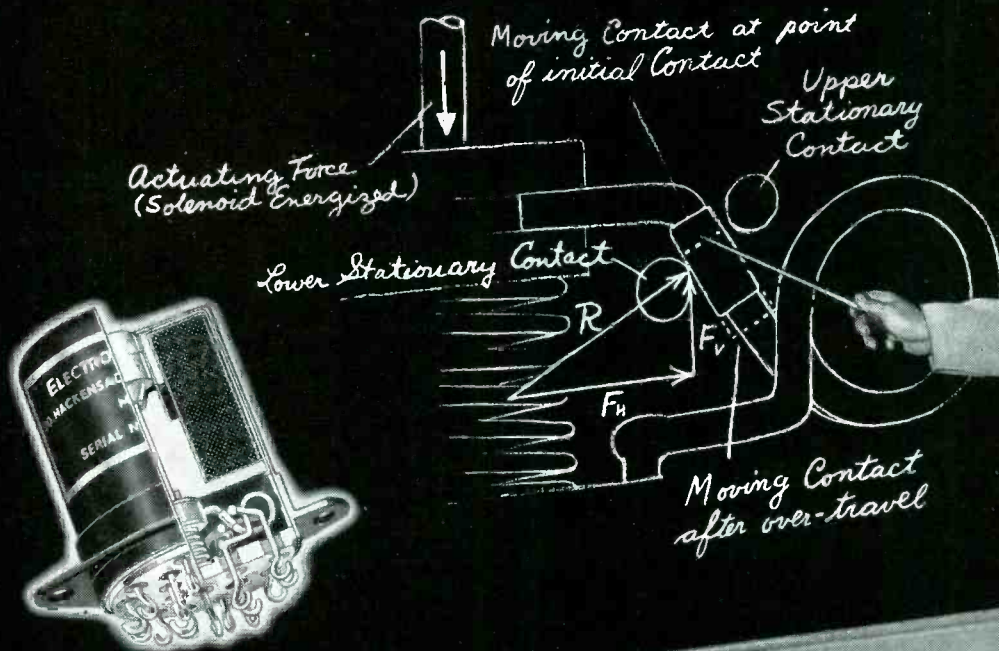

**MARK II RELAY** provides **ULTRA-RELIABILITY** under the most extreme environmental and operating conditions.

**NOVEL WEDGE ACTION SWITCHING** provides positive contact in both energized and de-energized conditions.

Contact pressure constantly increases during over-travel.

Wedge Action now supersedes "Wiping Action".

- Removes contaminants from contact surfaces.
- Reduces resistance to micro-level currents.
- Renders relay extremely resistant to shock and vibration.

**BRIEF DESCRIPTION:** Six pole. Double-throw. Miniature unit. Hermetically sealed. Meets—and *exceeds*—specifications MIL-R-5757C and MIL-R-25018.

From an organization of recognized authority in advanced instrument design—Electro Tec—comes, not merely another new relay, but a *completely new concept* in ultra-precision relay operation.

This new Mark II Wedge Action relay—now in production—offers designers of ultra-reliable electronic equipment immediate and outstandingly high performance, amply proven under the most extreme environmental and operational conditions. *Designers should write—or wire for additional information.*

*Products of Precision Craftsmanship*

**ELECTRO TEC CORP.**

South Hackensack, N. J.



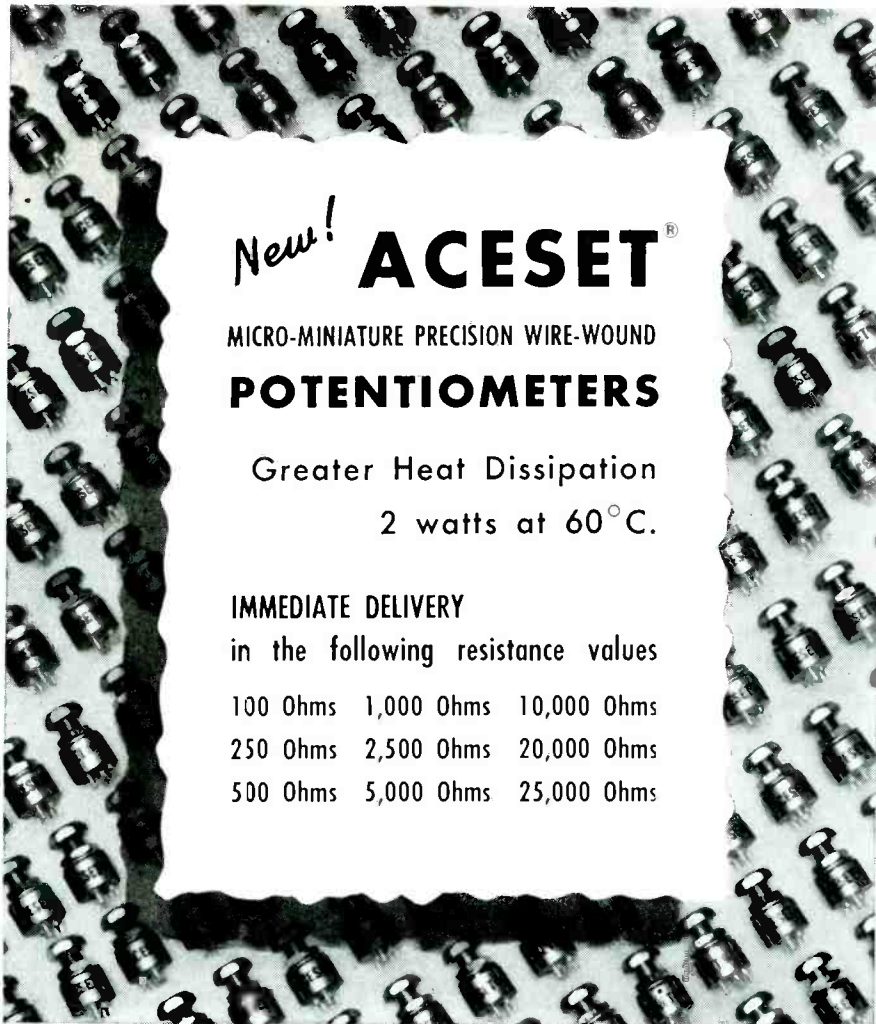

## New! ACESET<sup>®</sup>

### MICRO-MINIATURE PRECISION WIRE-WOUND POTENTIOMETERS

Greater Heat Dissipation  
2 watts at 60°C.

#### IMMEDIATE DELIVERY

in the following resistance values

100 Ohms	1,000 Ohms	10,000 Ohms
250 Ohms	2,500 Ohms	20,000 Ohms
500 Ohms	5,000 Ohms	25,000 Ohms

ACESETS shown approx. 1/2 size

Now you can select from nine different resistance values and improve the accuracy and dependability of your circuit performance. ACESET precision, wire-wound, micro-miniature potentiometers offer greater stability under temperature cycling through the use of 20 ppm temperature coefficient wire. Improved performance at lower costs have been achieved by mass producing to standard specifications. Shipments are guaranteed within 24 hours of receipt of order. Call, wire or teletype Dept. F at Ace Electronics Associates, Inc., 99 Dover Street, Somerville, Mass. SOMerset 6-5130. TWX SMVL 181

#### MECHANICAL SPECIFICATIONS

One piece precision-machined metal case  
Passivated stainless steel shaft  
Self-contained locking device  
Panel anti-rotation pin  
Mechanical rotation: 330° nominal  
Size: 1/2" diameter x 3/16" body length

#### ELECTRICAL SPECIFICATIONS

Heat Dissipation: 2 watts at 60°C.  
Voltage breakdown: 1,000 VDC  
Electrical Angle: 325° nominal  
Temperature coefficient of wire: 20 ppm  
Resistance tolerance: ±10%  
Linearity: ±5%

**ACE** ELECTRONICS ASSOCIATES, INC.

ACEPOT<sup>®</sup>

ACETRIM\*

ACEOHM<sup>®</sup>

\*TRADEMARK APPLIED FOR  
ACESET<sup>®</sup>

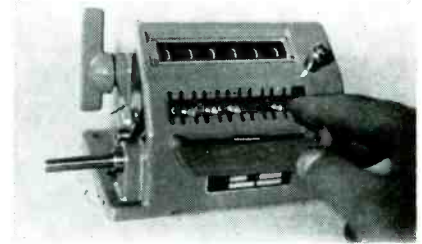

a maximum speed of 5,000 rpm. The double presetting is quickly and easily accomplished by means of grip wheels under the hinged cover. Both predeterminations are simultaneously reset to zero for repeat cycling by quick lever or automatically by motor.

The counter is available with optional 8-digit key reset totalizer, or for electrical counting for base and panel mounting. Among other applications for the counters are processes requiring a warning or deceleration signal. **Circle 408 on Reader Service Card.**



#### ALL-METAL MOUNTING for airborne equipment

ROBINSON AVIATION, INC., Teterboro Air Terminal, Teterboro, N. J., has developed a low frequency all-metal unit mounting to mount airborne resolvers, computers and radar search equipment. The natural frequency of model 1459 is between 5 and 9 cps for vibration protection. Vibration isolation response at 30 cps, for example, is as high as 90 percent and improves at higher frequencies. Met-L-Flex resilient elements incorporated in the design provide the environmental control of shock impacts and superimposed vibratory forces. These mountings possess a high percentage of inherent damping for longer equipment life under severe conditions.

Model 1459 is designed to ac-



## Now—the first 155°C (Class F) polyester film-coated magnet wire designed to meet new AIEE requirements

*Another Anaconda first!* Anatherm—a new polyester film-coated magnet wire—fully tested for use at “hottest-spot” temperatures up to 155°C. With this new higher level of thermal stability, Anaconda Anatherm is the first film-coated wire to meet the newly adopted AIEE 155°C (Class F) rating!

Greater thermal stability—plus excellent abrasion-resistance characteristics, chemical stability and dielectric strength—makes Anatherm ideally suited for manufacturers seeking maximum performance and reliability from smaller and smaller equipment operating at higher and higher temperatures.

As a polyester magnet wire, Anatherm can be used equally successfully at any hottest-spot temperature over the range of 105°C to 155°C.

Available in single and heavy film thickness in AWG sizes from 15 through 25.



FREE TECHNICAL BULLETIN on Anatherm Magnet Wire is available. Simply write: Anaconda Wire & Cable Company, 25 Broadway, New York 4, New York.

67374



ASK THE MAN FROM **ANACONDA**<sup>®</sup>  
ABOUT **ANATHERM MAGNET WIRE**  
CIRCLE 167 READERS SERVICE CARD

# HIGH VOLTAGE QUALITY RELIABILITY

**50 KV  
DC  
SUPPLY**

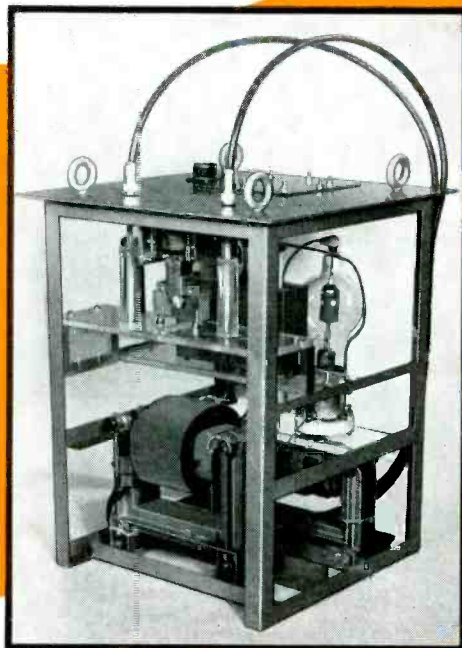

Typical of the Del high voltage oil insulated power supplies, this 50 KV unit was developed specifically for laboratory and industrial use by engineers with long experience in the high voltage field.

Controls with special features to suit your requirements can be furnished on short term delivery.

Other supplies up to 200 KV, 20 KVA, in air, oil or solid insulating media, with vacuum tube or semi-conductor rectifiers.

For additional information write to:

## SPECIFICATIONS

### ELECTRICAL:

INPUT: 110/220 volts, 50/60 cycles.  
 OUTPUT: 0-50KV DC @ 5 or 7 MA.  
 POLARITY: Either positive or negative high with one terminal at ground potential, or center ground.  
 CIRCUIT: Full wave voltage doubler.  
 RECTIFIERS: Vacuum tubes or selenium.  
 RIPPLE: 0.4% per MA.  
 INSULATING MEDIUM: Special high grade insulating oil to insure freedom from electrical noise.  
 SAFETY FEATURE: Stored energy automatically discharged from capacitors on removal of input power.

### PHYSICAL:

SIZE: 16½" x 16½" x 22½" high.  
 FINISH: Gray hammertone enamel.  
 HOUSING: Heavy gauge steel oil tight tank with four eye bolts for lifting.

### CONNECTORS:

Input — AN-3102-22-18P fastened to tank.  
 Output — Shielded polyethylene cables.

commodate loads of 16 to 23 lb per mounting. They are used in multiple units to mount airborne components requiring shock and vibration protection as set forth in military specification MIL-C-172B. Modifications for lighter or heavier load ratings may be designed upon request.

Installation requires only one ¼-20 UNC-2B bolt to attach the equipment to the mounting. Mounting to the airframe is facilitated by four 0.196 diameter holes per mounting. Self-locking devices and choice of thread size are available. Circle 409 on Reader Service Card.

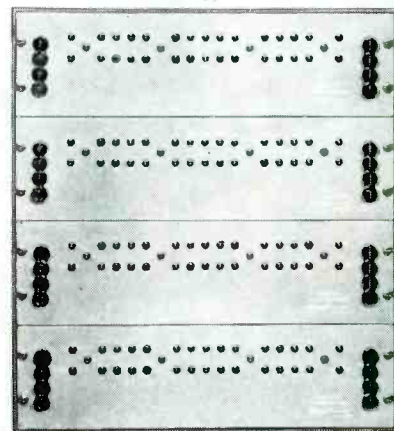

## LONG DELAY LINE has 100 external taps

EPSCO INC., 588 Commonwealth Ave., Boston 15, Mass., has manufactured a lumped constant delay line to meet the specific requirements of an auto-correlation application—complex input waveforms are to be delayed from 0 to 100 milliseconds, without any deterioration of the shape of the waveforms resulting when the maximum delay is used. The delay line has 100 external taps, permitting the delay to be selected in one-millisecond increments.

The 100-millisecc line consists of four identical 0 to 25 millisecc tapped delay lines in cascade. Each of these separate delay lines contains 25 sections of m-derived LC networks utilizing high-Q toroidal inductances and ultrastable capacitors. The precise matching of all these LC networks makes possible the successful cascading of



**DEL ELECTRONICS CORPORATION**

521 HOMESTEAD AVENUE • MOUNT VERNON, N. Y. • OWENS 9-3232

**WE DESIGN AND MANUFACTURE A VARIETY OF HIGH VOLTAGE, LOW CAPACITY FILAMENT TRANSFORMERS, REACTORS AND OTHER SPECIAL PURPOSE TRANSFORMERS.**



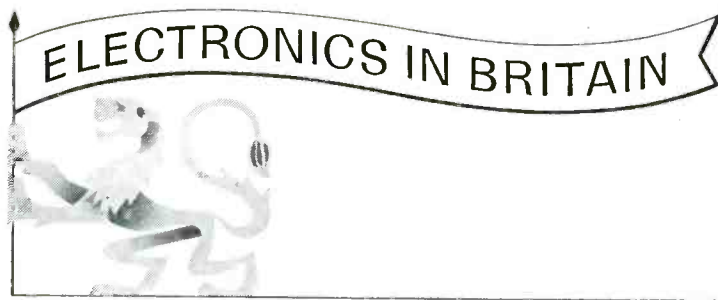

# British 25W high fidelity output tube

## builds Sound Reputation

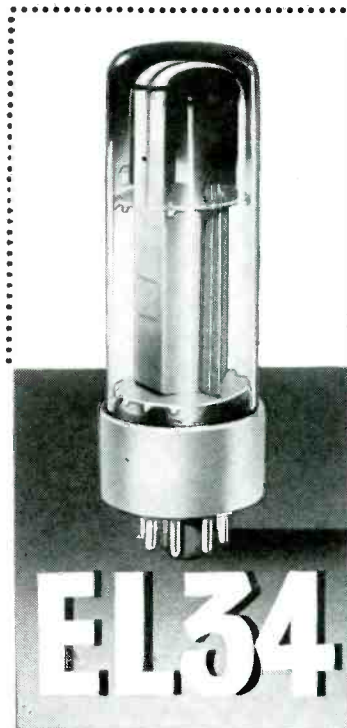

### Other Mullard hi-fi audio tubes

- EF86**     Low noise, low hum, low microphony  
6267     input tube
- EGC83**     High  $\mu$  double triode  
12AX7
- EL84**     Medium power output pentode—  
6BQ5     17 watts in push-pull
- EZ81**     Full wave, noval base, rectifier—  
6CA4     350V at 150mA
- GZ34**     Full wave rectifier—  
5AR4     450V at 250mA.

### Principal Ratings

- Heater 6.3V, 1.5A
- Max. plate voltage 800V
- Max. plate dissipation 25W
- Max. screen voltage 500V
- Max. screen dissipation 8W
- Max. cathode current 150mA

### Base

Octal 8-pin.

Second to none. This claim has been made for many products but none deserves it more than the Mullard EL34 (6CA7) high fidelity output tube. The exceptionally high efficiency of this tube has led to its adoption by the majority of equipment manufacturers in Britain, as well as an ever increasing number in America and Canada.

The facts speak for themselves. In push-pull ultra-linear operation (distributed load), two EL34 tubes under self-bias conditions will give over 40W output at a low level of distortion. Distortion may be further reduced to a very low value when negative feedback is applied.

The EL34 when used as a pentode is capable of supplying still higher power output. Under fixed-bias class B conditions, 100W is obtainable from a pair of EL34 tubes in push-pull.

A further significant feature of this tube is its high transconductance value of 11,000  $\mu$ mhos, resulting in high power sensitivity and low drive requirements.

Full details of the complete range of Mullard hi-fidelity audio tubes may be obtained from either of the distributing companies mentioned.

**Mullard**  
**ELECTRONIC TUBES**  
*used throughout the world*



Mullard is the Trade Mark of Mullard Limited and is registered in most of the principal countries of the world.  
MEV 51

### Supplies available from: in the U.S.A.

International Electronics  
Corporation,  
Dept. E12, 81, Spring Street, N.Y. 12,  
New York, U.S.A.

### in Canada

Rogers Majestic Electronics Limited,  
Dept. 11, 11-19 Brentcliffe Road,  
Toronto 17,  
Ontario, Canada.

**MULLARD OVERSEAS LTD., MULLARD HOUSE, TORRINGTON PLACE, LONDON, ENGLAND**



## I Get Shortest Etching Time with **HUNT** **ETCHANTS**

### HUNT R.C.E. (Rapid Circuit Etch) FOR PRINTED CIRCUIT BOARDS

Hunt R. C. E. is a proprietary etchant, formulated to etch printed circuits fast and to speed up production. It offers these 6 big advantages:

1. 15% increase in etching speed
2. Fast action over entire circuit
3. Uniformly smooth etching
4. Easily removed by washing
5. Substantial increase in capacity
6. Freedom from fumes

### HUNT S.C.E. (Solder Circuit Etch) FOR SOLDER-PLATED CIRCUIT BOARDS

This ready-prepared product is designed to etch solder-plated circuit boards more easily, more effectively than it has ever been done before. You'll find that Hunt S. C. E..

1. Etches rapidly at room temperatures
2. Has a high capacity for copper
3. Never attacks the circuit
4. Has guaranteed uniformity, and is of the highest quality because of rigid laboratory control

Hunt S. C. E. is essentially an oxidizing solution with the capacity to keep the oxidized copper permanently in solution. Although many acids will etch copper, S. C. E. solution has the peculiar property of not attacking the solder . . . but giving fast, odorless etching of the copper.

Write to nearest Hunt Branch for:

Technical Bulletin No. 1.—  
"The Etching of Copper by Hunt  
R. C. E. Solution"

Technical Bulletin No. 3—"the  
Etching of Solder Plated Circuit  
Boards by Hunt S. C. E. Solution"

**HUNT R.C.E. SOLUTION**  
145 lb. rubber drums  
600 lb. poly drums

**HUNT S.C.E. SOLUTION**  
125 lb. carboys  
530 lb. poly drums



**PHILIP A. HUNT COMPANY**  
PALISADES PARK, N. J.

Chicago • Cleveland • Cambridge • Brooklyn • Atlanta • Dallas • Los Angeles • San Francisco

the four units—in fact, there is no reason why more than four such units could not be cascaded, thus creating an even longer delay line.

A significant design feature of the 25-millisecond lines is that their input and output sections are externally disconnectable, which means the lines can be cascaded or used separately without any internal wiring modifications. Circle 410 on Reader Service Card.



### SUBMINIATURE SWITCH toggle-actuated

UNIMAX SWITCH DIVISION, The W. L. Maxson Corp., Ives Road, Wallingford, Conn. Designed to give the advantage of single-hole panel mounting and a toggle actuator mechanism, together with subminiature size, the new USMB-1 snap-acting switch fits into back-of-panel space only 2 5/23 in. by 3/16 in. Connection terminals at the rear of the switch housing handle wires up to No. 18.

The toggle actuator can be furnished with any USM series basic switch. The USM series are rated at 2 1/2 amperes, 30 v d-c, inductive; 4 amperes 30 v d-c, resistive; and 5 amperes 125/250 v a-c. Data sheet USM-2 gives complete information. Circle 411 on Reader Service Card.

### RECTIFIERS

miniaturized, copper oxide

BRADLEY LABORATORIES, New Haven, Conn. A new line of miniaturized copper oxide instrument rectifiers is announced under the series designations of CX1A4F and CX5A4F.

Advantages are negligible error with temperature variations, long

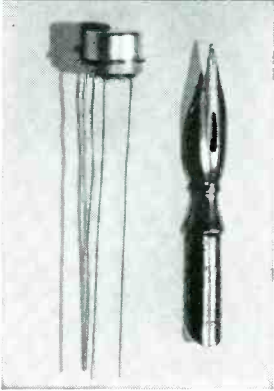
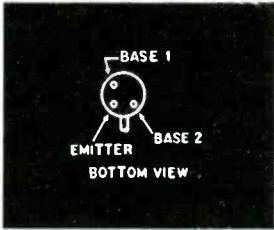

# G-E Unijunction Silicon Transistor

**NOW FULLY CHARACTERIZED AND PROVED  
FOR USE IN SIMPLIFYING CIRCUITRY**

The unique advantage of the unijunction transistor lies in its open-circuit-stable negative resistance characteristics. The unijunction is the nearest solid state equivalent to the grid-controlled thyatron and is very sensitive to voltage levels. It is primarily useful in switching and oscillator applications. Not only will one unijunction do the job of two transistors (and with less circuitry) but the circuit will be more stable over a wide temperature range.

Technical data and application ideas are available to help you in studying the unijunction—the first device other than the transistor itself to reach commercial success. The six unijunction types can be obtained from most G-E Distributors, or write *General Electric Company, Semiconductor Products Dept., Section S25127, Electronics Park, Syracuse, New York.*

## SPECIFICATIONS OF THE SIX SILICON UNIJUNCTION TYPES

### Absolute maximum ratings (25°C)

RMS power dissipation	250 mw
RMS Emitter current	50 ma
Peak emitter current	2 amps
Emitter reverse voltage	60 volts
Operating temperature range	-65°C to 150°C.
Storage temperature range	-65°C to 200°C.

### Major electrical characteristics (nominal)

	2N489	490	491	492	493	494	
Interbase resistance at 25°C junction temp.	5.6	7.5	5.6	7.5	7.5	5.6	kΩ
Intrinsic standoff ratio	.56	.56	.62	.62	.68	.68	
Modulated interbase current	12	12	12	12	12	12	ma
Emitter reverse current (T <sub>J</sub> =25°C)	.07	.07	.07	.07	.07	.07	μa
(T <sub>J</sub> =150°C)	28	28	28	28	28	28	μa

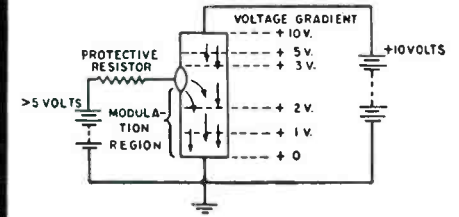
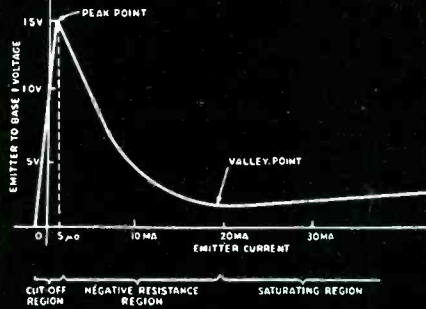

The unijunction consists of an "N" type silicon bar mounted between two ohmic base contacts, with a "P" type emitter near base 2. When the emitter is forward biased, emitter current flows, lowering the resistivity of the bar between emitter and base. Inherent regeneration results in a negative emitter to base impedance. As the emitter current increases past the valley of the curve, the conditions for inherent regeneration cease to exist. The peak point of the curve shows the beginning of the negative resistance region.

Among the many simplified circuits possible with the unijunction (cutting transistor requirements in half) are a frequency divider, matrix switching circuit, low level d-c current-sensing circuit, temperature control element, phase and/or amplitude sensitive switch. The conventional multivibrator circuit (above right) requires even more circuitry than is shown if it is to be as stable as the comparable unijunction circuit shown below. A relaxation oscillator usually takes 4 resistors, 2 transistors and a capacitor. A single unijunction, a resistor and capacitor will do the equivalent job.

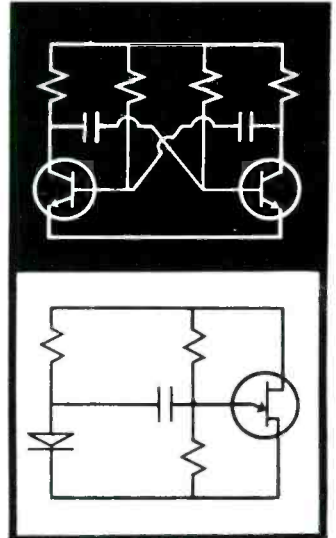

*Progress Is Our  
Most Important Product*



**GENERAL  
ELECTRIC**

# NEW

from **Potter**

no. 1  
source...

peripheral  
equipment  
for  
digital  
computers

NEW speed... NEW versatility... NEW reliability! The Potter Model 906, using transistors, offers years-ahead design and performance for every tape handling function.

## MODEL 906



**TRANSISTORIZED MAGNETIC TAPE HANDLER**

**Potter**

**POTTER INSTRUMENT COMPANY, INC.**

SUNNYSIDE BOULEVARD, PLAINVIEW, N. Y.

OVERBROOK 1-3200

### FEATURES

- Completely transistorized
- Up to 150 ips
- As many as 4 speeds forward and reverse
- Rewind or search at 400 ips
- Vacuum loop buffer
- 3 millisecond starts
- 1.5 millisecond stops
- Tape widths to 1 1/4"
- Up to 47 channels
- All functions remotely controllable
- Capable of continuous cycling at any frequency from 0 to 200 cps without flutter
- In-line threading, end of tape sensing, and tape break protection

Other Potter products include Transistorized Frequency Time Counters, Magnetic Tape Handlers, Perforated Tape Readers, High Speed Printers, Record-Playback Amplifiers and Record-Playback Heads.

WRITE, WIRE OR PHONE  
FOR SPECIFICATIONS ON THE  
MODEL 906

NEW PRODUCTS

(continued)

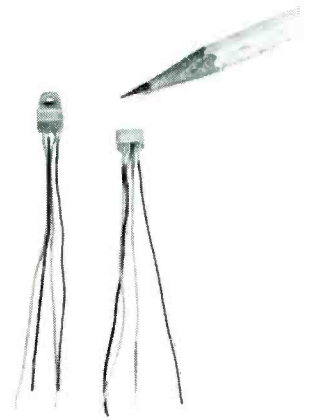

life, retention of electrical characteristics under vibration and high resistance to momentary overload. Designed for general meter and instrument application, the series also meet the specifications for VU meters.

Units consist of 4 cells in a full-wave bridge circuit. They are rated up to 2 ma d-c and 6 v a-c input, and supplied with 3-in. leads. Various types of mountings are provided to meet assembly requirements. Overall dimensions without mounting are 1/4 in. by 1/2 in. by 1/2 in. Units are moisture and fungus-resistant. **Circle 412 on Reader Service Card.**



**ULTRASONIC CLEANER**  
self-contained unit

BRANSON ULTRASONIC CORP., 40 Brown House Road, Stamford, Conn., has available a self-contained ultrasonic cleaner in a single cabinet. Including a heater, temperature control, filtration and recirculation system in addition to the ultrasonic generating equipment, model R-50 is nonetheless

# the mighty nine plus two!



New Triplet Model 630-PL

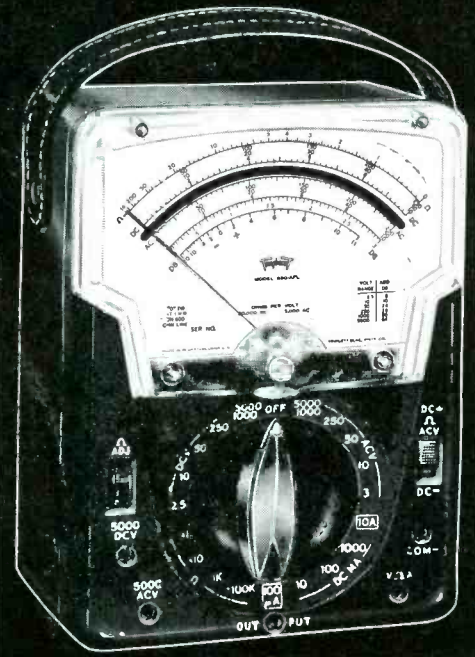

New Triplet Model 630-APL

## TWO NEW VOLT-OHM-MILLIAMMETERS

Now the Triplet Mighty Nine Has Expanded to A Line of 11 VOMs Tailored to Meet Your Preference, Purse or Purpose. Only Triplet Offers So Complete A Variety.

With the new 630-PL and 630-APL you get these important new features:

- Voltage scales for those who want ranges reading by 10's (2.5-10-50-250-1000-5000).
- Instant-vision, wider spread scales; streamlined case, handsome modern design.

- D.C. Polarity Reversing Switch.
- 5 to 500,000 Cycles per second frequency response in A.C. measurements.
- 5000 ohms per volt sensitivity in A.C. ranges; 20,000 ohms per volt D.C.

Both new testers — with the popular continued Models 630 and 630-A—offer these proved Triplet advantages:

- One switch will select any range; minimizes chance of incorrect settings and burnouts.

- Reads from .1 ohm (4.4 ohm center scale) to 100 megohms; four ranges.

- Molded circuit panel for instant component replacement.

- Models 630-APL and 630-A feature 1/2% resistors for greater accuracy; long mirrored scales to eliminate parallax in reading.

- Banana-type leads for low contact resistance at jacks.

# how do you want it?

X 3s or X 10s

Triplet Models 630 and 630-A read volts 0-3-12-60-300-1200-6000; or Triplet New Models 630-PL and 630-APL reading 2.5-10-50-250-1000-5000.

Choose your preference in range reading.

**MODEL 630-PL... Dealer Net \$44.50**  
**MODEL 630-APL... Dealer Net \$54.50**  
**MODEL 630... Dealer Net \$44.50**  
**MODEL 630-A... Dealer Net \$54.50**

Only Triplet offers 11 VOM's—a line complete enough to give you exactly what you want.



Triplet Electrical Instrument Co.  
Bluffton, Ohio

53 Years of Experience



Triplet Model 630



Burton Browne Advertising

Triplet Model 630-A

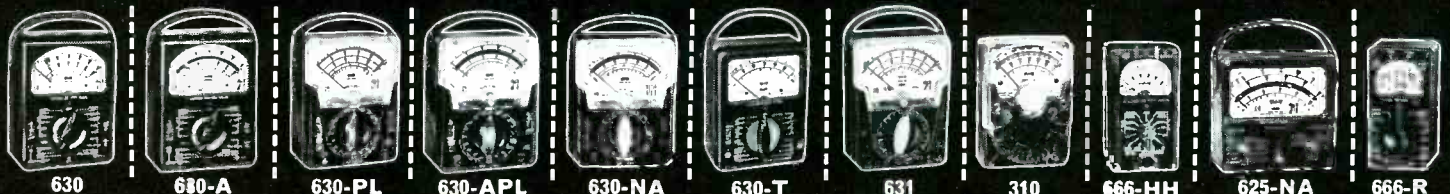

630 630-A 630-PL 630-APL 630-NA 630-T 631 310 666-HH 625-NA 666-R



# There will be more TANTALUM CAPACITORS for 1958 Deliveries

**A**s 1957...our Golden Anniversary Year...draws to a close, we look back on a year of important achievements in our continuing efforts to serve our customers better.

In the past year, we produced more tantalum—delivered more tantalum capacitors than ever before. But still the demand for more and more tantalum continues to grow.

To keep pace with this ever increasing demand, we have made the largest capital expenditures in Fansteel history for new buildings, new research laboratories, new equipment. Only a few short weeks ago, a new tantalum-columbium plant on a 113-acre tract near Muskogee, Oklahoma, started producing metal powders and ingots.

It is interesting to note that we constructed more building space in 1957 alone than the entire Company owned in 1941.

Looking ahead to 1958, we anticipate a 100% increase in capacitor grade tantalum production.

Capacitor production facilities at the Fansteel North Chicago Plant have also been increased, all of which promises production enough to meet all normal demands for tantalum capacitors.

We sincerely regret that in the past, because of the demand, it has been necessary for us to operate under self-imposed allocation procedures. However, we are confidently looking forward to serving you in 1958 with the usual Fansteel promptness in deliveries. Even now, our enlarged and improved facilities are beginning to achieve this.

Sincerely,

President

FANSTEEL METALLURGICAL CORPORATION  
NORTH CHICAGO, ILLINOIS, U. S. A.

C 578

small enough to be moved about easily. Overall dimensions are 22 by 19 by 37 in. high. Piping, pump and filter are of stainless steel with Teflon gaskets, making the unit suitable for alkaline solutions, solvents and mild acids.

The size of the tank itself is 6 by 16 by 11 in. deep, with a total working volume of 5 gallons. The transducers mounted to the bottom have a rated input of 250 r-f watt average (1 kw peak), which they convert into mechanical vibrations at 38 kc. This high-speed agitation causes cavitation in the liquid, providing a gentle but thorough scrubbing action. Even insoluble soils may be removed in minutes—sometimes seconds—and little operator attention is necessary. **Circle 413 on Reader Service Card.**



**ROTARY JOINT**  
for microwave uses

MICROWAVE ASSOCIATES, INC., Burlington, Mass. A new Ku-band rotary joint is available for use in radar and other microwave applications which require relative rotation between two waveguide members.

The MA-651 rotary joint will handle r-f peak powers close to the maximum power capability of RG-91/U waveguide. The unit may be pressurized up to 60 psig for increased r-f power handling capability. UG-419/U military standard choke flanges are used. Teflon seals keep out moisture and allow operation of the rotary joint in severe environmental conditions.

The rotary joint is fabricated from brass. Overall height from center lines of waveguide input

# Fansteel

## Silicon Rectifiers

*minimum size ... maximum performance and reliability*

rated at  
**500**

**MILLIAMPERES**  
without heat sink

rated at  
**300**  
**MILLIAMPERES**

TYPE 1A



TYPE 2A



Peak reverse voltage range 50-400 volts

Get in touch with your nearest representative ... he can help you with your specific requirements. For copy of new bulletin on Silicon Rectifiers write direct to North Chicago, Ill.

BOSTON, MASS.....	DEdham 3-0467.....	C. F. Blanchard
CHICAGO, ILLINOIS.....	TUxedo 9-3200.....	E. R. Follin, E. S. Weil
CLEARWATER, FLORIDA.....	CLearwater 3-7072.....	W. Ben Wimberly
CLEVELAND, OHIO.....	EVergreen 2-6170.....	K. E. Harvey
DALLAS, TEXAS.....	FLeetwood 2-4038.....	Dale Hjort
HOUSTON, TEXAS.....	JAckson 8-6667.....	Ralph Eads
MILWAUKEE, WIS.....	ORchard 2-4091.....	T. O. Doner
NEW YORK, NEW YORK.....	LOngacre 3-8940.....	W. E. Bullock
	CHickering 4-2268.....	Eastern Radio Corporation
PHILADELPHIA, PA.....	HAncock 4-6566.....	R. P. Fieldman
SAN CARLOS, CALIF.....	LYtell 3-8224.....	David H. Ross
SEATTLE, WASH.....	LAnder 7602.....	Avionics Liaison
SOUTH PASADENA, CALIF.....	PYramid 1-2125.....	Myrven W. Barnard
		Richard C. Martin
TUCSON, ARIZONA.....	EAst 6-5967.....	James Lockwood
TORONTO, ONTARIO.....	HUdson 8-9457.....	J. R. G. McVity



**FANSTEEL METALLURGICAL CORPORATION**  
North Chicago, Illinois, U. S. A.

E579A

**DEPENDABLE RECTIFIERS SINCE 1924**

# EAGLE

## Microflex Reset Timer

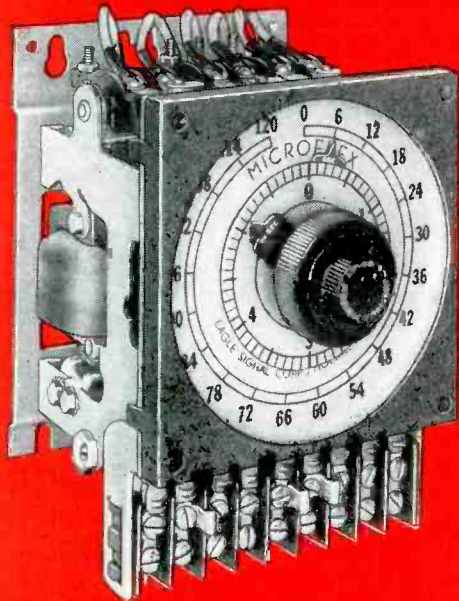

FOR  
MACHINE  
AND PROCESS  
CONTROL

### Accurate to 1 part in 1200

Time settings of pinpoint accuracy are a reality, thanks to the Microflex double dial. It takes one complete turn of the *inner* dial to advance the *outer* dial just one division. That's a 20-to-1 ratio, made possible by the patented Microflex threaded axle and pinion (see sketch). Examples of resultant accuracies are  $\pm 1/60$  of a second on a 20-second dial, and  $\pm 1/10$  of a second on a 120-second dial.

The Microflex Reset Timer is driven by a heavy-duty industrial synchronous motor. Contacts are tripped closed or open after a preset time interval. Starting and resetting are electrically controlled. Microflex offers over 150 timer operating combinations, plus a wide range of long or short time periods. It's ideal for applications like molding presses, dielectric heating, automatic mixing, die casting machines, machine tools and rubber curing.

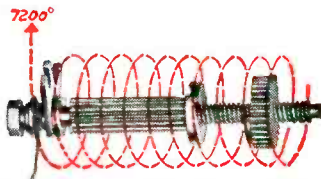

Write for free Bulletin 110.

#### MAIL COUPON TODAY

EAGLE SIGNAL CORPORATION  
Industrial Timers Division, Dept. E-1257  
MOLINE, ILLINOIS

Please send Bulletin 110 containing complete data on Microflex Reset Timers.

NAME AND TITLE \_\_\_\_\_

COMPANY \_\_\_\_\_

ADDRESS \_\_\_\_\_

CITY \_\_\_\_\_

ZONE \_\_\_\_\_

STATE \_\_\_\_\_

NEW PRODUCTS

(continued)

arms is 2.640 in. Maximum diameter is  $3\frac{1}{16}$  in. All surfaces are silver plated. External noncontacting surfaces are painted with blue-gray lacquer. Other high power rotary joints are available in the 35 kmc frequency range. Circle 414 on Reader Service Card.

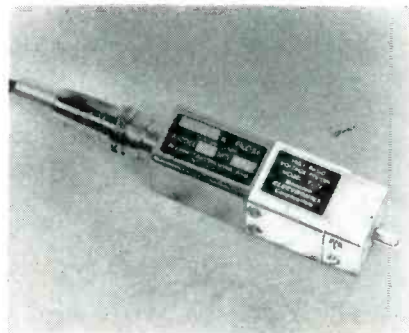

### VOLTAGE DIVIDER

100:1 step-down ratio

BOONTON ELECTRONICS CORP., 738 Speedwell Ave., Morris Plains, N. J., has developed model 91-7A voltage divider adapter for use with the model 91-B r-f voltmeter to extend its voltage range and raise its input resistance. Model 91-7A is a capacitance divider with a step-down ratio of 100:1 thus converting the 0.001 to 3 v range of the 91-B voltmeter to 0.1 to 300 v. Frequency range of the divider is 500 kc to 500 mc, with self-resonance at 900 mc.

Outstanding feature is its extremely high shunt resistance approaching 100 megohms at low frequencies and in the order of one megohm at 100 mc. Shunt capacitance is 2.5  $\mu\mu\text{f}$ . Another important feature is that the full-wave square law region of the 91-B voltmeter is thus extended permitting rms response to approximately 10 v. Circle 415 on Reader Service Card.

### DELAY LINES

lumped constant type

VALOR ELECTRONICS Co., 13214 Crenshaw Blvd., Gardena, Calif. A recently introduced group of delay lines using subminiature toroidal inductors and disk capacitors in a lumped constant con-

EAGLE TIMERS SAVE TIME . . . SAVE MONEY

**EAGLE**

SIGNAL CORPORATION  
Industrial Timers Division  
MOLINE, ILLINOIS





## How to keep informed on the “with what” part of your business

AT YOUR FINGER TIPS, issue after issue, is one of your richest veins of job information – advertising. You might call it the “with what” type – which dovetails the “how” of the editorial pages. Easy to read, talking your language, geared specifically to the betterment of your business, this is the kind of practical data which may well help you do a job quicker, better – save your company money.

Each advertiser is obviously doing his level best to give you helpful information. By showing, through the advertising pages, how his product or service can benefit *you* and *your* company, he is taking his most efficient way toward a sale.

Add up all the advertisers and you’ve got a gold mine of current, on-the-job information. Yours for the reading are a wealth of data and facts on the very latest in products, services, tools . . . product developments, materials, processes, methods.

You, too, have a big stake in the advertising pages. Read them regularly, carefully to keep job-informed on the “with what” part of your business.



**McGraw-Hill PUBLICATIONS**

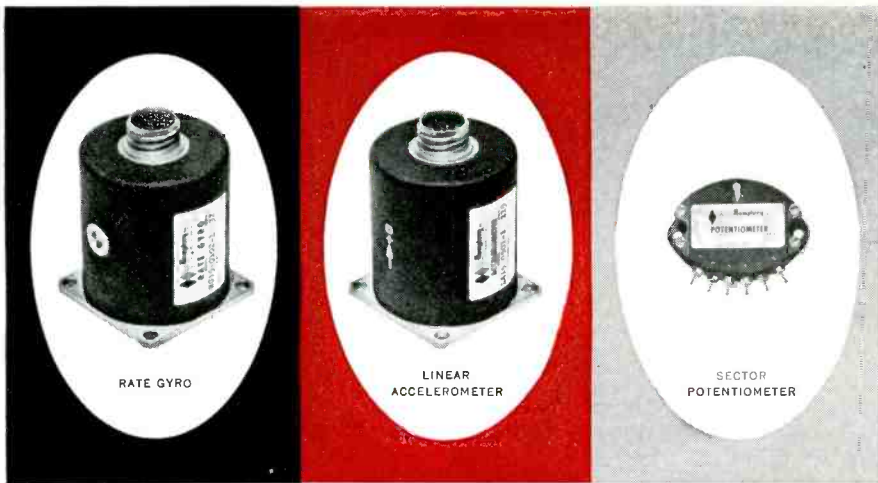

## Advanced Instrumentation by Humphrey

*New production inertial sensing instruments for extra precision and reliability*

Among the outstanding features of Humphrey's new inertial sensing instruments are: dry helium filled, hermetically sealed steel cases; standardized mountings for rate gyro and linear accelerometer; and choice of regular AN connector or new pigmy connector.

RATE GYRO is of new simplified design, with light-weight efficient motor, accurate trouble-free damping, and choice of inductive or potentiometer pick-off.

LINEAR ACCELEROMETER is of dual contra-rotating mass design. It has practically zero sensitivity to cross acceleration and angular acceleration;  $\pm$  symmetrical or asymmetrical ranges (0 to 1G) to (0 to 100G).

SECTOR POTENTIOMETER is designed for precision angle measurement in minimum space. Of all-metal construction, it is used extensively in aircraft instrumentation. Resistance element is tapped with three extra connections to provide greater circuit flexibility. Suitable for angles up to  $70^\circ$ . Standard units suitable for operations to  $350^\circ\text{F}$ .

FOR COMPLETE SYSTEMS, SPECIFY HUMPHREY GYROSCOPES, ACCELEROMETERS, POTENTIOMETERS



**Rate Gyro**—Model RG15-0102-1: New simplified design with light-weight efficient motor.



**Linear Accelerometer**—Model LA15-0501-1: Zero sensitivity to cross and angular acceleration.



**Sector Potentiometer**—Model CP01-0204-1: Cutaway photo shows rugged cast all-metal construction.

**Humphrey Inc.**  
ELECTRO-MECHANICAL INSTRUMENTS

DEPT. E-12

2805 CANON ST. • SAN DIEGO 6, CALIF.

Send full information

NAME \_\_\_\_\_

COMPANY \_\_\_\_\_

ADDRESS \_\_\_\_\_

CITY \_\_\_\_\_ STATE \_\_\_\_\_

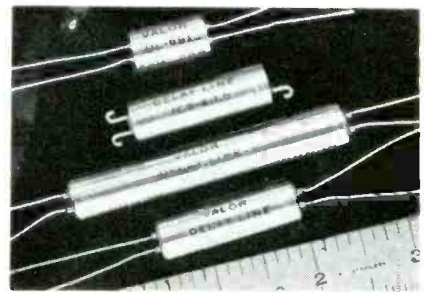

figuration make available all the superior features of lumped constant delay lines in a package size even smaller than distributed constant delay lines. Delay lines are available with from 50 to 10,000 ohm characteristic impedance, 0.1 to 10  $\mu\text{sec}$  delay, and up to 0.01  $\mu\text{sec}$  rise time.

Features of these lines include low distortion, low insertion loss and control of characteristic impedance and delay to as tight as 1 percent. Frequency and phase compensation for optimum pulse response across the pass band of the delay line is accomplished by a novel application of m-derived filter techniques.

Typical delay line examples are: the 2.5C9-3/10 packaged in a  $\frac{3}{8}$  in. metal tube one inch long having glass-to-metal end seals. This is a  $\frac{1}{4}$ - $\mu\text{sec}$  delay line having a rise time of 0.07  $\mu\text{sec}$  and a characteristic impedance of 1,000 ohms. The 5C8-7/15 is a  $\frac{1}{2}$ - $\mu\text{sec}$  delay line having a rise time of 0.07  $\mu\text{sec}$  and a characteristic impedance of 500 ohms and is packaged in a  $\frac{3}{8}$  in. diameter tube 3 in. long. **Circle 416 on Reader Service Card.**

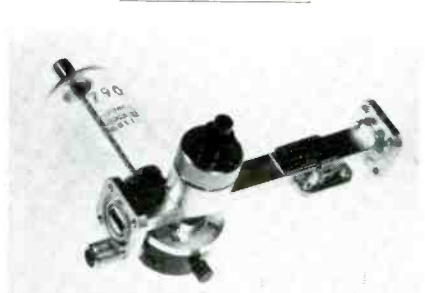

### RADAR DUPLEXER for use in the KA-band

MICROWAVE ASSOCIATES, INC., of Burlington, Mass., has developed a standard lightweight branch guide high power duplexer for pulsed radar applications in the 35,000 mc band. It is designed for

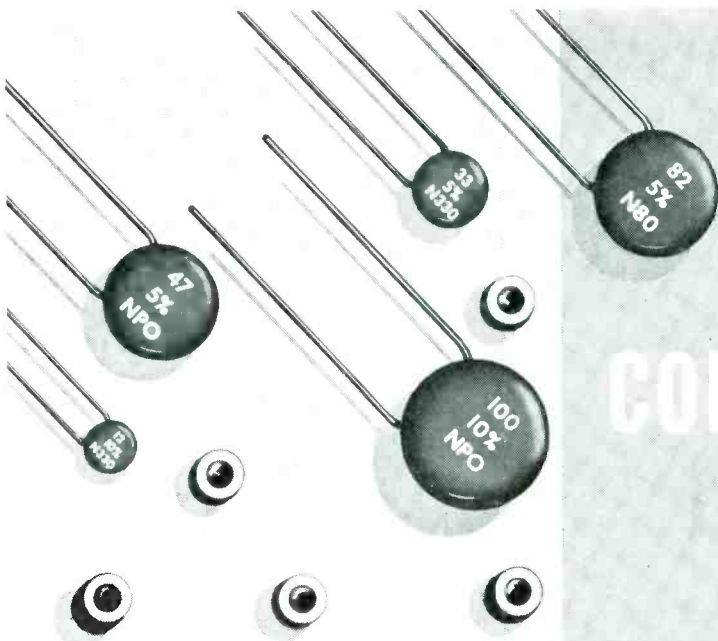

## FOR SUPREME ACCURACY IN

# temperature compensating capacitors —

## try ALLEN-BRADLEY

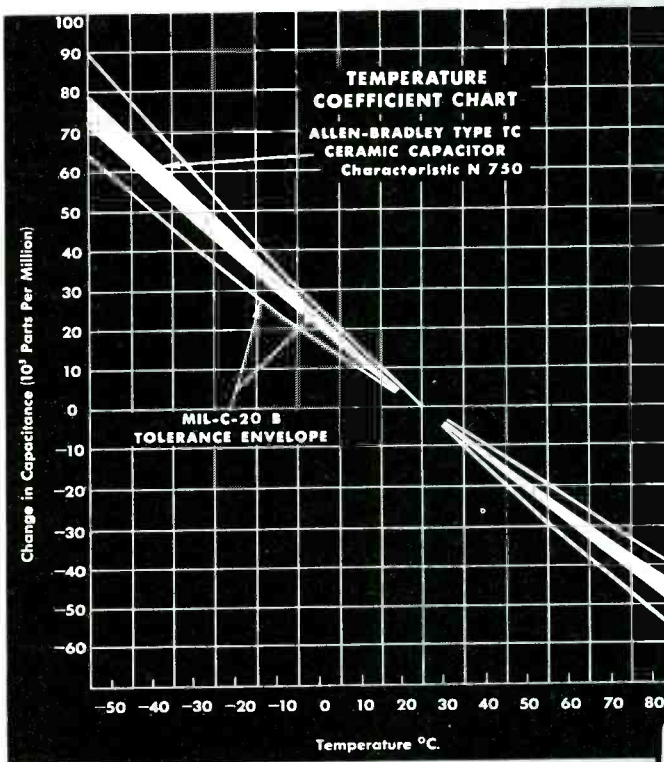

You can obtain greater precision with Allen-Bradley temperature compensating capacitors . . . much more accurate than conventional units . . . more accurate than the requirements of MIL or RETMA specifications.

Allen-Bradley is able to assure this accuracy by producing its own ceramic bodies. Years of experimentation, thousands of tests, and meticulous compounding enable Allen-Bradley to provide the exact characteristics you require. The accompanying temperature coefficient curve—typical of all Allen-Bradley temperature compensating capacitors—illustrates how precisely these characteristics are maintained.

Allen-Bradley temperature compensating capacitors are available from 2.0 to 510 mmf with eleven different temperature characteristics from P-100 to N-1500 in tolerances of  $\pm 5\%$ ,  $10\%$ , and  $20\%$ . Use these quality ceramic capacitors—they cost no more—and they will give you a more stable product.

In modern laboratories, Allen-Bradley physicists conduct exacting tests on ceramic disc capacitors. The data accumulated from many thousands of tests—both electrical and physical—enables Allen-Bradley to produce ceramic disc bodies with exact temperature compensating characteristics.

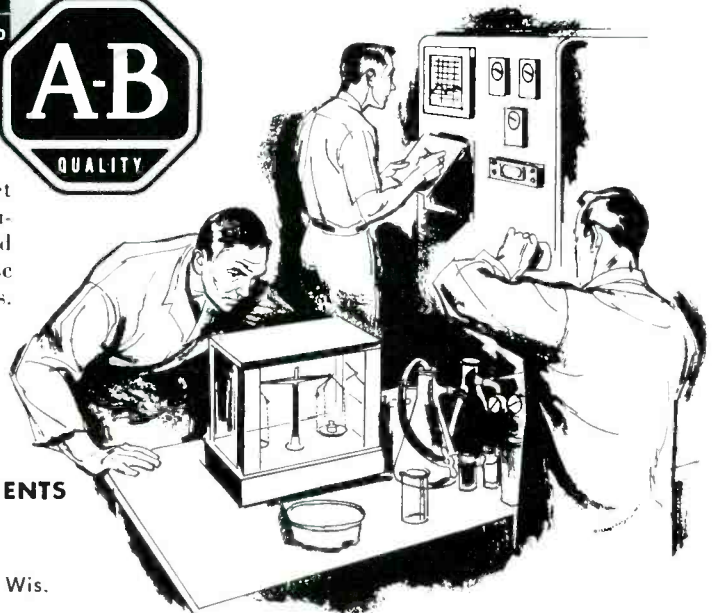

# ALLEN-BRADLEY

RADIO, ELECTRONIC, AND TELEVISION COMPONENTS

Allen-Bradley Co., 110 W. Greenfield Ave., Milwaukee 4, Wis.  
 In Canada: Allen-Bradley Canada Ltd., Galt, Ont.



new from  
**CHICAGO STANDARD**

**HERMETICALLY SEALED  
400 CYCLE  
TRANSFORMERS**

**IN  
MILITARY STANDARD  
CASES**

**in stock for  
immediate delivery**

**POWER TRANSFORMERS—TF4SX03\*** (plate and filament)  
**FILTER REACTORS—TF4SX03\***  
**FILAMENT TRANSFORMERS—TF4SX01\***

These transformers are designed and built in accordance with MIL-T-27A, Grade 4, Class S (85°C. ambient, 45°C. rise), operating temperature and life expectancy X (10,000 hours, minimum). Maximum operating altitude 70,000 feet. Schematics permanently silk-screened on one-piece drawn steel case.

For complete details on these new stock transformers write for the new Chicago Catalog CT3-57.

\* (indicate letter designations that vary with case size.)

## CHICAGO STANDARD TRANSFORMER CORPORATION

3502 Addison Street • Chicago 18, Illinois  
Export Sales: Roburn Agencies, Inc. 431 Greenwich St., New York 13, N. Y.



use with the 5790 TR tube and ATR-5791 (or higher power equivalents) in RG-96/U radar systems.

In a typical radar application the waveguide output flange of a pulsed magnetron such as the MA-207 is connected to the duplexer input flange by means of a magnetron-to-UG-599/U-adaptor (MA-550C). Magnetron output power is coupled to the antenna system transmission line by the UG-600/U output flange of the duplexer.

The duplexer, in conjunction with TR-5790 and ATR-5791, performs the switching operation from transmission to reception necessary in radar applications. Radar echo signals are detected in a balanced mixer (such as the MA-531) connected to the output flange of the TR-5790. **Circle 417 on Reader Service Card.**



### TRANSDUCER with plug-in assembly

AUTOMATIC TIMING & CONTROLS, INC., King of Prussia, Pa., has developed a special transducer featuring a plug-in terminal for lead wires. The terminal assembly is mounted on the outside of the unit's stainless steel shell.

Exceptionally low null voltage of 20 mv rms (maximum) makes possible a sensitivity of 0.49 mv per 0.001 in. displacement per v input at 2,500 cps. Input is 12½ v, 2,500 cps single ended and grounded; impedance is greater than 2,500 ohms. Output is 6.1 v per 1 in. displacement at rated excitation; impedance is less than 700 ohms. Range is ±0.63 in. Phase angle is less than 20 deg between ±0.01 in. and ±0.05 in., less than 16 deg between ±0.05 in. and ±0.5 in.

This design was developed to re-



## All business is specialized

... and nothing specializes on your business like your business paper

Here's a smart business man. He spends his time where every sitzmark parks a prospect at his feet. It's simple sense: He *specializes* . . . and it *pays*!

Your business is specialized, too . . . and so is your business paper. The time you spend with it pays . . . for its editors are experts in your specialty. They scout the field . . . report what's good that's new . . . find ideas that worked . . . suggest methods to keep you a leap ahead of competition.

The ad pages are as specialized as the editing. They, too, tend strictly to business . . . your business. They bring you data on new products, new materials . . . gather in one place a raft of ideas on where-to-buy-what, or how to make (or save) a dollar.

That's help you can't find concentrated into such quick reading time *anywhere* else! It's help that puts many a man out front in his field, as a specialist who knows what's what today . . . sees what's coming tomorrow. It's simple sense to read every page, every issue.

---

This business paper in your hand has a plus for you, because it's a member of the Associated Business Publications. It's a paid circulation paper that must earn its readership by its quality . . . And it's one of a leadership group of business papers that work together to add new values, new usefulness, new ways to make the time you give to your business paper still more profitable time.

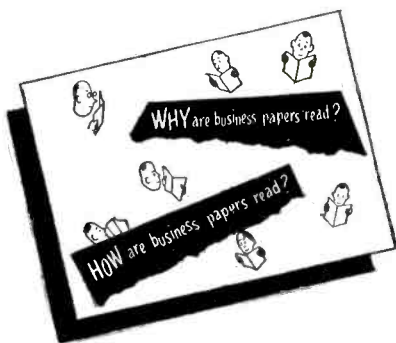

A copy of this quick-reading, 8-page booklet is yours for the asking. It contains many facts on the benefits derived from your business paper and tips on how to read more profitably. Write for the "WHY and HOW booklet." Room 2710.

**McGRAW-HILL PUBLISHING COMPANY**  
330 West 42nd St., New York 36, N. Y.



One of a series of advertisements prepared by THE ASSOCIATED BUSINESS PUBLICATIONS

*Simplifying HF Power Measurement*

## Model 67 **TERMALINE** DIRECT-READING R-F WATTMETER

30 mc to 500 mc  
(to 1000 mc if specified)

50 ohms

Triple Range 0-25 watts  
0-100 " "  
0-500 " "

Type N Input Connector  
(Adaptor for PL-259 supplied)

● Model 67 is a larger type Wattmeter than the well-known AN-ME-11/U (our Model 611) R-F Wattmeter. Specifically designed for fixed station transmitters to 500 watts output, it may be used nicely on low range for mobile gear. Provided with an aluminum cased, shock-mounted meter, Model 67 is as simple to use as a DC voltmeter. Now in general use throughout the industry, **TERMALINE** Wattmeters may be depended upon for fast, accurate and repeatable power readings

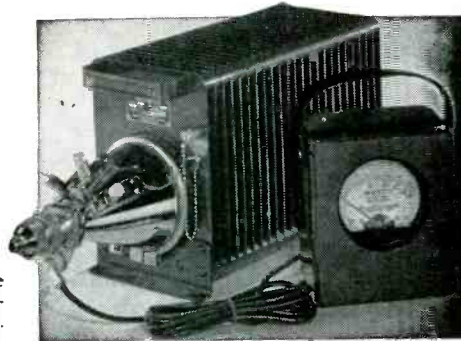

**NON-RADIATING**

... Accuracy — 5%

**RUGGED CONSTRUCTION**

... Size — 17" x 9" x 6"  
Wght. — 30 pounds

place a precision pot as a feedback element in the circuitry of a hydraulic servo missile vane control system. Circle 418 on Reader Service Card.

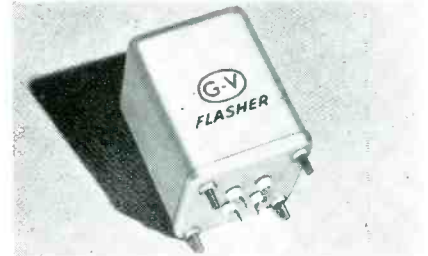

### HEAVY DUTY FLASHER for aircraft and industry

G-V CONTROLS INC., Hollywood Plaza, East Orange, N. J., has available a flasher designed for long life with loads up to 2 amperes at 120 v a-c or 32 v d-c. The type BF unit combines two thermal relays and one magnetic relay, all hermetically sealed, in a circuit in which the load current is handled by the magnetic relay. The thermal relays govern the "on" and "off" portions of the flashing cycle, which is therefore unaffected by load current or load contact erosion.

The unit is suitable for aeronautical use and for industrial service. The flasher is compensated for ambient temperature variation from -65 C to +125 C. It will withstand aircraft vibration and shock requirements. It is contained in a case 2 $\frac{3}{8}$  in. by 2 $\frac{3}{8}$  in. by 3 $\frac{3}{8}$  in. high, and weighs 9 oz. Output contacts are spdt and are isolated from input circuit. Circle 419 on Reader Service Card.

### TWIN POWER TRIODE

for heavy-duty use

TUNG-SOL ELECTRIC INC., 95 Eighth Ave., Newark 4, N. J., has developed the type 6528 twin power triode. A high current, medium mu twin triode developed specifically for series regulator service in d-c power supply units, the 6528 has been designed with high reliability features. Rugged construction has been included within



**BIRD**  
**ELECTRONIC CORP.**  
1800 EAST 38<sup>TH</sup> ST., CLEVELAND 14, OHIO  
**TERMALINE** Coaxial Line Instruments

**VAN GROOS**  
**COMPANY**  
Sherman Oaks, Cal.

CIRCLE 185 READERS SERVICE CARD

**Metallurgists...  
and Specialists in Small Wire...**

**BASE METAL WIRES** ... Very small diameter — for filaments, thermocouples, resistance units.

**PRECIOUS METAL WIRES** ... Produced in Platinum, Gold, alloys and pure metals — small diameter ... Platinum alloy resistance wires.

**COATED WIRES** ... Comprising an extensive range of electroplated grid wires ... Enamel insulated wires for precision resistors, potentiometers.

**ANODIZED ALUMINUM WIRE** ... Insulation at 800°F ... Precision drawn to close resistance in the smaller sizes

Write for List of Products



Serving Industry — for Over 56 Years

**SIGMUND COHN CORP.**

121 SOUTH COLUMBUS AVE., MOUNT VERNON, N. Y.



the unit in order to satisfy the most stringent requirements of heavy-duty military and commercial applications.

The 6528 was designed for use when unusual output characteristics, high reliability or long life are requirements. It makes possible a circuit having fewer components and resulting in a more efficient power supply unit. Circle 420 on Reader Service Card.



**SOLID STATE BATTERY**

delivers high current drains

PATTERSON, MOOS DIVISION of Universal Winding Co., Inc., 90-28 Van Wyck Expressway, Jamaica 18, N. Y., has developed a miniature, h-v solid state battery that is capable of delivering higher current drains for longer periods of time than other comparable batteries.

Called the Dynox 95, the first model of the new battery is 1 1/4 in. long, 3/8 in. in diameter, and has a potential of 95 v in 0.14 cu in. It can supply a steady current of  $1 \times 10^{-9}$  amperes for 176,000 hours at 70 F with only a 10-percent voltage drop, or a flash current of 20  $\mu$ a. Also, it can be stored for 20 years without losing its power.

Other characteristics include resistance to extreme shock or vibration, performance at extreme temperature ranges, including the ability to operate after temperature cycling between -100 and



**HERE'S THE RELAY  
THEY'RE TALKING ABOUT**

**The NEOMITE**

Designers are excited about the unique advantages of Elgin's new *NEOMITE* Relay. It's the world's smallest, weighing just .09 ounces, and requires only 100 milliwatts of power to open and close electrical circuits. *There's nothing like it for size or performance . . . and now they're available from leading distributors.*



**ACTUAL SIZE**  
... only 0.392" x 0.195"  
x 0.530" high.

**SPECIFICATIONS**

Relay Type	NMIC 50	NMIC 200	NMIC 500	NMIC 1K	NMIC 2K
D. C. Coil Resistance ( $\pm 10\%$ @ 20°C)	50 Ohms	200 Ohms	500 Ohms	1000 Ohms	2000 Ohms
Coil Voltage		3-5 V.D.C.	6-10 V.D.C.	9-15 V.D.C.	12-21 V.D.C.
Pickup	44 MA Max.	22 MA Max.	14 MA Max.	10 MA Max.	7 MA Max.

Duty: Continuous  
Dropout: 30 to 60% of pickup  
Contact Rating: .25 AMP at 28 V.D.C. resistive load  
Operation Time: 4 milliseconds max. @ rated voltage  
Dielectric Strength: Sea level: 500V RMS. High altitude: 500 V RMS

Shock: Shock test: 50 G. without damage  
Vibration: 10 G to 500 cps  
Contact Arrangement: SPDT Form C  
Ambient Temperature Range: -55°C to +85°C  
Life: 1,000,000 operations at rated load  
Contact Resistance: .05 Ohms

**YOU'LL FIND WHAT YOU WANT IN  
ELGIN'S ADVANCE RELAY LINE**



Midget Antenna  
AM Series



Latching  
LE & LH Series



Coaxial  
CB Series



Power Control  
PC Series



Power Transfer  
PV Series

. . . it's the most complete line of relays to meet almost every need. And they're available from stock at leading distributors all over the country. Write today for catalog information.



**ELECTRONICS DIVISION**  
ELGIN NATIONAL WATCH COMPANY  
Elgin, Illinois

# NEW...NEW...NEW HIGH STABILITY ERIE "PAC" MODULES

with PRECISION FILM RESISTORS

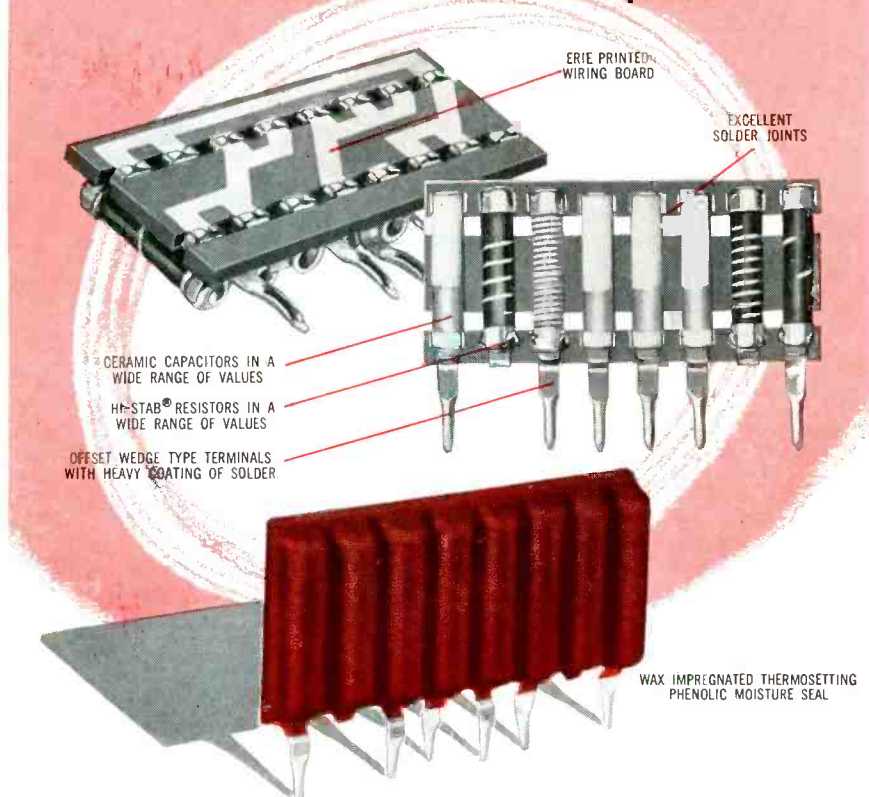

**LESS THAN 0.07% AVERAGE CHANGE  
AFTER 1000 HOUR EXTREME HUMIDITY TEST**

**ERIE "PAC"**  
... THE ONLY MODULE  
THAT INCORPORATES  
PRECISION RESISTOR  
ELEMENTS IN  
ITS BASIC DESIGN

Through the employment of 1/2 watt precision film resistors, ERIE has added to its line of "PAC" modules and greatly widened the field of effective "PAC" applications.

"PAC" Pre-Assembled Components have proven immensely popular with manufacturers of home and auto radios, TV sets, electronic organs, and other equipment.

The new "PAC" units incorporating deposited carbon resistors, are highly resistant to humidity, and offer high reliability for precision military and industrial applications. They have been thoroughly proven in severe humidity tests in which they withstood 1,000 hour exposure with an average change of less than 0.07% and maximum change of 0.19%.

Samples will be submitted for your own trial tests and applications.

170 F. It is hermetically sealed.

The battery has a functional place in modern electronics systems where miniaturization and reliability of performance in extreme environments are required. These applications include power sources in missiles, avionics, alarm systems, instrumentation—such as computers—and telemetering as well as capacitor charging applications. Circle 421 on Reader Service Card.

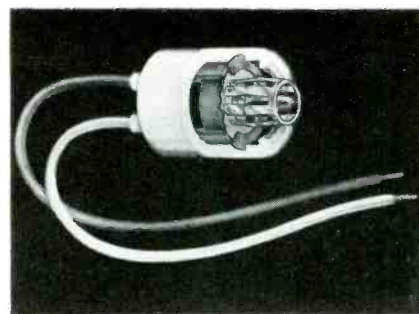

## MAGNETRON CONNECTOR

for space saving design

JETTRON PRODUCTS, Route No. 10, Hanover, N. J. An improved magnetron input connector has the normally exposed metal parts encased in silicone to permit space saving in the power supply design. This assembly will fit any of the following magnetrons: 4J50, 4J52A, 6551 and 6865.

The heater-cathode contact is made of heat treated beryllium copper, heavily silver plated and has eight contact springs making contact with the tube. The heater contact is floating in a silicone rubber insulator which prevents undue strain on the tube input end. All internal connections are made with a high temperature alloy solder and friction contacts have been eliminated. The lead wires are insulated with Silastic 80 so that the connector may be operated at very high temperatures without failure.

Catalog No. 9000-C has a 4,000 μf minimum capacitor built into the connector. Catalog No. 9000 is made without the capacitor, and is identical in outline dimensions. The body of the connector is 1 1/4 in. long and 1 1/8 in. in diameter. A red lead identifies the heater connec-





tion and a white lead identifies the heater-cathode connection. The standard lead length is 12 in. with  $\frac{1}{8}$  in. stripped and tinned. Circle 422 on Reader Service Card.



**CRYSTAL OSCILLATORS**  
are transistorized

REEVES-HOFFMAN DIVISION of Dynamics Corp. of America, Carlisle, Pa. New crystal-controlled oscillators, available over a frequency range of 4 kc to 250 kc, are transistorized for compactness. Length (seated) is  $5\frac{1}{4}$  in.; diameter  $1\frac{3}{8}$  in. These ruggedly built oscillators are capable of surviving shock of 100 g's and withstanding vibration of from 5 to 55 cycles at 0.030-in. total excursion. Output power is 600  $\mu$ w. Frequency stability is  $\pm 0.015$  percent over an ambient temperature range of from -40 C to +60 C. Over the same range of operating temperature, output level stability is  $\pm 2$  db from the 25 C level. The oscillators are mounted in a plug-in octal base. Circle 423 on Reader Service Card.

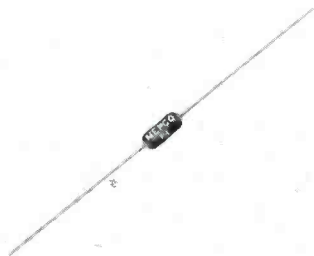

**POWER RESISTOR**  
miniature precision type

MEPCO, INC., Morristown, N. J. Type P-1 is a new addition to the line of precision power resistors

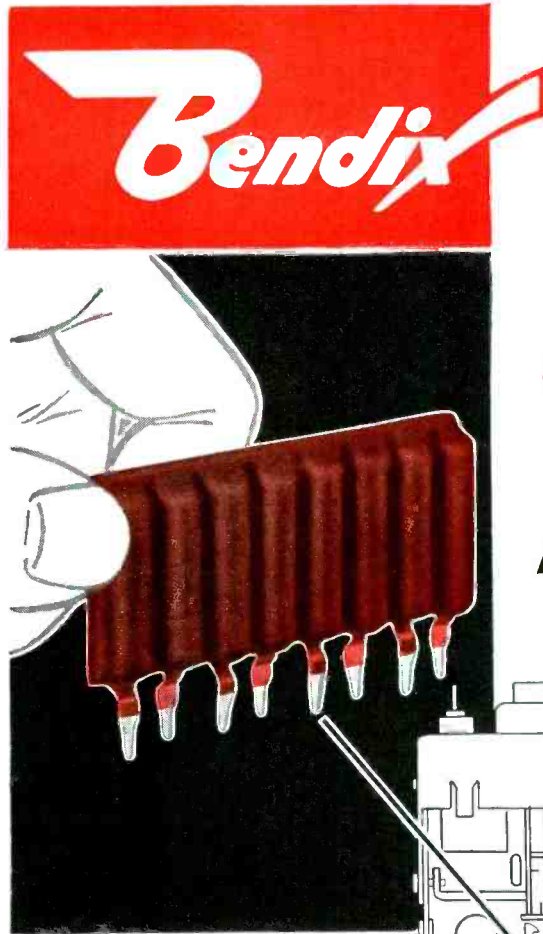

Uses  
**ERIE**  
**"PAC"\***  
in  
**AUTOMOBILE**  
**RADIOS**

**\*WHAT IS "PAC"?**

"PAC" stands for "Pre-Assembled Components". In "PAC" interconnected capacitors and resistors are automatically assembled by ERIE into a unitized module for quick, easy installation by the set manufacturer.

**WHAT DOES "PAC" DO?**

- Speeds Assembly
- Reduces Inventory
- Eliminates Assembly Equipment
- Simplifies Inspection
- Cuts Down Chassis Area
- Reduces Number of Punched Holes
- Reduces Number of Insertions
- Resists Vibration
- Withstands Extreme Temperatures

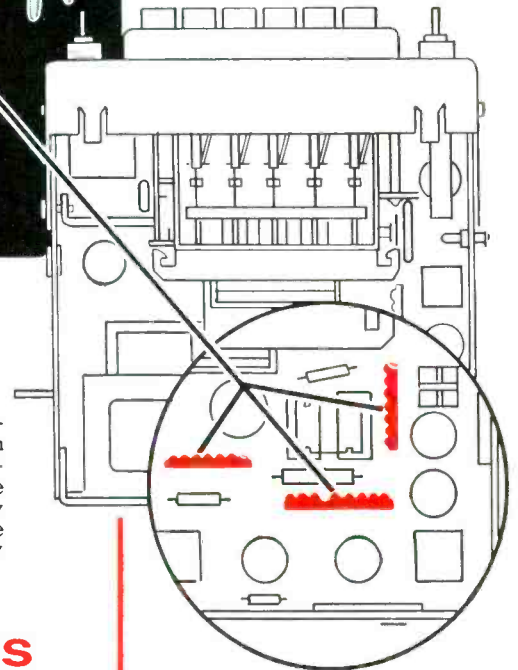

"PAC" is used by many other manufacturers of radios, TV sets, and a wide variety of other electronic equipment. Labor is saved. Design is simplified. Our engineers will be glad to consult with you about incorporating "PAC" in your equipment.

**ERIE** *Electronics Division*  
**ERIE RESISTOR CORPORATION**  
 MAIN OFFICES: ERIE, PA., U.S.A.  
 FACTORIES: ERIE, PA. • HOLLY SPRINGS, MISS. • TRENTON, ONTARIO, CANADA



## PHENOLIC TUBING

# CLEVELITE\*

IS YOUR BEST BUY BECAUSE . . . . .

It is made of the highest quality acid-free kraft paper and the finest electrical-grade resins obtainable.

The processing cycles allow ample time for proper curing, ensuring uniformity and good machinability.

It is available in the diameters, wall thicknesses and lengths you may require.

It is subjected to a thorough and rigid inspection.

This know-how and careful workmanship are the result of many years' experience.

You can depend upon prompt, reliable service at all times.

**CLEVELITE HAS THE COMBINED QUALITIES TO MAKE YOUR PRODUCT BETTER . . . AT LOWER COSTS!**

Write for copy of our latest Clevelite brochure.

Why pay more? For quality products . . . call CLEVELAND!

\*Reg U.S. Pat. Off.

**THE CLEVELAND CONTAINER COMPANY**

6201 BARBERTON AVE. CLEVELAND 2, OHIO

PLANTS AND SALES OFFICES:

CHICAGO • DETROIT • MEMPHIS • PLYMOUTH, WIS. • OGDENSBURG, N.Y. • JAMESBURG, N.J. • LOS ANGELES

ABRASIVE DIVISION of CLEVELAND, OHIO

Cleveland Container, Canada, Ltd., Prescott and Toronto, Ont.

**Representatives:**

NEW YORK AREA: R. T. MURRAY, 604 CENTRAL AVE., EAST ORANGE, N. J.

NEW ENGLAND: R. S. PETTIGREW & CO., 62 LA SALLE RD., WEST HARTFORD, CONN.

CHICAGO AREA: PLASTIC TUBING SALES, 5215 N. RAVENSWOOD AVE., CHICAGO

WEST COAST: IRV. M. COCHRANE CO., 408 S. ALVARADO ST., LOS ANGELES



manufactured by the company. It meets the requirement of MIL-R-26C, style RW 59, characteristic G. One percent is the standard tolerance but it is also available in tolerances down to 0.1 percent on special order. The resistor is rated at 2.5 w at 70 C derate to zero at 275C. Temperature coefficient is 0.002 percent per deg C; length,  $\frac{1}{2}$  in.; diameter,  $\frac{1}{4}$  in. Circle 424 on Reader Service Card.

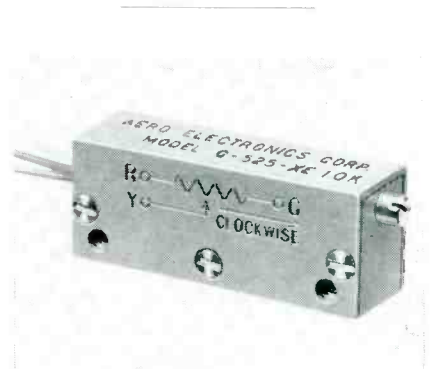

## TRIMMING POT

sealed miniature type

AERO ELECTRONICS CORP., 2311 West Burbank Blvd., Burbank, Calif., is in production on a sealed miniature trimming potentiometer which withstands severe environmental conditions. The unit has a metal body and cover, both "U" shaped, with the cover precision fitted to the body for protection against humidity, splashing and dust. For further protection, the unit is epoxy sealed around the cover and around the leads where they emerge from the case, and a silicone O-ring is placed behind the leadscrew opening. This construction is designed to meet pertinent Mil Specs with reference to humidity requirements.

Built for critical applications, the unit is unusually rigid, and resistant to twisting, impact and breakage. Designated Aero-Pot G-720 series, it is adjustable throughout 32 turns by a screwdriver in a slotted shaft.

Case dimensions are  $1\frac{1}{2}$  in. long,  $\frac{1}{2}$  in. high,  $\frac{1}{8}$  in. wide. Weight is  $\frac{1}{4}$  oz. Resistance range is from 100 ohms to 100,000 ohms in one case size. Resolution, depending on resistance is 0.2 to 2 percent. Linearity is 1 percent. Temperature range is  $-55$  C to  $+175$  C. Units

# Get out your pencil and . . .

## Help yourself to

# electronics' READER SERVICE

## it's free—it's easy—it's for your convenience

**NOW!**

All Advertisements  
New Products, and  
New Literature are  
numbered for your  
convenience.

Each Advertisement, New Product, and New Literature item is numbered.  
For more information simply . . .

- (1) Circle number on postpaid card below that corresponds to number at the bottom of Advertisement or New Product item. Follow the same procedure if you desire New Literature.
- (2) Print your name, title, address, and firm name carefully. It is impossible to process cards that are not readable.

Correct additional postage **MUST** be added to cards for all **FOREIGN MAILINGS**

**DEC**  
**1 • 57**  
**CARD**  
**EXPIRES**  
**MAR • 15†**

• **electronics** • **READER SERVICE CARD**

Please Print Carefully

NAME \_\_\_\_\_ POSITION \_\_\_\_\_

COMPANY \_\_\_\_\_

ADDRESS \_\_\_\_\_

1	2	3	4	5	6	7	8	9	10	11	12	13	14	15	16	17	18	19	20
21	22	23	24	25	26	27	28	29	30	31	32	33	34	35	36	37	38	39	40
41	42	43	44	45	46	47	48	49	50	51	52	53	54	55	56	57	58	59	60
61	62	63	64	65	66	67	68	69	70	71	72	73	74	75	76	77	78	79	80
81	82	83	84	85	86	87	88	89	90	91	92	93	94	95	96	97	98	99	100
101	102	103	104	105	106	107	108	109	110	111	112	113	114	115	116	117	118	119	120
121	122	123	124	125	126	127	128	129	130	131	132	133	134	135	136	137	138	139	140
141	142	143	144	145	146	147	148	149	150	151	152	153	154	155	156	157	158	159	160
161	162	163	164	165	166	167	168	169	170	171	172	173	174	175	176	177	178	179	180
181	182	183	184	185	186	187	188	189	190	191	192	193	194	195	196	197	198	199	200
201	202	203	204	205	206	207	208	209	210	211	212	213	214	215	216	217	218	219	220
221	222	223	224	225	226	227	228	229	230	231	232	233	234	235	236	237	238	239	240
241	242	243	244	245	246	247	248	249	250	251	252	253	254	255	256	257	258	259	260
261	262	263	264	265	266	267	268	269	270	271	272	273	274	275	276	277	278	279	280
281	282	283	284	285	286	287	288	289	290	291	292	293	294	295	296	297	298	299	300
301	302	303	304	305	306	307	308	309	310	311	312	313	314	315	316	317	318	319	320
321	322	323	324	325	326	327	328	329	330	331	332	333	334	335	336	337	338	339	340
341	342	343	344	345	346	347	348	349	350	351	352	353	354	355	356	357	358	359	360
361	362	363	364	365	366	367	368	369	370	371	372	373	374	375	376	377	378	379	380
381	382	383	384	385	386	387	388	389	390	391	392	393	394	395	396	397	398	399	400
401	402	403	404	405	406	407	408	409	410	411	412	413	414	415	416	417	418	419	420
421	422	423	424	425	426	427	428	429	430	431	432	433	434	435	436	437	438	439	440
441	442	443	444	445	446	447	448	449	450	451	452	453	454	455	456	457	458	459	460
461	462	463	464	465	466	467	468	469	470	471	472	473	474	475	476	477	478	479	480
481	482	483	484	485	486	487	488	489	490	491	492	493	494	495	496	497	498	499	500
501	502	503	504	505	506	507	508	509	510	511	512	513	514	515	516	517	518	519	520
521	522	523	524	525	526	527	528	529	530	531	532	533	534	535	536	537	538	539	540
541	542	543	544	545	546	547	548	549	550	551	552	553	554	555	556	557	558	559	560
561	562	563	564	565	566	567	568	569	570	571	572	573	574	575	576	577	578	579	580
581	582	583	584	585	586	587	588	589	590	591	592	593	594	595	596	597	598	599	600

INSIDE FRONT COVER

INSIDE BACK COVER

BACK COVER

Some Advertisements which cannot be numbered for the READER SERVICE CARD due to lack of space, must be indicated by writing the Advertiser's name in the space provided at the bottom of the

card . . .



# YOU WILL RECEIVE 53 ISSUES IN 1958

alternate  
engineering  
and business  
editions  
plus . . .  
the  
buyers' guide

electronics  

A MCGRAW-HILL PUBLICATION  
330 WEST 42nd STREET, NEW YORK 36, N.Y.

## CHART OF PUBLISHING CYCLES

electronics engineering edition	electronics business edition	electronics engineering edition	electronics business edition
CYCLE A	CYCLE B	CYCLE C	CYCLE D
JAN. 3	JAN. 10	JAN. 17	JAN. 24
JAN. 31	FEB. 7	FEB. 14	FEB. 21
FEB. 28	MAR. 7	MAR. 14	MAR. 21
MAR. 28	APR. 4	APR. 11	APR. 18
APR. 25	MAY 2	MAY 9	MAY 16
MAY 23	MAY 30	JUNE 6	JUNE 13
JUNE 20	JUNE 27	JULY 4	JULY 11
JULY 18	JULY 25	AUG. 1	AUG. 8
AUG. 15	AUG. 22	AUG. 29	SEPT. 5
SEPT. 12	SEPT. 19	SEPT. 26	OCT. 3
OCT. 10	OCT. 17	OCT. 24	OCT. 31
NOV. 7	NOV. 14	NOV. 21	NOV. 28
DEC. 5	DEC. 12	DEC. 19	DEC. 26

**BUYERS' GUIDE ISSUE—JUNE 15**

FIRST CLASS  
PERMIT NO. 64  
(Sec. 34.9 P.L.&R.)  
NEW YORK, N. Y.

**BUSINESS REPLY CARD**

NO POSTAGE STAMP NECESSARY IF MAILED IN THE UNITED STATES

4¢ Postage Will Be Paid By

**ELECTRONICS**

Reader Service Dept.

330 West 42nd Street

New York 36, N. Y.

are supplied with Teflon insulated wire leads or plug-in terminals. Circle 425 on Reader Service Card.

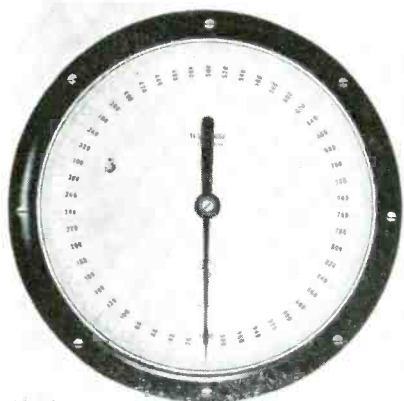

### TEST GAGES

readings up to 15,000 lb

MARTIN-DECKER CORP., 3431 Cherry Ave., Long Beach 7, Calif., has developed a new series of precision test gages. An improved technique in the manufacture of the Bourdon tube, coupled with an advanced design movement, makes possible a 360 deg calibration. A 12 in. 360 deg calibrated gage provides the same readability obtained in a 16 in. 270 deg dial.

Test gage performance has been improved to permit readings up to 15,000 lb. Guaranteed production calibration is 0.15 percent full scale accuracy. Flush, wall, or stem mount is available. Sizes range from 60 psi to 15,000 psi. Circle 426 on Reader Service Card.



### PRECISION POTS

two new types

INTERNATIONAL RESISTANCE Co.,  
401 North Broad St., Philadelphia

# Now—

## NO plate too small— 213B

## NO panel too big

# NO size limits on engraving

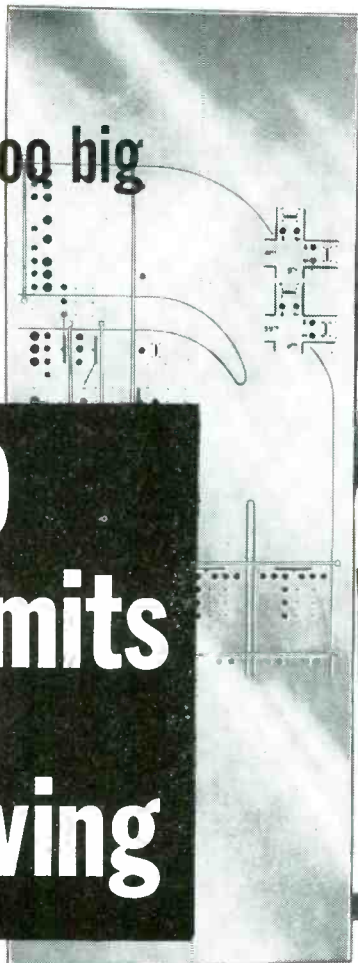

The new ENGRAVOGRAPH Model I-R takes up only 2 feet of bench space and engraves anything from tiny nameplates to giant panels. Engraving chassis can be detached from base and placed directly on workpiece of any dimension. Smaller plates can be easily clamped in a self-centering workholder which is standard equipment.

New sturdy pantograph construction; heavy duty cutter spindle; two-way depth regulator.

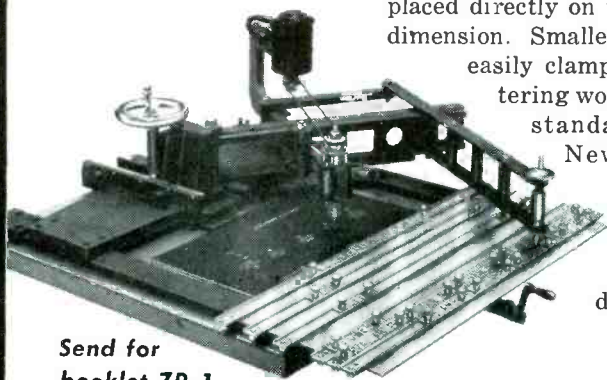

Send for  
booklet ZR-1

**new hermes ENGRAVING MACHINE CORP.**

13-19 University Place, New York 3, N.Y.

# NEW!

## Syncramental motor provides precise bi-directional stepping

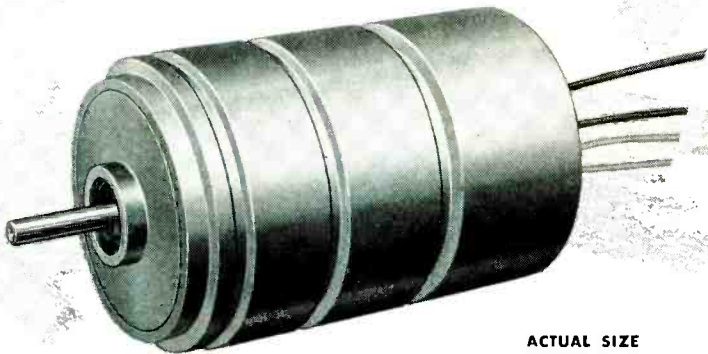

ACTUAL SIZE

The Syncramental Motor accurately translates pulses to incremental shaft position for conversion of digital information to analogous shaft displacements. Compact, long-life power can rotate potentiometers, counters, rotary switches, control mechanisms.

A special magnetic clutch mechanism, rather than ratchets, indexes the shaft. Clutch and detent mechanism are mounted between two LEDEX Rotary Solenoids whose armature plates face each other. Clutch rotates with one or the other of the energized armatures, to which it has been magnetically attracted, causing shaft rotation. Solenoid de-energizing returns the armature to original position, but clutch and shaft are held in displaced position by the detent.

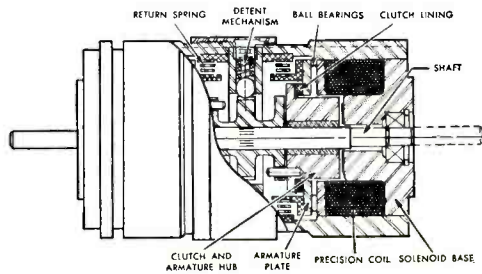
**PERFORMANCE:**

Angular increment per pulse— $36^\circ$  (either direction). Detent accuracy— $\pm 1/2^\circ$  under no load conditions. Maximum stepping rate—15 per second. Load capacity—up to 2 lb. in. starting torque at  $20^\circ\text{C}$ . Life expectancy—2 million steps in either direction.

**ENVIRONMENTAL CONDITIONS:**

Temperature—minus  $55^\circ\text{C}$ . to  $120^\circ\text{C}$ . Altitude—up to 90,000 ft. Meets applicable requirements of MIL-E-5272A.

**SIZE, MOUNTINGS:**

Dimensions—1.500" dia. x 2.525" long. Weight—13 oz. Mountings—standard Servo.

*Write today for complete data...*



**G.H. Leland**  
INC.

123 WEBSTER STREET, DAYTON, OHIO  
IN CANADA: Marsland Engineering Ltd., Kitchener, Ontario  
IN EUROPE: NSF Ltd., 31-32 Alfred Place, London, England

8, Pa., has added two new precision potentiometers, types HA-100 and HA-105 to its product line. Available in 5 and 10-turn types, these units feature very short case lengths— $1\frac{1}{8}$  in. on 5-turn model and  $1\frac{1}{4}$  in. on 10-turn. Encased in grade XX laminated phenolic with a polished natural finish, the units can be furnished with flexible silver plated terminals riveted to case, or with rigid turret-type terminals. Standard linearity is  $\pm 0.5$  percent.

Type HA-100, rated at 2 w. features rotation of  $3,600^\circ$ ,  $-0^\circ$  deg  $+4^\circ$ . Standard resistance values are from 2,500 to 75,000 ohms. Type HA-105 is rated at 1.5 w and has rotation of  $1,800^\circ$ ,  $-0^\circ$  deg  $+4^\circ$ . Standard resistance values are 1,000 to 25,000 ohms. Circle 427 on Reader Service Card.



### MINIATURE R-F TUBE with internal shield

AMPEREX ELECTRONIC CORP., 230 Duffy Ave., Hicksville, L. I., N. Y., has available the new ECC85/6AQ8, a miniature, high-mu, high transconductance twin triode. It has been specifically designed for use in a-m and f-m receivers as a grounded-grid or grounded-cathode r-f amplifier and as a self-oscillating frequency converter or cascode amplifier. Through the use of an internal shield, separating both triode sections, the ECC85/6AQ8 reduces oscillator radiations from the antenna of the receiver to an extent not obtainable with previously available

twin-triodes. Higher transconductance permits increased front-end gain and lower noise. Circle 428 on Reader Service Card.

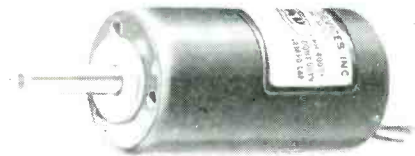

### INDUCTION MOTOR

60-cycle unit

EASTERN AIR DEVICES, INC., 385 Central Ave., Dover, N. H. A new, 60-cycle induction motor has been announced for fan and blower drive or general purpose induction drive motor applications. A one-inch diameter unit, it operates off the 115 v, 60-cycle line directly—without the use of step down transformers or dropping resistors.

With a stall torque of 0.7 oz in. and a running torque of 0.4 oz in., the new motor can get more air from bigger fans than other components of its type. High starting torque means especially good reliability at low temperatures where bearing friction becomes important.

As an example of its power-capacity, the new unit can drive a 3-in. fan blade at 3,200 rpm, or a 4-in. fan blade at 2,700 rpm with only 6 w input. Circle 429 on Reader Service Card.

### CLUTCHES

and clutch brakes

STERLING PRECISION CORP., 34-17 Lawrence St., Flushing 54, N. Y. A group of reverse acting electromagnetic clutches and clutch brakes have been added to the company's line of precision servo components. These units differ from the conventional types in that the input and output shafts

# NEW HIGH CURRENT VOLTAGE and CURRENT REGULATION with LIMITING! (in a single unit)

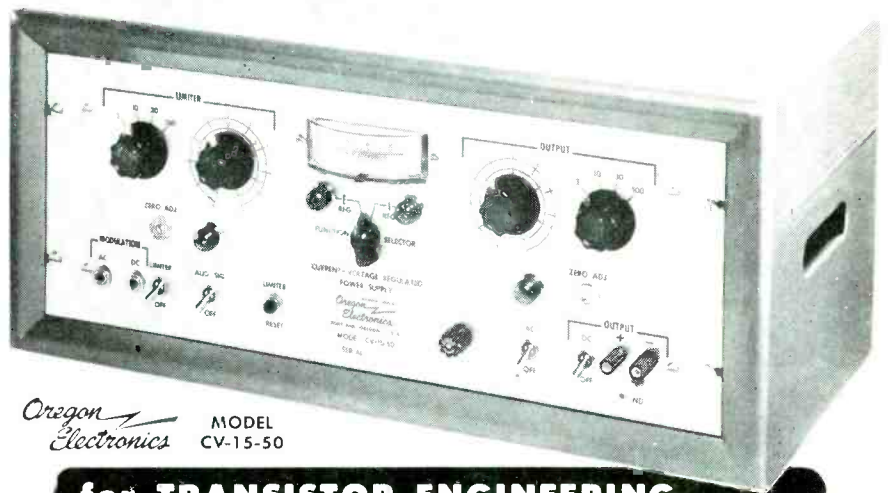

*Oregon Electronics* MODEL CV-15-50

## for TRANSISTOR ENGINEERING

For the first time you can have a power supply that will protect transistors from overload... both voltage and current! Set for maximum voltage on the limiter control and the output power will be interrupted **before** the limit is exceeded. (An audible or visual alarm can also be used). When used for regulated voltage supply, the system becomes a current limiting circuit.

### SPECIFICATIONS

- INPUT:** Nominal 117V, 50-60 cycles.  
**OUTPUT:** Voltage regulated ranges—0-5; 0-15; 0-50; 0-150 volts and Current regulated ranges of 0-15; 0-50; 0-150; 0-500 milliamperes. Output floating or either positive or negative grounded.  
**REGULATION:** Voltage—better than 0.05%. Current—better than 0.2%.  
**RIPPLE:** Voltage—Less than 2mv peak-peak. Current—Less than 2mv peak-peak across 100 ohm load.  
**LIMITER:** Provides visual and audible alarm or visual and cutout as selected. Same ranges as output. Adjustable by means of panel control.  
**MODULATION & EXTENDED CONTROL:** Plugging jacks provide for external modulation or adjustment of current regulated output and extended or remote adjustment of voltage output.  
**METER:** Dual range 5-15 and multipliers.  
**PANEL:** Anodized aluminum—natural or satin black. Standard rack width, 7" high.  
**CABINET:** Heavy gauge steel finished in silver grey smooth baked enamel.

*Oregon Electronics*

Write for complete information

2105 S. E. SIXTH AVE.  
PORTLAND 14, OREGON  
BELmont 6-9292

MANUFACTURERS OF SPECIAL ELECTRONIC EQUIPMENT

## COLOR TV SHADOW MASKS

—A development of BUCKBEE MEARS through close cooperation with TV industry engineers. Containing 400,000 close tolerance holes (.010"  $\pm$  .0005"). Now produced in quantity on our especially designed continuous etching machines.



**BUCKBEE MEARS COMPANY**

TONI BUILDING  
SAINT PAUL 1, MINN.

## ETCHED AND ELECTRO-FORMED PRECISION PARTS

—Electric shaver combs, metal reticles for optical instruments, fine tube mesh and code discs. These are but a few of the variety of parts that can be quickly produced to precise tolerances by our process. Send your specific problem and specifications to our engineers.

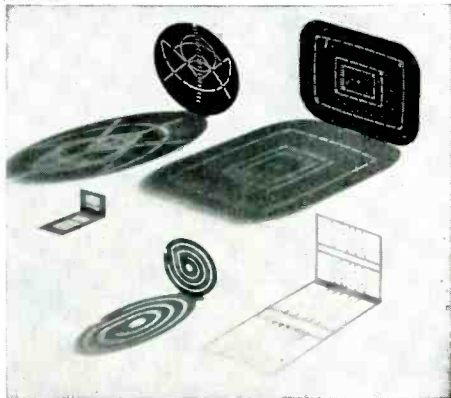

CIRCLE 194 READERS SERVICE CARD

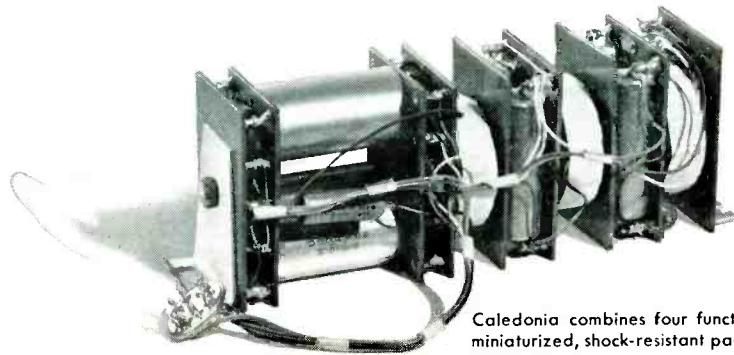

Caledonia combines four functions in miniaturized, shock-resistant package.

## Electronics today is partly packaging

**PROBLEM:** Design a small (50 cubic in.) and light (3¾ lbs.) unit that contains:

1. a positive d.c. pulse selector
2. a negative d.c. pulse selector
3. a high level 60 cps band pass filter
4. a 400 cps detector circuit (all with tight tolerances, naturally).

Design it to operate within the usual military environmental conditions, including high vibration and shock.

**SOLUTION:** We assembled the components shishkabob style. Then mounted the



shishkabob in a metal case filled with an epoxy foam compound to hold the parts in a firm cushion.

**TIME ELAPSED:** From original assignment, through design to volume production—two months.

If such quick, dependable assistance in design and production can make your work more effective, we'll be glad to hear from you. We offer experience, good production facilities, and a recognized quality record.

**CALEDONIA**  
ELECTRONICS AND TRANSFORMER CORPORATION

Dept. E-12, Caledonia, N.Y. • In Canada: Hackbusch Electronics, Ltd., 23 Primrose Ave., Toronto 4, Ont.



are coupled when the coil is energized. Energization of the coil uncouples the shafts and applies the brake to the output shaft if a brake is required. This mode of operation results in conservation of power in many applications. Coupling faces may be supplied flat or with crown teeth resulting in a wide range of torque transmission abilities. Braking surfaces are flat and are rated 8 oz in. minimum torque. Circle 430 on Reader Service Card.



## TEST-POINT JACKS

are micro-miniaturized

SEAELECTRO CORP., 610 Fayette Ave., Mamaroneck, N. Y. Types SKT-13 and SKT-14 are approximately one-third and one-half, respectively, the 0.637 in. overall length of the SKT-10 miniature test-point jack.

Taking a 0.040 in. pin, the SKT-13 measures only 0.203 in. overall length including turret lug, by 0.140 in. straight-sided bushing diameter. The SKT-14, taking a 0.060 in. pin, measures 0.345 in. overall length including lug, by 0.148 in. bushing diameter.

Both types feature machined beryllium-copper contact members with gold flash over silver-plate



finish. The ideal Teflon insulation provides a voltage rating of 750 rms and flashover of 3,000 at sea level, or 1,300 at 50,000 ft, in a temperature range of -65 to +200 C. The SKT-14 is readily, quickly and permanently press-fitted in drilled or punched metal-chassis holes up to 0.140 in. chassis thickness, by means of a simple insertion tool available from Sealectro, used with drillpress or arbor type equipment. They come in a choice of eight RETMA code colors. Circle 431 on Reader Service Card.

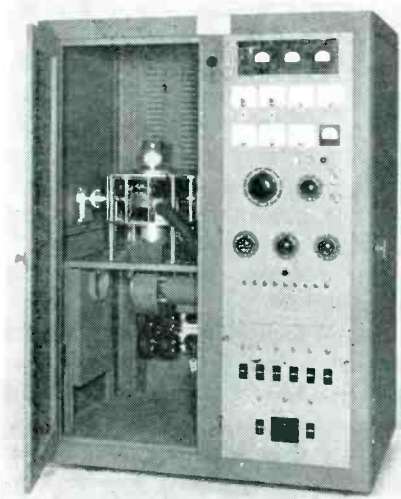

**TRANSMITTER**  
1-kw klystron unit

LEVINTHAL ELECTRONIC PRODUCTS, INC., Stanford Industrial Park, Palo Alto, Calif. Model 74T transmitter produces 1 kw of c-w power over the band 1,700 to 2,400 mc. It utilizes an Eimac 3K2500SG klystron with a power gain of 25 db.

The transmitter consists of a beam-power supply, focus-electrode supply, klystron-filament supply, three focus-magnet supplies, and all required controls, meters, interlocks, indicators and so forth to comprise a complete system. The unit is packaged in a single cabinet with connections available for input and output r-f and a-c power.

Incidental f-m is below 5 cps. With proper modulation of the r-f drive, the unit is capable of a-m, f-m, fsk, or ssb modulation. The equipment requires about 10 kva of power from a 208-v, 3-phase,

**DECADE RESISTANCES**



**DECADE BOX**

... with precision wirewound resistors mounted on steatite-insulated switches. TEN resistors per decade ... giving better than 0.1% accuracy above 10 ohms.

Type	Dials	Ohm Steps	Total Resistance—Ohms	Price
817	3	0.01	11.1	\$60.00
818	3	0.1	111	51.00
820	3	1	1,110	56.00
821	3	10	11,100	60.00
822	3	100	111,000	63.00
823	3	1,000	1,110,000	77.00
824	3	10,000	11,100,000	120.00
817-A	4	0.01	111.1	75.00
819	4	0.1	1,111	71.00
825	4	1	11,110	77.00
826	4	10	111,100	79.00
827	4	100	1,111,000	92.00
828	4	1,000	11,110,000	139.00
8285	5	0.1	11,111	94.00
829	5	1	111,110	101.00
830	5	10	1,111,100	113.00
831	5	100	11,111,000	155.00
817-C	6	0.01	11,111.1	105.00
8315	6	0.1	111,111	109.00
832	6	1	1,111,110	121.00
833	6	10	11,111,100	169.00



**UNMOUNTED DECADE**

Type*	Dials	Ohm Steps	Total Resistance—Ohms	Price
435	1	0.1	1	\$12.00
436	1	1	10	13.25
437	1	10	100	13.25
438	1	100	1,000	15.00
439	1	1,000	10,000	16.00
440	1	10,000	100,000	18.50
441	1	100,000	1,000,000	32.50
442	1	1,000,000	10,000,000	60.00

\* Knob (≠M-25594) not included. Available at additional cost.

**Shallcross**

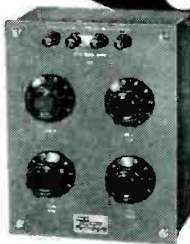

**DECADE VOLTAGE DIVIDERS**

... same quality construction as in Decade Resistances. Choice of Kelvin-Varley or conventional potentiometer circuits.

**KELVIN-VARLEY CIRCUIT**

Type	Dials *	Input Resistance (Accuracy ±0.05%)	Price
8350	4	10,000	\$140.00
8349	4	50,000	145.00
8348	4	100,000	150.00

\* RESOLUTION—Any ratio between 0.0000 and 1.0000 in steps of 0.0001.

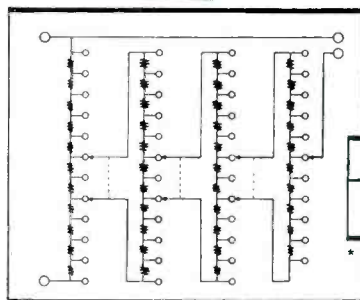

**POTENTIOMETER CIRCUIT**

Type	Dials	Ohm Steps	Total Resistance (Accuracy ±0.1%)	Price
837	4	0.1	1,000	\$126.00
835	4	1.0	10,000	139.00
836	4	10.0	100,000	146.00
849	5	0.1	10,000	165.00
848	5	1.0	100,000	176.00

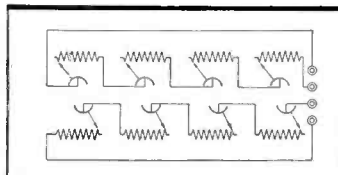

**SHALLCROSS MANUFACTURING COMPANY, 522 Pusey Avenue, Collingdale, Pa.**

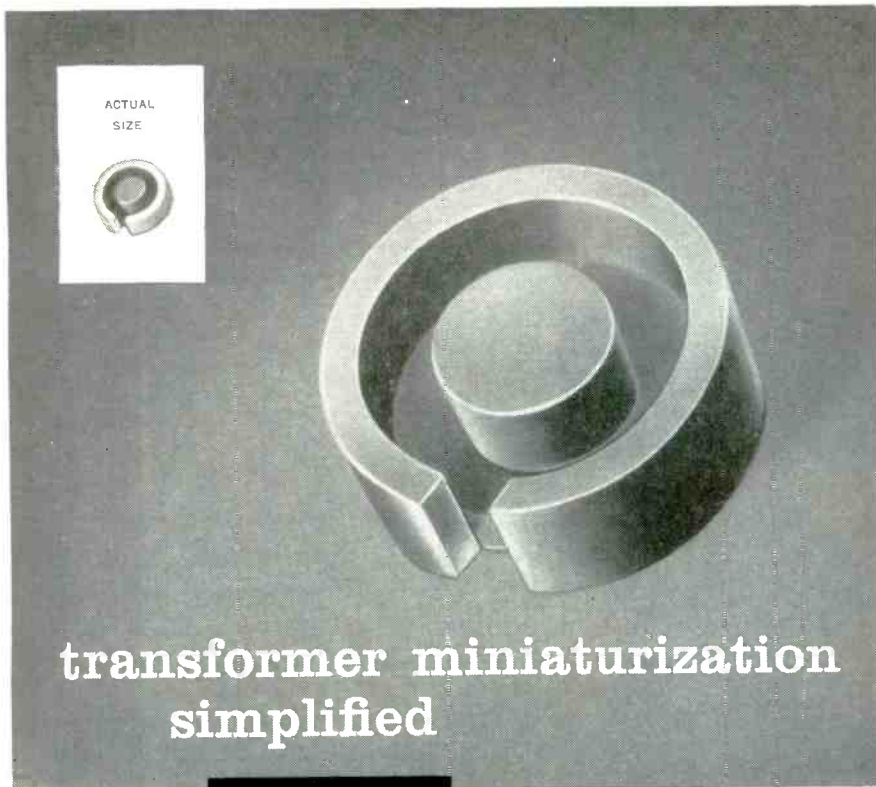

transformer miniaturization  
simplified

with

**FXC**

micro-miniature  
**potcores**

Made of Ferroxcube 3C material, the No. 332P133-3C potcore by FXC is less than  $\frac{3}{8}$ " in diameter and successfully eliminates pulse transformer problems created by limitations in weight and space. The coils for this potcore are wound on a specially designed nylon bobbin. The shape of the potcore, combined with the high-permeability material surrounding the windings, gives excellent shielding and effectively minimizes stray fields. The potcores can be placed close together or even stacked, with negligible coupling between coils.

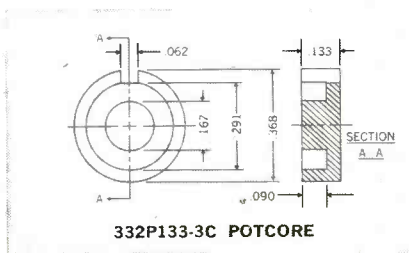

332P133-3C POTCORE

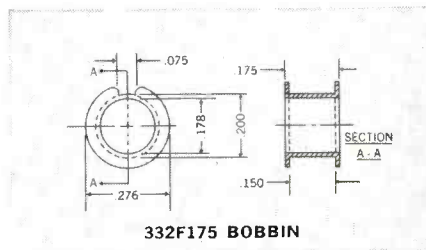

332F175 BOBBIN

*Requests for literature and engineering samples should be made on your company letterhead and addressed to:*

Applications Engineering Department  
**FERROXCUBE CORPORATION OF AMERICA**  
(A subsidiary of North American Philips Co., Inc.)  
50 South Bridge Street, Saugerties, New York

4-wire, 60-cps source. **Circle 432**  
on Reader Service Card.



### CONVERTER

matches ER-90 X-Y plotter

MANDREL INDUSTRIAL INSTRUMENTS, Division of Mandrel Industries Inc., P. O. Box 13243, Houston, Texas, is now marketing a polar Cartesian coordinate converter priced at \$390. Model ER-95 converter was designed specifically to match the ER-90 X-Y plotter. It is applicable, however, anywhere conversion from polar to Cartesian coordinates is required. Conversion is achieved by a sine-cosine pot linked to a null-seeking servo. The value of "R" impressed across the pot is therefore resolved into its quadrature components according to the position of the pot, this position being determined by the  $\theta$  input. Speed of pot positioning is 360 deg per sec and  $\theta$  sensitivity is 0.5 mv d-c per deg. Power required by the self-contained power supply is 50 w at 115 v, 60 cps. Overall size is 6 in. by 7 in. by 19 in. and the unit may be either rack mounted or used as a bench instrument. **Circle 433 on Reader Service Card.**

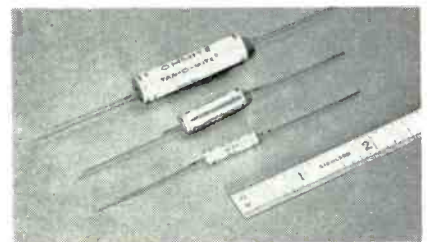

### ELECTROLYTICS

tantalum foil type

OHMITE MFG. CO., 3653 Howard St., Skokie, Ill., has developed a line of high quality, tantalum foil, electrolytic capacitors, and is producing these in limited quantities for

engineering evaluation and use. Carrying the trade designation "Tan-O-Mite", a designation which also applies to Ohmite's tantalum wire units, the series TF capacitor features the extraordinary shelf and operating life, stability and greater capacitance per unit volume that is characteristic of tantalum metal units. Wide operating temperature range ( $-55^{\circ}\text{C}$  to  $+85^{\circ}\text{C}$ ) is another feature of these capacitors.

Supplied in sealed metal cases in three sizes the Series TF units collectively offer a capacitance range of 0.25 to 140  $\mu\text{f}$ . Working voltages up to 150 v are available.

Polar Tan-O-Mite capacitors are provided for d-c application where reversals of potential do not occur, and non-polar units where reversals do occur or for a-c applications of limited voltage. Circle 434 on Reader Service Card.



## TRANSDUCER

operates from  $-90^{\circ}\text{F}$  to  $+275^{\circ}\text{F}$

G. L. COLLINS CORP., 2820 E. Hullett St., Long Beach 5, Calif. New design of a telemetering position transducer provides a frequency change of 4.0 percent in the associated oscillator circuit with each inch of shaft movement. The new unit forms the inductive portion of a Hartley type oscillator employing a single triode tube. Output signals of up to 10 transducers can be mixed and transmitted on a single channel to a remote receiver which will separate the signals by filtering.

The unit operates with a center frequency from 900 cps to 6,000 cps. Frequency change is linear within 1 percent over a stroke of 3.2 in. and frequency drift with

look what **\$24<sup>50</sup>** buys  
in test equipment!



**HEATHKITS  
GIVE YOU  
TWICE AS MUCH  
equipment for  
every dollar  
invested**

The famous model V-7A Vacuum-Tube-Voltmeter is a perfect example of the high-quality instruments available from Heath at  $\frac{1}{2}$  the price you would expect to pay! Complete, only **\$24<sup>50</sup>**

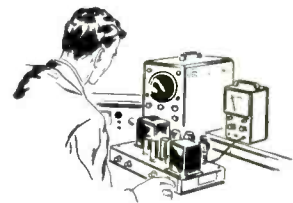

Get the most out of your test equipment budget by utilizing HEATHKIT instruments in your laboratory or on your production line. Get high quality equipment, without paying the usual premium price, by dealing directly with the manufacturer, and by letting engineers or technicians assemble Heathkits between rush periods. Comprehensive instructions insure minimum construction time. You'll get more equipment for the same investment, and be able to fill your needs by choosing from the more than 100 different electronic kits by Heath. These are the most popular "do-it-yourself" kits in the world, so why not investigate their possibilities in your particular area of activity! Write for the free Heathkit catalog now!



Contains detailed descriptions of Heathkit models available, including VTVM's, scopes, generators, testers, bridges, power supplies, etc.



Also describes Heathkit ham gear and hi-fi equipment in kit form. 100 interesting and profitable "do-it-yourself" projects!

**FREE catalog**

Mail coupon below for  
your copy—Now!

**HEATH COMPANY**  
A SUBSIDIARY OF DAYSTROM, INC.,  
BENTON HARBOR 14, MICHIGAN

Name \_\_\_\_\_

Address \_\_\_\_\_

City & Zone \_\_\_\_\_

State \_\_\_\_\_

*Low Cost!*  
*High Efficiency!*

# UAC Transistorized Mobile Power Supplies



- for Transceivers
- for Receivers
- for Railroad Applications

Compact, lightweight units specifically designed to convert battery voltage DC to high voltage DC in two-way radios, public address amplifiers, or wherever conventional power supplies are used. UAC units are rugged, vibration-resistant converters that outlast vibrator power supplies by thousands of hours. No moving parts . . . No wear . . . No tear . . . No arching.

SPECIFICATIONS	
TRANSCIVER SUPPLY	RECEIVER SUPPLY
INPUT: 12 VDC*	12 VDC or 13.6 VDC*
OUTPUTS: 450 VDC @ 255 MA 275 VDC @ 150 MA — 55 VDC @ 5 MA	250 VDC @ 130 MA or 290 VDC @ 130 MA
TEMPERATURE RANGE: — 55°C to +71°C	— 55°C to +71°C
EFFICIENCY: 85%	85%
SIZE: 3 1/2" x 5" x 3"	2 3/4" x 2 3/4" x 2 3/8"
WEIGHT: 3 1/2 lbs.	8 oz.
LIST PRICE: \$85	\$45

\*For Railroad Applications:  
Same Specifications with 64 to 72 VDC Input at additional cost.



**UAC** Electronics  
A DIVISION OF  
**UNIVERSAL** Transistor Products Corp.

Dept. E127      36 Sylvester Street      Westbury, L. I., N. Y.  
Edgewood 3-3304      Cable Address: UNIVATOMS

temperature is less than 0.1 percent per 100 F. Harmonic content is less than 1 percent. The new transducer has an operating temperature range of -90 F to +275 F, is 6.5 in. long and weighs 8.2 oz. Circle 435 on Reader Service Card.



## DIGITAL INSTRUMENTS

feature in-line readouts

ZINN INSTRUMENTS, P. O. Box 733, Lomita, Calif., has announced a complete line of digital instruments including digital voltmeters, ohmmeters, frequency meters and ratiometers. All units feature in-line readouts, small size, two-way tracking if desired, and plug-in packaging of all tubes and stepping switches.

The unit illustrated is a three-digit volt-ohmmeter with an accuracy of one digit on d-c volts and ohms, and 1 percent on a-c volts. Overall size is 3 1/2 in. by 19 in. by 11 in. Some four digit models fit into this same package with an accuracy up to 0.01 percent. Circle 436 on Reader Service Card.

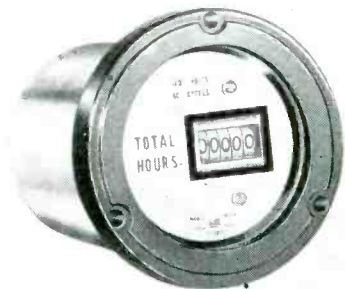

## INDICATOR

shows elapsed time

DEJUR-AMSCO Corp., 45-01 Northern Blvd., Long Island City 1,

N. Y., has available the series HD-656 sealed elapsed time indicator. This 2½ in. diameter meter is enclosed in a housing which meets military specifications, and has five, easy-to-read digit counters that register 1/10 minute or 1/10 hour increments to 9,999.9, or hour steps to 99,999. It provides a check on operating times of machine tool, electronic and similar equipment to insure proper maintenance and replacement at desired intervals.

The unit is equipped with a self-starting synchronous motor for 110-125 v, 60 cycles a-c, and capable of operating continuously from -55 C to +85 C. Sealed housing is a combination of sturdy drawn steel case and die cast aluminum mounting flange. Sealed solder lugs are also standard.

Complete specifications and outline drawing are available. Circle 437 on Reader Service Card.



### PRECISION POT

linear or nonlinear

WATERS MFG., INC., Boston Post Road, Wayland, Mass. Resistance values from ½ ohm to 500,000 ohms with standard linearity of 0.5 percent are available in the modern WP1-⅝ precision potentiometer. Linearities to 0.1 percent are possible as well as top conformity for nonlinear designs. The potentiometer is contained in an anodized aluminum case 1⅝ in. in diameter and 1½ in. deep behind the panel. Turret type terminals mounted on a fungusproof insulating strip of high-impact Epon-glass laminate are provided for circuit connection. Servo or 3-hole mounting are

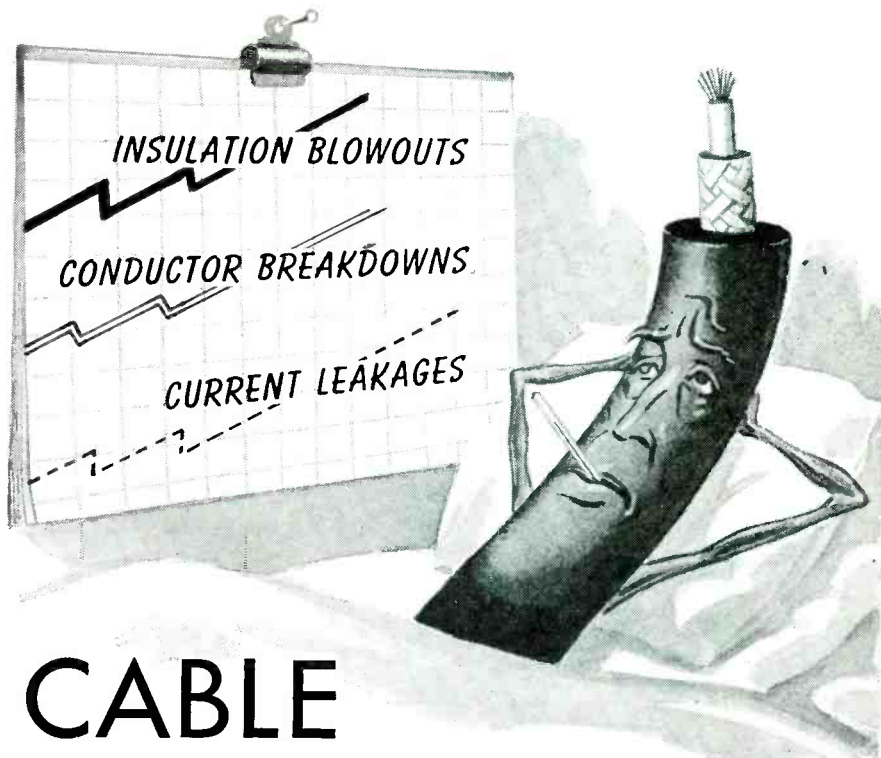

## CABLE DISEASES *are* AVOIDABLE

Synkote engineered and constructed cables are free of these ills. Long life, quality and performance are assured by ample insulation thicknesses, proper compounding, uniform and adequate conductors and constant continuity testing.

Whether it be a few or a hundred conductors, whether they be braided, wrapped, foiled, striped or jacketed you will find our engineers have the know-how requisite to the production of faultless high-quality multi-conductor cable to meet the most exacting specifications.

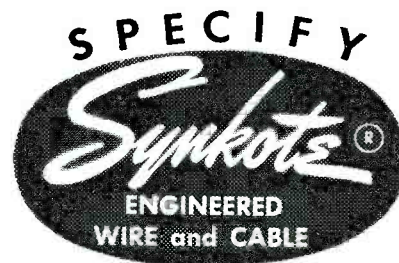
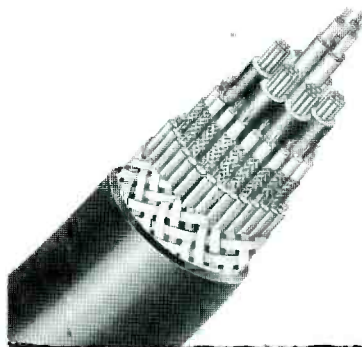

FOR SURE PERFORMANCE

# PLASTOID Corporation

Plant: HAMBURG, N. J. • Offices: 42-61 24th Street, Long Island City 1, New York

**need precision  
production help?**

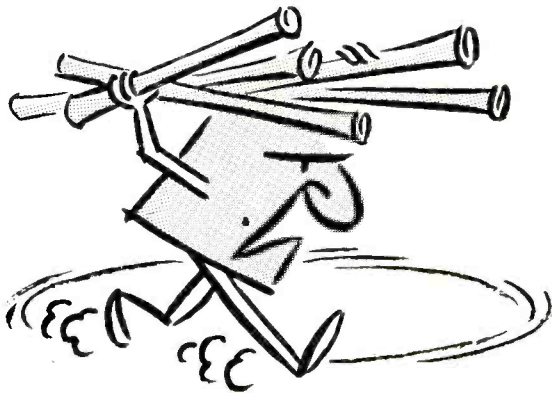

## **WALTHAM**

**can develop and make  
your miniature assemblies**

When your designs require miniature or sub-miniature assemblies in volume, Waltham facilities are the answer to your problems. At Waltham you'll find the specialized tools—many made in our own shops to meet specific needs—and the highly skilled people with long experience in operating them.

Waltham competence in precision instrumentation, as evidenced by our performance record on contracts for major producers, can be applied to your requirements ...efficiently and economically.

The same ingenuity that gave the new Waltham Vertical Gyro its superior performance characteristics can be applied to resolving the production problems facing you.

*A Waltham engineer is well qualified to talk to you about mechanical or electromechanical assemblies. Ask him to call on you—or send us your drawings and specifications.*

**WALTHAM PRECISION INSTRUMENT COMPANY**  
FORMERLY WALTHAM WATCH COMPANY

**WALTHAM 54, MASSACHUSETTS**

**PRECISION HAS BEEN OUR BUSINESS SINCE 1850**

standard; bushing mount is also available, in a case  $\frac{3}{8}$  in. deep.

Shaft diameter for both models is  $\frac{1}{4}$  in. Standard resistances are 50, 100, 200, 500, 1,000, 2,000, 5,000, 10,000, 20,000, 25,000, 40,000, 50,000 and 100,000 ohms; ranges beyond these are furnished on special order. A data sheet is available. **Circle 438 on Reader Service Card.**

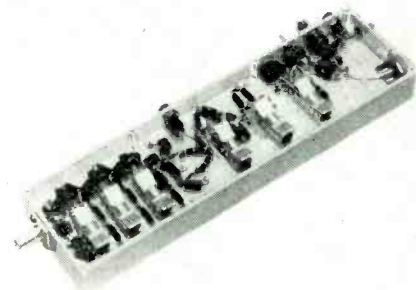

### **I-F AMPLIFIER**

afc unit

LEL, INC., 380 Oak St., Copiague, L. I., N. Y., has added a new sub-miniature afc unit to their line of missile and radar amplifiers. This unit, designed for use in a 0.1  $\mu$ sec pulse system, contains in one chassis all the elements required for afc purposes such as the i-f amplifier, diode phantatron, and an internal control for manual tuning of the LO. A sweep frequency of 3 cps and a sweep output of 45 v at an adjustable level of 115 to 195 v is also provided. Overall dimensions are  $11\frac{1}{2}$  in. by  $3\frac{1}{2}$  in. by 1 in., including controls. **Circle 439 on Reader Service Card.**

### **DUAL CHANNEL ANALYZER**

counts at 200,000 per sec

FRANKLIN ELECTRONICS, INC., Dept. 421, Bridgeport, Pa., has introduced a new dual channel pulse height analyzer which provides 200,000 counts per sec in the range of 3 to 140 v. Model 405 makes possible studies of the amplitude distribution of voltage pulses within its specified range. Providing for both integral and differ-

ential spectrum analysis, it also enables studies of energy distribution of nuclear particles when used with a linear amplifier or scaler.

Model 405 contains two completely isolated single channel pulse height discriminators operated from a regulated power supply. Pulse height zero drift is only 0.05 v per week with regulated voltage. Slit width (window) is 0 to 10 v. Dead time is 1.0  $\mu$ sec. Circle 440 on Reader Service Card.



### PRECISION POTS in 5 and 10-turn models

INTERNATIONAL RESISTANCE Co., 401 North Broad St., Philadelphia 8, Pa., has added two new precision potentiometers, types HC-100 and HC-105, to the product line of its St. Petersburg, Fla. subsidiary, Circuit Instruments, Inc.

Available in 5 and 10-turn models, these units feature side terminals, shorter internal lead length and lower end resistance. Encased in grade XX laminated phenolic with a black mirror finish, they are a slim 1 in. in diameter. Standard linearity is  $\pm 0.5$  percent.

Type HC-100 features 3,600 deg,  $-0$  deg  $+4$  deg rotation and is rated at 4 w. Its weight is 2.3 oz and standard resistance values range from 500 to 100,000 ohms. Type HC-105, which weighs only 1.8 oz, has a rotation of 1,800 deg,  $-0$  deg,  $+4$  deg and is rated at 3 w. Standard resistance values are from 250 to 50,000 ohms. Bul-

# 6000 cps

*—a new high in frequency from  
a high force vibration exciter system*

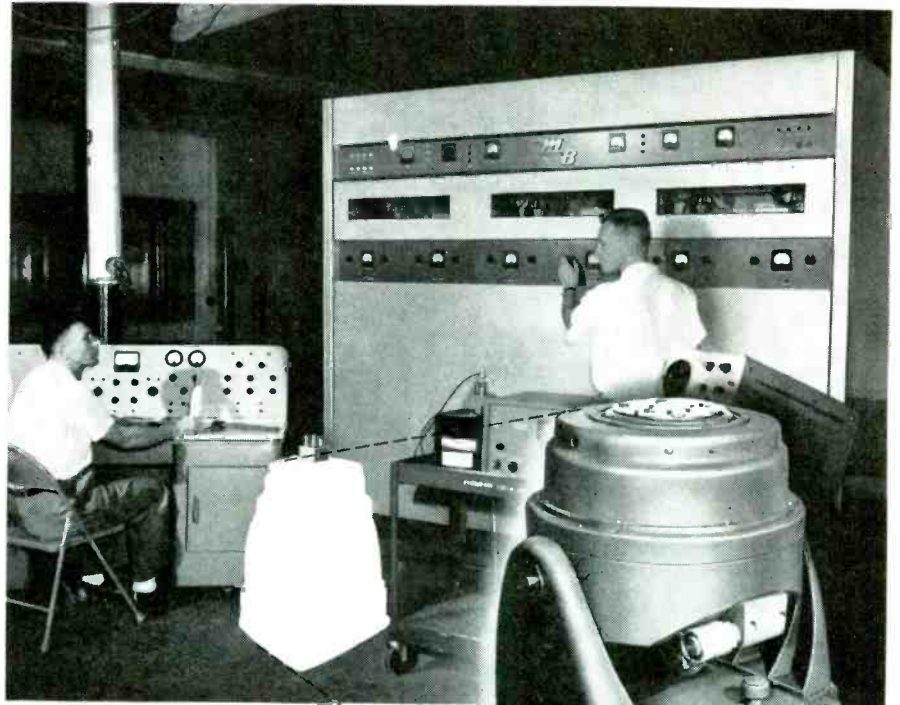

With new 6000 cps rating, the MB Model C10VB electrodynamic exciter further extends the complex motion testing range . . . yet delivers 1750 pounds force for sinusoidal testing with an MB Model T666 15 KVA amplifier (36,000 watt plate dissipation).

This is versatile equipment. With an MB T666 amplifier and TEMC control cabinet, it has the "muscle" to subject electronic products and other critical components to accelerations up to 58 "g". Adding an MB T88 Complex Motion Console equips it for duplicating the actual "noise" or random motion of the environment. This system is designed with an eye to future needs.

What's more, the exciter works in environmental test chambers,

so that vibration can be combined with heat, cold, altitude. This not only saves test time, but gives more realistic data on performance as well.

MB C10VB Exciters have UNIMODE rocker suspension (pat. pend.) which assures linear motion and a uniform spring rate over the total stroke of 1-inch (double amplitude).

Users of MB test equipment have at their call a nationwide field service organization of vibration specialists to help on application problems. Send for full data on the complete line MB Shakers.

## MB manufacturing company

A DIVISION OF TETRON INC.

1075 State Street, New Haven 11, Connecticut

HEADQUARTERS FOR PRODUCTS TO ISOLATE . . . EXCITE . . . AND MEASURE VIBRATION



# BIG-POT PERFORMANCE in Miniature-pot size

## *Waters* PRECISION MINIATURE POTENTIOMETERS

are built, tested, and certified\* to such rigid specifications as AIA, RETMA, JAN-R-19, MIL-E-5272A, and other applicable military specifications. This new line of single-turn pots packs Waters traditional performance into tight spots.

**NOW!** A complete single-turn-pot line from *Waters*

\*Complete data on request.

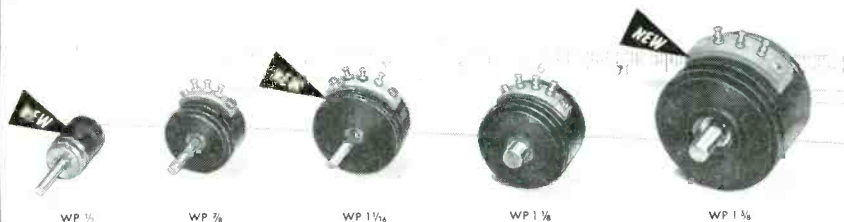

# BIG-POT PERFORMANCE in Miniature-pot size

## *Waters* ROTARY TRIMMER POTENTIOMETERS

are built, tested, and certified\* to rigid military environmental specifications and are available in many variations: ganged, tapped, with various electrical and mechanical angles, locking shafts, anti-rotation pins, "O" rings, etc.

\*Complete data on request

**NOW!** A complete single-turn-pot line from *Waters*

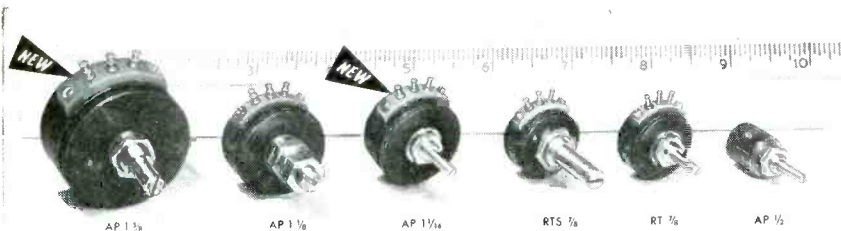

Write for catalog of the Waters complete single-turn pot line — precision, trimmer, low-torque, miniature.

**Waters**  
MANUFACTURING, inc.

APPLICATION ENGINEERING OFFICES  
IN PRINCIPAL CITIES  
Wayland, Massachusetts



NEW PRODUCTS

(continued)

letin A-5A is available. Circle 441 on Reader Service Card.

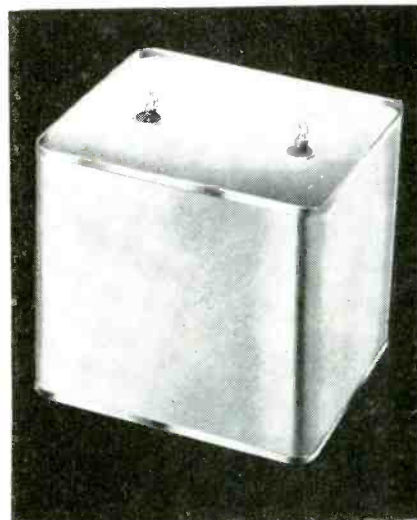

### TEFLON CAPACITORS

values from 0.001 to 10  $\mu$ f

DEARBORN ELECTRONIC LABORATORIES, 1421 North Wells St., Chicago 10, Ill., has available a comprehensive line of Teflon capacitors. This dielectric is noted for its exceptional electrical properties from  $-55$  to  $+200$  C. Minimum insulation resistance is one million megohm-microfarads at 25 C and 1,000 at 200 C. Capacitance change over the entire temperature range is less than 4 percent. Dielectric absorption is second only to polystyrene. Dissipation factor reaches a maximum of about 0.2 percent at 200 C. Capacitance values from 0.001 to 10  $\mu$ f are available in hermetically sealed metal tubes or drawn rectangular cans. Standard voltages are 200, 400 and 600. Circle 442 on Reader Service Card.

### BROADBAND ABSORBER

reflection cut down

B. F. GOODRICH SPONGE PRODUCTS DIVISION, Shelton, Conn. A 10-to-1 decrease in reflection of its standard 12CM broadband microwave absorbent material for simulating free space conditions indoors has been announced by the company.

The material is now available with a maximum of 0.1-percent reflection above 8,400 mc. This de-



crease in reflection at X-band, where most missile guidance and fire control systems operate, is designed to allow more accurate testing of such systems in indoor free-space chambers.

Other absorbers are available with a maximum of 0.1-percent reflection at lower microwave frequencies. Maximum reflection of the standard 12CM broadband absorber remains less than 1 percent from 2,500 to 8,400mc and less than 1 per cent over the same frequency range for a selected 12CM material. **Circle 443 on Reader Service Card.**

**NPN TRANSISTORS**

four new types

GENERAL TRANSISTOR CORP., Jamaica, N. Y., has available four new germanium alloyed junction transistors, types 2N444, 2N445, 2N446 and 2N447. Of the *npn* variety, these transistors are especially useful for small signal amplifier and high speed switching applications. The four units offer alpha cutoff frequencies ranging from 0.5 to 9.0 mc and small signal current gain ranges from 15 to 125.

This brings to sixty-nine, the number of different transistors commercially available from the company. **Circle 444 on Reader Service Card.**

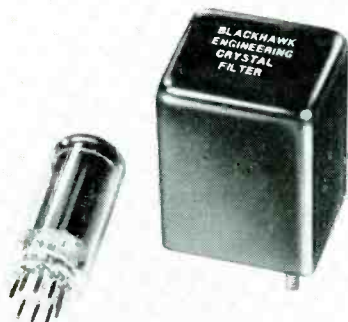

**CRYSTAL FILTER**

features miniature design

BLACKHAWK ENGINEERING, 1912 Woodruff Ave., Janesville, Wisc. Selectivity of the order attained by several cascaded double-tuned i-f stages in the 200-500 kc range

**ATTRACT AND HOLD TECHNICAL PERSONNEL**

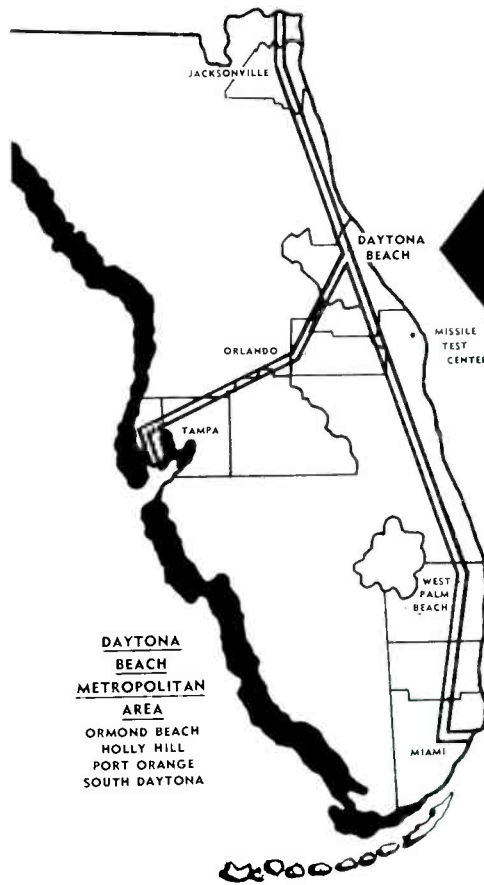

**SERVE  
FLORIDA'S  
METROPOLITAN AREAS  
FROM A  
DAYTONA BEACH  
INDUSTRIAL SITE**

Daytona Beach, the east-to-west terminal on the north-to-south route of the projected Federal Limited Access Freeway System, gives industry a *plus* for the future.

Write for new 90 page Industrial Brochure

**INDUSTRIAL DEPARTMENT  
CHAMBER OF COMMERCE  
DAYTONA BEACH, FLORIDA**

CIRCLE 204 READERS SERVICE CARD

**NOW** we can meet the demand for

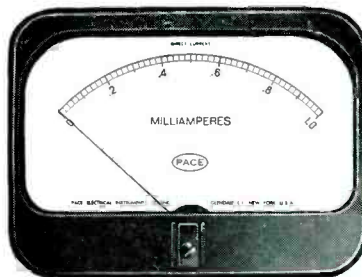

**PACE**  
THE METER OF PRECISION

**METERS!**  
2" TO 7" SIZES

Expanded plant . . . increased staff . . . New, improved automation techniques . . . to meet the demand of electronic equipment manufacturers for custom produced panel meters, in production quantities.

**PACE** meters are manufactured under rigidly controlled climatic conditions to meet critical specifications as to sensitivity, resistance, damping, response time, illumination, scaleplate design, etc.

Send for latest illustrated catalog, available upon request.  
Write, wire or phone for applications engineering, consultation and assistance!

**PACE ELECTRICAL INSTRUMENTS CO., INC.**

a Division of Precision Apparatus Co., Inc.  
70-31 84th Street, Glendale 27, L.I., N.Y.  
Export: Morhan Exporting Corp., 458 Broadway, N. Y. 13, N. Y.

**NEW  
FREQUENCY DOUBLERS**

- Double the sampling rate
- Double the band width
- Eliminate zero offsets

**DC-AC  
CHOPPERS**

Twenty-two types,  
both single and  
double pole.

Long life.

Low noise level.

Extreme reliability.

Write for Catalog.

**STEVENS  
INCORPORATED  
ARNOLD**

7 ELKINS STREET  
SOUTH BOSTON 27, MASS.

S/A-10C

CIRCLE 206 READERS SERVICE CARD

## ELIMINATE RHODIUM PLATE REJECTS!



# RHODEX

produces compressively stressed deposits

permitting heavier Rhodium electroplate than ever before possible. The photograph shows a film of Rhodium plate, produced with RHODEX, from which the basis metal was dissolved. Note the continuous unimpaired surface. We tried this experiment with leading competitive Rhodium formulations—the plate fell to pieces at a touch of the pencil. No special "know-how"—you can duplicate this demonstration in your own laboratory, with RHODEX. No cracking, no peeling...even in thickness exceeding one thousandth of an inch. Send for details.

*Precious Metals Division*

**SEL-REX CORPORATION**

Nutley 10, New Jersey

(Offices: Detroit, Chicago, Los Angeles)

Manufacturers of Exclusive Precious Metals Processes, Metallic Power Rectifiers, Airborne Power Equipment, Liquid Clarification Filters, Metal Finishing Equipment and Supplies.

has been attained in a miniature crystal filter.

Double conversion is no longer required in many communications receiver designs, since both image frequency rejection and adjacent channel selectivity may now be provided, utilizing a single i-f of 3 mc. It provides better than equivalent performance with fewer tubes.

The unit is hermetically sealed, hence environmental stability is assured. Since the response curve is crystal-controlled no tedious i-f alignment is required. Filters are also available to custom requirements in the 3 to 15 mc range. Circle 445 on Reader Service Card.

### PULSE GENERATOR

wide-range unit

BURROUGHS CORP., Electronic Instruments Division, 1209 Vine St., Philadelphia 7, Pa., has announced a new wide-range pulse generator, the type 1006.

The unit produces a stable source of pulses in eight overlapping frequency ranges up to 4.5 mc. Its output may be a continuous train of pulses controlled by selecting one of the eight frequency ranges or a single pulse controlled by pressing a pushbutton on the front panel. The output pulse is either a positive or negative half sine-wave of 0.1  $\mu$ sec duration whose amplitude is variable from 8 to 30 v. Circle 446 on Reader Service Card.



### SUBMINIATURE SWITCH with overtravel plunger

UNIMAX SWITCH, Division The W. L. Maxson Corp., Ives Road, Wallingford, Conn. Designed to provide the advantages of panel

mounting plus over-travel plunger actuator, along with the small size of a subminiature switch, the USMJ-1 switch mounts in a 1/4-in. hole and fits into back-of-panel area only 3/8 in. long by 3/8 in. wide. Solder-lug terminals, located on the rear of the switch, handle wires up to No. 18.

This actuator can be furnished with any basic USM Unimax switch. The type USMJ-1 is designed to meet commercial standards. The type USM3J-1 is designed for high-temperature applications—up to 275 F. Type USM5J-1 is designed to meet Military Specification MIL-S-6743.

Electrical ratings are 2 1/2 amperes 30 v d-c, inductive; 4 amperes 30 v d-c, resistive; 5 amperes 125/250 v a-c. Circle 447 on Reader Service Card.



**PRECISION POT**

miniature, single-turn

SPECTROL ELECTRONICS DIVISION OF CARRIER CORP., 1704 South Del Mar Ave., San Gabriel, Calif., announces an improved version of their standard 1/8 in. diameter, single-turn model 700.

With high-quality toroidal coils, the 700 is now available with resistance values up to 125,000 ohms and ±0.2 percent linearity. This precise miniature incorporates, with its increased range, all aluminum construction—up to 6 sections ganged on a single shaft—with class 5 ball bearings at both ends—first pot section 0.687 in. long and each additional cup only 0.500 in. in length.

All terminals are glass insulated, steel sheathed, gold plated and permanently locked-in. Nine additional terminals are available

# DIRECTIONAL COUPLERS

**VSWR and RF POWER MEASURING EQUIPMENT**

New Products included in new Catalog No. 12 create the most extensive line available.

**RF POWER and VSWR INSTRUMENTS**



Model No.	Frequency Range (mcs.)	Power Range Incident & Reflected (watts)	RF Connectors and Impedance
261**	0.5 - 225	0 - 1000	Type 83-1R 52 ohms
262	-	0 - 1000 (relative)	Indicator only
263	0.5 - 225	0 - 10; 100; 1000	Type N* 52 ohms
702N	28 - 2000	0 - 4	Type N* 52 ohms
703N	20 - 2000	0 - 12	Type N* 52 ohms
▲705N	20 - 2000	0 - 120	Type N* 52 ohms
▲706N	28 - 2000	0 - 400	Type N* 52 ohms
711N	25 - 1000	0 - 30; 75; 300	N plus 83-1R Adapters
▲722N	1000 - 3000	0 - 4	Type N 52 ohms
▲723N	1000 - 3000	0 - 12	Type N 52 ohms
405B8	28 - 2000	0 - 4000	1 1/2" Flange 51.5 ohms
445A9	28 - 2000	0 - 12,000	3/4" Flange 50.0 ohms
445A10	20 - 2000	0 - 40,000	3/8" Flange 50.0 ohms

**DC OUTPUT DIRECTIONAL COUPLERS**

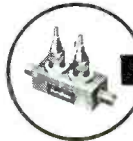

Model No.	Frequency Range (mcs.)	Power Range Incident & Reflected (watts)	RF Connectors and Impedance
576N1	42 - 2000	1.2	Type N* 52 ohms
576N3	20 - 2000	0 - 12	Type N* 52 ohms
▲576N4	46 - 2000	0 - 40	Type N* 52 ohms
576N6	28 - 2000	0 - 400	Type N* 52 ohms
▲592N	1000 - 3000	0 - 4	Type N 52 ohms
▲593N	1000 - 3000	0 - 12	Type N 52 ohms
402B8	28 - 2000	0 - 4,000	1 1/2" Flange 51.5 ohms
442A9	28 - 2000	0 - 12,000	3/4" Flange 50.0 ohms
442A10	20 - 2000	0 - 40,000	3/8" Flange 50.0 ohms

**RF OUTPUT DIRECTIONAL COUPLERS**

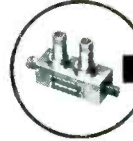

Model No.	Frequency Range (mcs.)	Coupling Attenuation	RF Connectors and Impedance
313N3	300 - 2000	30 db	Type N* 52 ohms
313N4	120 - 2000	40 db	Type N* 52 ohms
313N5	60 - 2000	50 db	Type N* 52 ohms
313N6	30 - 2000	60 db	Type N* 52 ohms
▲442A40	200 - 1000	40 db	3/4" Flange 50.0 ohms

**ABSORPTION TYPE RF WATTMETERS**



Model No.	Frequency Range (mcs.)	Power Range (watts)	RF Connectors and Impedance
621N	1 to over 1000	0 - 120 milliwatts	Type N* 52 ohms
▲624N	1 to over 1000	0 - 4	Type N 52 ohms
625C5	50 - 1000	0 - 120	Type C 50 ohms
▲651N	25 - 1000	0 - 25; 100; 500	Type N 52 ohms
▲611A7	50 - 1000	0 - 1200	3/4" Flange 50 ohms
612A	44 - 1000	0 - 6000	3/4" Flange 50 ohms

**RF LOAD RESISTORS**



Model No.	Frequency Range (mcs.)	RF Power Dissipation (watts)	RF Connectors and Impedance
633N	3000	50 (air cooled)	Type N* 52 ohms
635N	3000	200 " "	Type N* 52 ohms
636N	3000	600 " "	Type N* 52 ohms
636A	2000	600 " "	3/4" Flange 50.0 ohms
638A	2000	6000 (water cooled)	3/4" Flange 50.0 ohms

**CALORIMETRIC TYPE Primary Standard of RF Power**



Model No.	Frequency Range (mcs.)	Power Range (watts)	RF Connectors and Impedance
641N	0 - 3000	0 - 3; 10; 30; 100; 300	Type N 52 ohms

▲New products

\*Also available with UHF, C, and HN Connectors.  
\*\*Coupler Unit Only for use with 262 Indicator.



**M. C. JONES ELECTRONICS CO., Inc.**  
BRISTOL, CONNECTICUT

INSTRUMENT AND COMPONENT

**SALES REPRESENTATIVES**

High quality manufacturer of electronic test instruments, associated equipment and components seeks energetic sales representatives, particularly in the following areas:

- Baltimore - Washington
- Atlanta - Birmingham
- St. Louis - Kansas City
- Minneapolis
- Pittsburgh
- Cleveland
- Detroit
- Florida

Preference will be given to conscientious and enthusiastic organizations with good contacts and ability to interpret market requirements. We back up your efforts with strong merchandising and liberal commissions.

Write us your qualifications and present commitments.

**TRANSITRON inc.**

Division of Van Norman Industries, Inc.  
 186 Granite Street, Manchester, N. H.  
 Attn: Director of Sales and Marketing



CIRCLE 209 READERS SERVICE CARD

per section—taps at nearly any angle of the coil, and tap-welded to a single turn of the resistance wire. Circle 448 on Reader Service Card.

**DIGITIZER**

a multipurpose unit

FRANKLIN ELECTRONICS, INC., Bridgeport, Pa., has developed a new all-electronic digital voltmeter for making precision voltage measurements from 0 to 120 v d-c. Called the model 310 A, this multipurpose digitizer is ideal for laboratory and production measuring. It can also be used as the essential analog to digital conversion element in data reduction systems.

This low-cost instrument provides accuracy of 0.1 percent of full scale and readings at a rate of 60 per sec—automatically or on command. Measurements are displayed on the front panel via 4 clearly illuminated decimal digits (000.0 to 120.0). Coded outputs of each significant figure in the visual readout provide a signal source to operate matrices, punched or categorizing equipment. Circle 449 on Reader Service Card.

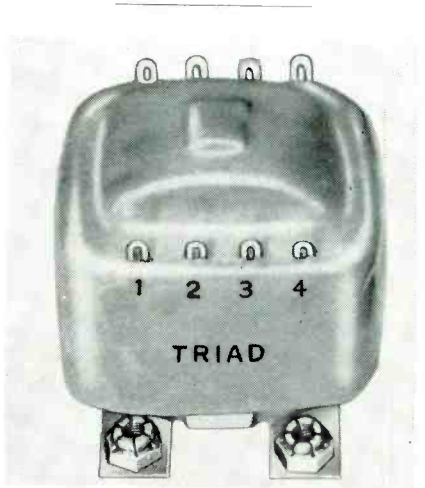

**TRANSFORMERS**

with long life expectancy

TRIAD TRANSFORMER CORP., 4055 Redwood Ave., Venice, Calif., announced recently that most of its transformer types can now be supplied in versions designed to exceed the requirements of MIL-T-27A specification, Class S. This

## HIGH VOLTAGE

## POWER SUPPLIES

**MODEL LAB-60 RF TYPE**  
 Continuously Variable 0-60 KV DC Regulated Power Supply  
 Current output 1 ma. at 60 KV. 2 ma may be drawn from 50 KV to 0. Supplied with either positive polarity or negative polarity output. Regulation stability—1% at 1 ma 2 1/4" wide x 2 2/4" high x 1 1/8" deep.  
 LAB-60 Complete with meter. . . . . \$695.00 Net  
 LAB-60 PN Reversible polarity model of above . . . . . \$745.00 Net

**MODEL 457 4 1/2 KV POW. SUPPLY**  
 Utilizes two 6X4 tubes as a parallel feeding a 1X2 tube. For a voltage of DC at 1 ma varied from 1 KV to 7 1/2 KV. Dimensions: 5 1/2" high x 5" deep x 4 1/4" wide. In completely enclosed metal housing (not shown). Less low voltage DC supply \$32.50 Net

**MODEL 2040 40 KV DC Power Supply**  
 In constant use in laboratories and industrial plants throughout the world for condenser charging, electrostatic spraying and stress testing, etc. Available with either positive or negative 40 KV output. Voltage range of approx. 15 to 40 KV. The 15 to 40 KV variance in voltage is controlled through a knob on the front panel. If required for TV use, a voltage output of approx. 4 to 6 KV is available through a tap. Voltages supplied through a 4 ft. HV Safety Cable. 19 1/2" wide x 12 1/2" high x 1 3/8" deep.  
 Specify desired polarity when ordering. . . . \$150.00 Net  
 With HV meter installed in front panel. \$50 additional

**MODEL RG-30—Continuously Variable 15-30 KV Regulated DC Power Supply**  
 with regulated focus  
 Incorporates a voltage tap in the range of 4 to 6 KV for use with 5WP15, 5TP4 and flying spot tubes. Regulations better than .5% at 1 milliampere. In wide use for color tube development work, transcription recording systems. Also available with focus and convergence voltage taps for RCA Tri-Color tubes at slight additional cost. This model can be adjusted for 40 KV output at .5 milliampere for new 40 KV projection tubes.  
 19 1/2" wide x 12 1/2" high x 1 3/8" deep . . . . . \$295 Net  
 With meter installed on front panel . . . . . \$345 Net

COMPLETE LINE OF HIGH VOLTAGE COILS—Send for complete catalog E

**TELEVISION CO., INC.**

**3029 WEBSTER AVENUE**  
 N. Y. 67, N. Y.  
 Kingsbridge 7-0306

specification covers transformers and inductors with life expectancies of greater than 10,000 hours, and operating conditions from  $-50^{\circ}\text{C}$  to  $130^{\circ}\text{C}$ .

These new 130 C transformers cost only slightly greater than Class R (105C) types. They are also available to customer specification on special order. Circle 450 on Reader Service Card.

## LIMIT SWITCHES

preadjustable, snap-action

TECHNOLOGY INSTRUMENT CORP. OF CALIFORNIA, 7229 Atoll Ave., North Hollywood, Calif., has available a conveniently packaged pair of rugged snap-action limit switches for attachment to a 1-in. pot.

Outstanding features of the switch are its range of angles from 0 to  $360^{\circ}$  and the fact that the switch can be preadjusted to actuate over this range of angles. Also of interest is the operating torque at switch action points of 3.5 in. oz (max) and running torque of 0.5 in. oz (max).

The switch action is extremely compact, requiring approximately  $\frac{1}{2}$  in. additional length and on a 1-in. potentiometer gang.

Fully illustrated material and complete information covering mechanical and electrical specifications are available. Circle 451 on Reader Service Card.

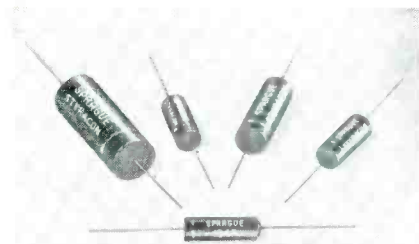

## CAPACITORS

polystyrene film type

SPRAGUE ELECTRIC Co., North Adams, Mass., has announced the type 194P Styracon capacitors. They use an especially processed polystyrene film for their dielectric. They are protected against moisture as well as mechanical



he's working  
for you

THIS FELLOW IS TRAINED IN YOUR BUSINESS. His main duty is to travel the country — and world — penetrating the plants, laboratories and management councils . . . reporting back to you every significant innovation in technology, selling tactics, management strategy. He functions as your all-seeing, all-hearing, all-reporting business communications system.

THE MAN WE MEAN IS A COMPOSITE of the editorial staff of this magazine. For, obviously, no one individual could ever accomplish such a vast business news job. It's the result of many qualified men of diversified and specialized talents.

AND, THERE'S ANOTHER SIDE TO THIS "COMPOSITE MAN," another complete news service which complements the editorial section of this magazine — the advertising pages. It's been said that in a business publication the editorial pages tell "how they do it" — "they" being all the industry's front line of innovators and improvers — and the advertising pages tell "with what." Each issue unfolds an industrial exposition before you — giving a ready panorama of up-to-date tools, materials, equipment.

SUCH A "MAN" IS ON YOUR PAYROLL. Be sure to "listen" regularly and carefully to the practical business information he gathers.



McGraw-Hill PUBLICATIONS

# WHO IS BORG?

George W. Borg, who founded this corporation, is the "Mr. Clutch" who started with Borg & Beck. He then helped organize the Borg-Warner Corporation of which he became president. Later he served as chairman of the board until he resigned to devote his full attention to The George W. Borg Corporation.

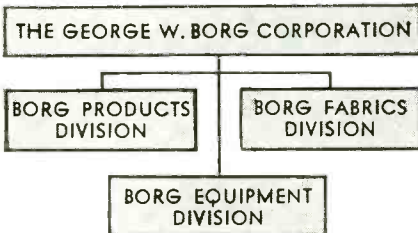

The George W. Borg Corporation is comprised of three divisions

- **Borg Products Division**  
Manufactures automotive clocks.
- **Borg Fabrics Division**  
Manufactures deep-pile fabrics best known of this line is the fashionable "Borgana" fabric.
- **Borg Equipment Division**  
Manufactures Micropots (precision potentiometers), Microdials (precision turn-counting dials), instrument motors, frequency standards, aircraft navigational instruments and components for systems.

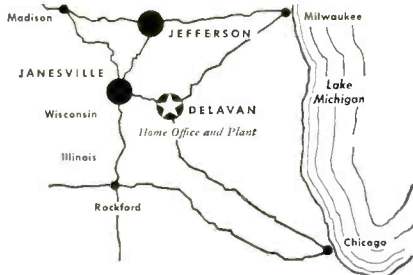

## HOW BORG EQUIPMENT DIVISION CAN HELP YOU . . .

Borg's background of experience will save you time and money by helping you solve design and production problems of electronic components. Whether you are faced with a special problem or interested in a standard component, call Borg Equipment Division for an economically sound solution. Write today for catalog BED-A56.



**BORG EQUIPMENT DIVISION**  
THE GEORGE W. BORG CORPORATION  
JANESVILLE, WISCONSIN

CIRCLE 211 READERS SERVICE CARD

damage in installation by pre-molded mineral-filled phenolic shells with resin end seals, thus overcoming poor field experience with wrapped-type designs.

The extremely high Q, minimum dielectric absorption, and high insulation resistance of type 194P capacitors make them most suitable for applications in tuned circuits, timing and integrating circuits, and in inter-stage coupling networks in high quality amplifiers. Because they approach an ideal capacitor in their electrical characteristics, they also make good working standards for school and college electronics laboratories. **Circle 452 on Reader Service Card.**

degree of accuracy than heretofore possible. When used in combination with a model 1002 decoder, it becomes possible to solve problems in telemetering, analog computation, digital computation, pcm, and many other data processing applications. **Circle 453 on Reader Service Card.**



### METAL FILM RESISTOR

cannot burn up, short out

THE DAVEN Co., Livingston, N. J., has available the Davohm series 850 hermetically sealed metal film resistors, specifically designed to negate the possibilities of shorting out or burning up. There are no organic compounds in the resistor which might carbonize. The series 850 are extensively used in critical applications where severe line overloads might burn up conventional resistors or cause them to short out and overload other components. Typical present applications include fuel gages in jet planes and line terminations in telemetering circuits.

This series offer the lowest noise level available, low ohmic values, excellent high frequency characteristics, a wide temperature range and complete hermetic sealing in smallest size. **Circle 454 on Reader Service Card.**

### MOLDED CHOKE COILS with radial leads

DELEVAN ELECTRONICS, East Aurora, N. Y., has introduced a complete series of 42 radial lead coils. Inductance values range from 0.47 to 10,000  $\mu$ h. All other values are exactly defined for easy engineering evaluation. Each coil is hermetically encapsulated in molded alkyd plastic making it



FRONT VIEW OF AVION ANALOG-TO-DIGITAL CONVERTER TYPE NO. 525

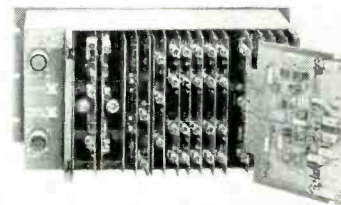

REAR VIEW—WITH COVER REMOVED SHOWING TYPICAL PRINTED CIRCUIT BOARD

### ENCODER

all-electronic converter

AVION DIVISION ACF INDUSTRIES, INC., 800 North Pitt St., Alexandria, Va., has introduced the new type 525 encoder (analog to digital converter). It is an all-electronic converter designed to provide precise and dependable conversion of analog input data to digital output voltages. Particular emphasis is placed upon accuracy and resolution. Dependable operation is maintained over a wide range of environmental conditions. The 525 encoder makes possible the use of versatile, noise-free digital transmission and computing techniques to a greater

possible for all coils to easily conform to MIL-C-15305A specifications.

There is a "Flat" base molded in the body of each coil at the lead exit to permit snug and secure placement of coils on printed circuit boards. The radial leads are suitable for either automation equipment or hand insertion. Leads are spaced at 0.100 in. increments for customer's convenience.

The 42 radial lead coils range in size from 0.235 in diameter and 0.625 in length to 0.500 in diameter and 0.825 in length with 5 different mold sizes available. **Circle 455 on Reader Service Card.**

### TOGGLE SWITCHES

single and double pole

ALLIED CONTROL Co., INC., 2 East End Ave., New York 21, N. Y., has added to its line of components a group of subminiature toggle switches formerly manufactured by Miniature Switch Corp. This line of switches is especially suited for use in printed circuits, transistorized and other miniaturized electronic equipment for the Military.

The body of the single pole type measures 0.520 by 0.270 by 0.320; the double pole type, 0.520 by 0.520 by 0.320. Dielectric is 1,000 v rms; vibration is 10 g 10-500 cps. They meet shock specifications MIL-S-901 (type C). **Circle 456 on Reader Service Card.**

### TEFLON WIRE

has improved color coding

WIRECRAFT PRODUCTS, INC., 10 Lake St., West Brookfield, Mass. Improved color coding of Teflon tape insulated wire can now be obtained by new techniques developed for spirally wrapping two different colored strips on white or colored backgrounds. The two different colored strips of two different widths are so applied that the background color is always visible between them. The first stripe is applied twice the width of the second stripe and the background

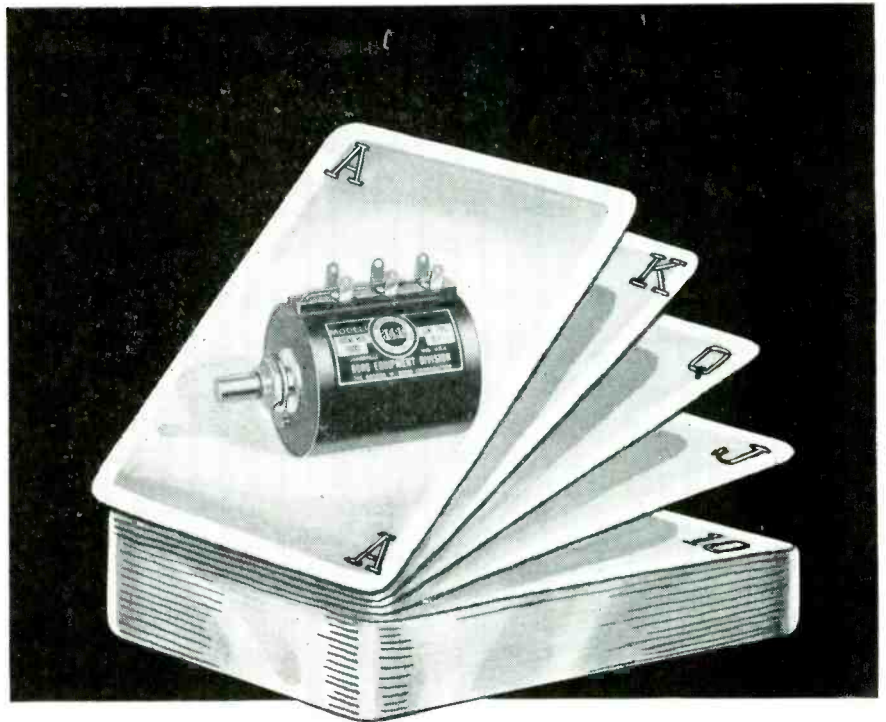

## SELECT THE ACE OF COMPETITIVE POTENTIOMETERS . . .

### *Borg 1100 Series Micropots!*

Now! Mass-produce your precision equipment products with price advantages in your competitive markets! Borg 1100 Series MICROPOTS give you quality potentiometers at a competitive price. Cut down high production costs that are "stacking the deck" against you. Write for the name of your nearest Borg Jobber or "Tech-Rep" today!

### 1100 SERIES MICROPOT ADVANTAGES . . .

1. Lug-type terminals or coded flexible leads 9" long.
2. Optional rear shaft extension on single and ganged assemblies.
3. Precision, interchangeable parts give permanent accuracy.
4. Engineered for easy installation . . . long-lasting service.
5. Interchangeable Borg MICROPOTS permit maximum flexibility.
6. Two bearing supports . . . 1½" maximum between bearings.
7. Simplicity of construction . . . fewer parts minimize servicing.
8. Production quantities available.

Write for complete engineering data — Catalog BED-A56

**BORG EQUIPMENT DIVISION**

**THE GEORGE W. BORG CORPORATION**

JANESVILLE, WISCONSIN



*Built by Borg*  
MOTORS  
MICROPOTS  
MICRODIALS

**PRECISION  
PAPER  
PART  
PROBLEMS?**

**— NIEMAND BROS.  
have the ANSWERS!**

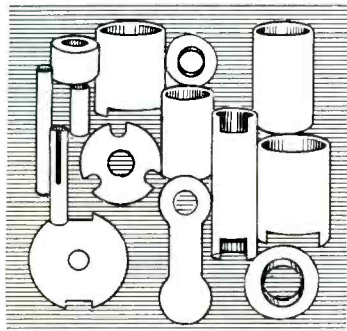

Many manufacturers have found the answers to problems of reducing unit costs and speeding up production by using Niemand Bros. Paper Tubular Products.

They're practical—buy them in the quantities you need in the materials you want—high dielectric kraft, fish paper, foils, special protective coated and laminated papers and Mylar\*. Printed or plain, they're made in diameters from .093" to 2" and up.

And, also available from Niemand Bros. are precision drawn paper or Mylar\* caps in diameters from .141" to 2", as well as die cut washers and custom parts.

\*DuPont's reg. trade mark for its polyester film.

Send for  
complete details.

**NIEMAND  
BROS., INC.**  
37-03 THIRTY-FIFTH AVENUE  
LONG ISLAND CITY 1, N. Y.

*Specialists in Paper Tubes  
Products for Electrical Applications*

RAvenswood 8-0909

CIRCLE 213 READERS SERVICE CARD

spacing between the stripes is controlled to give maximum legibility.

Spiral stripes are wrapped as an integral part of the insulation and are clear and vivid in color, non-fading, and permanent under all conditions.

The background between the last stripe of one group and the first stripe of the next is always wider than the background color between the stripes. This improved striping method makes each wire more readily distinguishable even in the most complicated circuitry where the reverse use of the same color combinations cannot always be avoided. **Circle 457 on Reader Service Card.**



**R-F AMPLIFIERS**  
for tv signal distribution

WESTBURY ELECTRONICS, INC., 300 Shames Drive, Westbury, N. Y., has announced the addition of two new r-f amplifiers to their line of tv distribution system equipment. Both units feature high gain, low noise input, excellent linearity of response providing clear, snow-free tv pictures of high quality for a large number of tv receivers from a single antenna. They are available in two models: ABB-3 channels 2 to 6, or the all band model ABB-4 (illustrated) for channels 2 through 13. **Circle 458 on Readers Service Card.**

**TRANSMITTER**  
is fully transistorized

GENERAL ELECTRIC Co., Syracuse, N. Y. A new carrier-current transmitter, fully transistorized for improved performance, is now being furnished. Designated as type CT-50B, the new unit supersedes

GE's type CT-20 transmitter, which has been widely used to transmit frequency-shift signals for impulse and frequency tele-metering, automatic dispatching, remote station supervisory control and transferred tripping.

The new transmitter is crystal-controlled and can be operated on any specified frequency from 30 to 200 kc. The operating frequency is stabilized because the two oscillators used have similar temperature — stability characteristics. **Circle 459 on Reader Service Card.**



**D-C POWER SUPPLIES**  
in 16 basic models

BETA ELECTRIC DIVISION OF SORENSON & Co., INC., 333 E. 103 St., New York 29, N. Y., is now offering a new line of rack-mounting h-v d-c power supplies, the series 1000. Available in 16 basic models with outputs from 0-1 to 0-50 kv at from 2 to 500 ma, the series 1000 features rugged construction, moderate price, conservative design, complete self-protection, and minimum operational hazards.

Typical of the series is the model 1050-5. This unit has a range of 0-50 kv at 0-5 ma, 1 percent ripple, 6 ma fixed overload, 40 percent regulation, and 420 va input at 117 v. It has a 21 in.-high panel and weighs 125 lb (with oil). The 1050-5 is also available in a more elaborate version for research and development work. In the latter version it has fine control of h-v output to approximately 0.03 percent of maximum, triple range load current and output voltage meters with scale ratios approximately 1:3:10, zero start normal with bypass button for sudden application of high voltage, and an



overload relay with trip adjustable from 20 to 120 percent of rated current. Circle 460 on Reader Service Card.



**POWER SUPPLY**  
for many applications

ALFRED ELECTRONICS, 897 Commercial St., Palo Alto, Calif., announces the new 175 to 3,500 v at 0 to 25 ma precision power supply, model 218A. Voltage is adjusted with a 10 turn pot and is resettable to  $\pm \frac{1}{2}$  percent. Line regulation is 0.003 percent and 0 to full load regulation is 0.006 percent of full scale. Extreme long and short term stability is provided; the drift specification is 0.1 v or 0.01 percent (whichever is greater) per hour and 0.02 percent for eight hours. Ripple voltage is less than 20 mv peak to peak. Also available with similar voltage and operating characteristics are 50 ma, 100 ma and 150 ma supplies.

The supplies are flexible high voltage sources for a variety of measurements involving: ionization counters, klystrons, traveling wave tubes, backward wave oscillator tubes and photomultiplier tubes. Circle 461 on Reader Service Card.

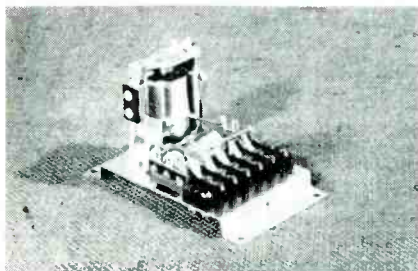

**RELAY SUBASSEMBLY**  
powered by magnetic pickup

ELECTRO PRODUCTS LABORATORIES, INC., 4500 N. Ravenswood Ave., Chicago 40, Ill., announces a new,

**IMMEDIATE DELIVERY**

(Small Quantity)

**P**RECISION **C**ARBON **D**EPOSITED **R**ESISTORS

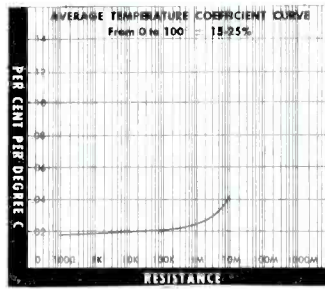

Temperature coefficient characteristics for ALPT-1 watt resistor

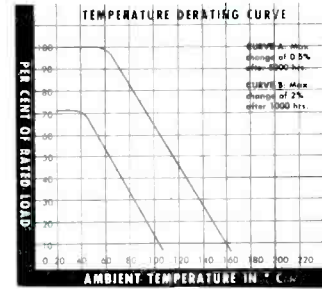

Derating curve for ALPT-1 watt resistor

STANDARD RESISTORS  $\pm 1\%$  TOLERANCE IN 10% RMA VALUES FROM 10 OHMS TO 2.7 MEGOHMS

APST- $\frac{1}{2}$  WATT, APXT- $\frac{1}{2}$  WATT AND APCT-1 WATT  
SALES OFFICES AND DISTRIBUTORS

Factory Delivery, other than stock values:  
1/10, 1/5, 1/4, 1/2, 1, 2 and 5 Watt

**ALLIES' PRODUCTS CORPORATION**  
P. O. Box 188, Kendall Branch, Miami, Florida

BROCHURE SUPPLIED UPON REQUEST.

CIRCLE 214 READERS SERVICE CARD

**Brew Delay Lines**

Brew will meet your requirements for . . .

- performance
- price
- delivery

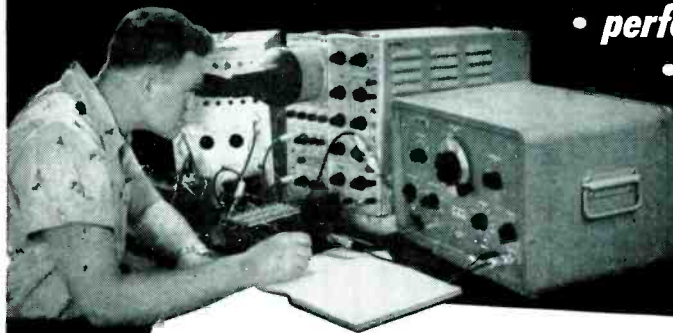

**distributed constant, lumped constant, ultrasonic**

Advanced engineering and production techniques, most modern laboratory and test equipment, and large scale manufacturing facilities enable Brew to meet your most exacting delay line requirements. Here at Brew you have the *one source* for Distributed Constant, Lumped Constant, and Ultrasonic Delay Lines, and here you benefit from the expert knowledge, experience, and *complete cooperation* of one of the pioneer delay line manufacturers.

Available covering an extremely wide range of characteristics. Meet MIL Specs. *Send us specifications on your requirements.*



**Richard D. BREW and Company, Incorporated**

Concord, New Hampshire  
design

development

telephone: CApitol 5-6606  
manufacture

# ANNOUNCING

## the DYNAMIC DIODE TESTER

by **TECHNITROL**

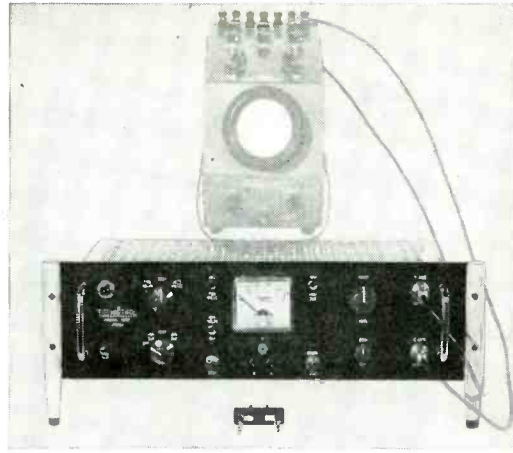

This moderate-price instrument provides an invaluable means for the rapid, accurate checking of semiconductor diodes for instability and irregularities. The dynamic curve, far more revealing than static testing, is quickly apparent on a scope screen, and is readily adapted to volume testing. In addition, the easy portability of this 16-pound instrument makes

it ideal for field work as well as bench or rack installation.

Designed for use with a D.C.-coupled oscilloscope, the Technitrol Diode Tester provides for a variety of back and forward voltages, as well as independently-controlled ranges for back and forward currents.

#### CALIBRATED RANGES:

- Forward voltage ..... 0—5 v.
- Back voltage ..... 0—100 v.
- Forward current ..... 0—50 ma.
- Reverse current ..... 0—1 ma.



CIRCLE 216 READERS SERVICE CARD

# RIBBONS · STRIPS

- of
- ★ PURE TUNGSTEN
  - ★ THORIATED TUNGSTEN
  - ★ MOLYBDENUM
  - ★ SPECIAL ALLOYS

and OTHER METALS

IN

## ULTRA THIN SIZES

to

TOLERANCES CLOSER THAN COMMERCIAL STANDARDS  
by

### OUR SPECIAL ROLLING TECHNIQUE

Note: for highly engineered applications—strips of TUNGSTEN and some other metals can be supplied

### ROLLED DOWN TO .0003 THICKNESS

- Finish: Roll Finish—Black or Cleaned
- Ribbons may be supplied in Mg. weights if required

### For HIGHLY ENGINEERED APPLICATIONS

DEVELOPED AND MANUFACTURED BY

# H. CROSS CO.

15 BEEKMAN ST., N. Y. 38, N. Y.  
TELEPHONE: WOrth 2-2044  
COOrlandt 7-0470

### TRANSISTOR TESTER

for lab and routine inspection

STRAND ENGINEERING Co., 1354 N. Main St., Ann Arbor, Mich., announces an instrument for rapid evaluation and testing of *npn* and *pnp* power transistors at their normal operating power. Model 102 power transistor tester is designed both for laboratory use and for routine inspection by shop personnel. It measures (1) collector current for zero emitter current at base-collector voltages from 0 to 75 v; (2) large signal current gain at collector currents up to 2.0 amperes, collector voltages from 0 to

compact relay subassembly designed as a safety device for machine tool builders. The device, model 3420, operates as an over or under speed control.

The relay requires no external source of power other than that generated by a power type magnetic pickup. The pickup consists of a magnet with a coil of wire surrounding it, and acts as a miniature generator when placed near the teeth of a gear.

A typical application would be a 12 tooth 8 pitch ferrous gear with the power type pickup mounted at 0.005 in. spacing. At a peripheral speed of 250 in. per sec, the speed control relay would close with the power generated.

Critical speed for the relay is set by adjusting spacing between the magnetic pickup and actuating metal. The over/under speed control relay is spdt with contacts rated at 5 amperes noninductive load. Circle 462 on Reader Service Card.

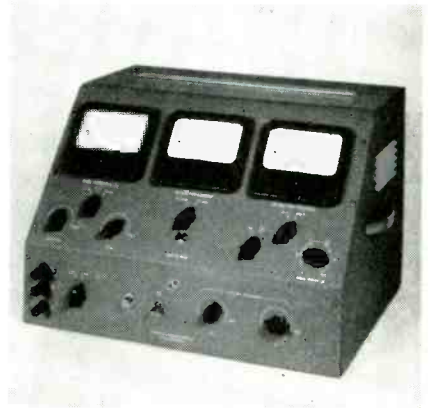

# PROTECT YOUR COMPONENTS

ELIMINATE HOT SPOTS

## VENTILATED RELAY RACK CABINETS

MIL Spec Quality  
Complete Package  
Modular Construction

Fully Controlled  
built-in  
Cross-ventilation  
System

Cool Exactly  
Where Needed

Cool Heat Load  
of 2-3 KW Input

Proven in  
4 Years' Operation  
in Government  
Laboratories

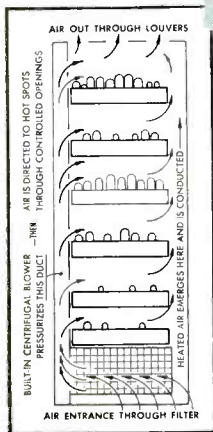
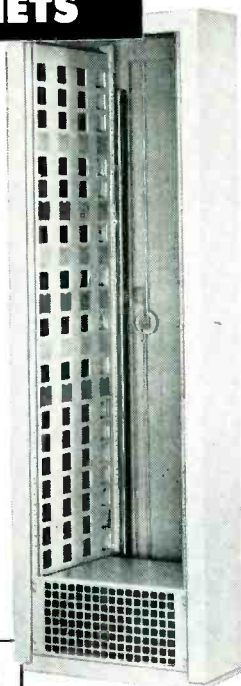

MODEL FC1-24V-68 1/4 H

Dolly Optional

STANDARD UNITS:  
19" to 24" Panels  
18" to 36" Deep

Matching Consoles  
Available

OTHERS TO YOUR  
SPECIFICATIONS

NOTE:  
Adjustable air-flow  
pattern to your  
exact needs is  
effected by snap-in  
closures—no  
'chimney' effect

- Available in cabinets or consoles —with 12-gauge or 3/16" steel frame
- Adjustable interior rails afford ready mounting for chassis slides
- Front and rear doors with glass panels or cutouts • Paint finish to customer requirements

Write for Complete Data: Series FC/E

### ONE SOURCE...

for VENTILATED RELAY RACK CABINETS, CONTROL CONSOLES, BLOWERS, CHASSIS, 'CHASSIS-TRAK', RELATED COMPONENTS

ORchard 4-3510

## WESTERN DEVICES, INC.

600 W. FLORENCE AVE., INGLEWOOD, CAL.

\*For Inquiries on 'Chassis-Trak' East of Rockies: Chassis-Trak Corp., Indianapolis

CIRCLE 218 READERS SERVICE CARD

ELECTRONICS — December 1, 1957

NEW PRODUCTS

(continued)

28 v and base currents up to 50 ma; (3) small signal current gain in the grounded emitter connection at any chosen operating point; and (4) collector-base breakdown voltage.

Measurements may be made over a wide range of operating conditions, with minimum heating, and the controls are arranged for quick, simple setup. Three five-way binding posts permit connecting transistors of all types; and adapters can be furnished for plug-in connection. Circle 463 on Reader Service Card.

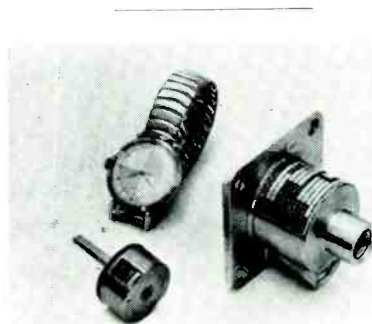

### VANE PUMP CARTRIDGE for electronic drive

VICKERS INC., Detroit 32, Mich. To meet small-space, low-weight specifications for electronic applications, the company has announced the miniaturization of the vane type pump cartridge. It weighs only 2.5 oz and will deliver 1.04 gpm at 1,000 psi and 10,000 rpm. It has an output of 0.06 hp, and is less than 1 1/8 in. in diameter.

The cartridge is available either singly or stacked for incorporation into user's housing or Vickers will furnish suitable housings. Suggested uses are: small radar drives, small computer drives and cooling for electronic chassis or missile skin. Circle 464 on Reader Service Card.

### RELAY TESTER priced at \$195

ZEUS ENGINEERING CO., INC., 635 South Kenmore Ave., Los Angeles 6, Calif. Simple relay tester, model 15B, is designed for instantaneous go, no-go test for single pole to 6 pdt relays. Coil excitation is

# PRECISION ENGINEERED Sub-Miniature Pilot Lights

... facilitate the solution of miniaturization problems.

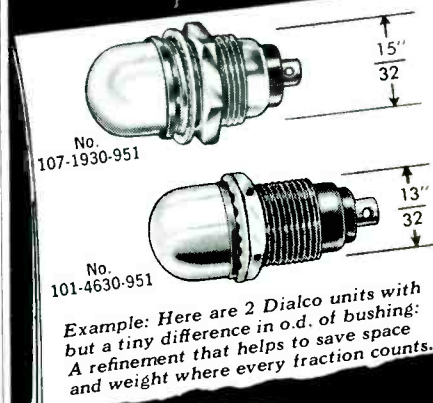

On your next miniaturization project, consult DIALCO for the Pilot Lights. You will quickly find the proper unit for use with either tiny Incandescent bulbs (T-1 3/4); or with sub-miniature Neon bulbs (NE-2D).

TWO-TERMINAL units are fully insulated. SINGLE-TERMINAL units are for use on grounded circuits. Also DIMMING or NON-DIMMING sub-miniatures for every requirement. Meet all applicable Military Specifications.

Samples for design purposes on request at once — no charge.

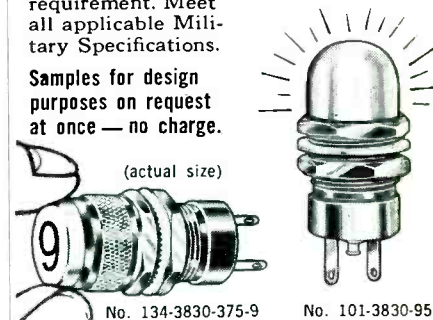

Foremost Manufacturer of Pilot Lights  
**DIALIGHT CORPORATION**

58 STEWART AVE., BROOKLYN 37, N. Y.  
HYacinth 7-7600

Dialight Corp., 58 Stewart Ave., Brooklyn 37, N. Y.

Send brochures on Sub-Min. Pilot Lights  
 Brochures on other Dialco Pilot Lights

Name \_\_\_\_\_  
Position \_\_\_\_\_  
Company \_\_\_\_\_  
Address \_\_\_\_\_

CIRCLE 219 READERS SERVICE CARD

# EISLER VERTICAL SPOT WELDERS

MADE IN SIZES 1/2-1-2-3-5 KVA

WITH OR WITHOUT TRANSFORMER OR TIMER

Sent to Any Radio Tube Manufacturer in U.S.A. on a 30 Day Free Trial Basis.

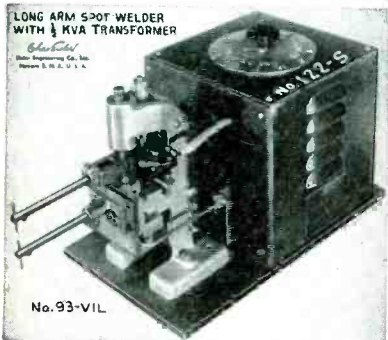
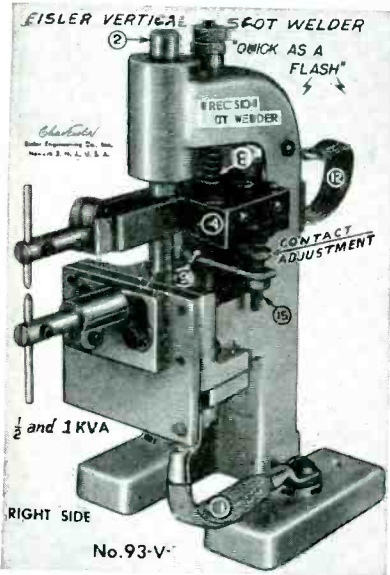

## TRANSISTOR MAKING EQUIPMENT

### DIODE MACHINERY AUTOMATIC OR SEMI-AUTOMATIC

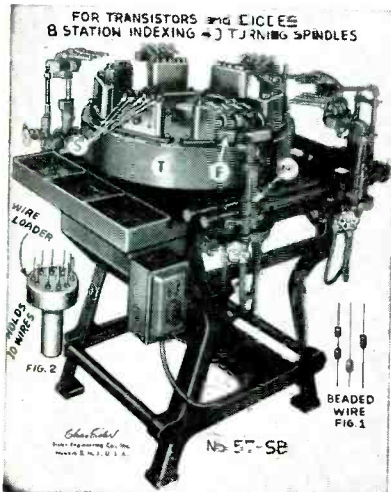

Send for Catalog Dr. Chas. Eisler, M. E. Founder  
CHAS. EISLER, JR., PRES.

**EISLER ENGINEERING CO., INC.**

751 So. 13th St. NEWARK 3, N. J.  
CIRCLE 220 READERS SERVICE CARD

NEW PRODUCTS

(continued)

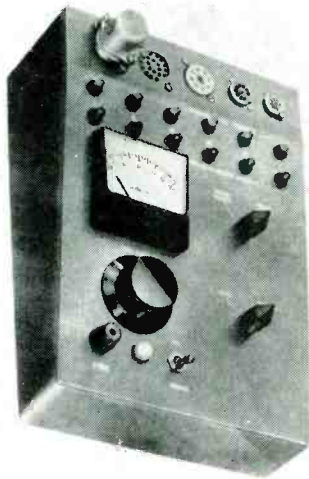

variable from 6 to 150 v. A set of lights indicates opens, shorts, or intermittent contact operation. The tester has five different connector types and adapters are available to permit plug-in of solder-terminal relays. Circle 465 on Reader Service Card.



## TEMPERATURE PROBE

conforms to MIL-P-25726

G. M. GIANNINI & Co., INC., 918 East Green St., Pasadena 1, Calif. Model 49137 total temperature probe conforms to MIL-P-25726. It utilizes a resistive sensing element to accurately measure stagnation temperature over the range of -70 C to 1/2 350 C and at speeds to Mach 1.5.

The pure platinum wire sensing element designed for this instrument is encased in a thin ceramic blanket deposited on a thin-walled cylinder. This ceramic cover effectively seals the element, and protects it from damage by particles entering the chamber. Resistance of the element is 50 ohms at 0 C (temperature coefficient = 0.003 ohm/ohm/deg C from 0 to

# ...IF YOU NEED POWER SUPPLIES

## Call TRANSVAL

Vermont 9-2301, Culver City, California  
For Data on TRANSISTORIZED Power Supplies that gives you these advantages:

- ★ PROTECTED from overload and short-circuit
- ★ DESIGNED to meet YOUR exact specifications
- ★ PRODUCED to meet YOUR schedule

### HIGH VOLTAGE POWER SUPPLY

Output voltage to 1050 volts ( $\pm 5V$ ). Regulation 0.5% with nominal load and input from 109 to 121 volts. Size: 5" x 4" x 4 1/2"; 3 1/2 lbs.

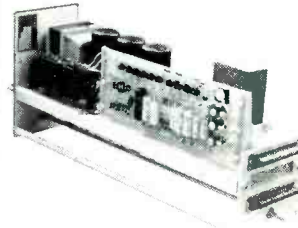

### ULTRA STABLE POWER SUPPLY

Stability of one millivolt over entire output range of 0 to 4 amps at 10 volts. Other voltages with the same stability may also be obtained.

### MULTIPLE HIGH VOLTAGE POWER SUPPLY

Designed for multiple voltage control ranging from -150 volts at 600 ma. to +300 volts at 250 ma. to 6 different voltages per drawer. Can be made to ANY specification.

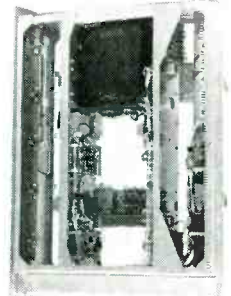

TRANSVAL engineers have set new standards for high stability, light weight power supplies based on advanced techniques of applying transistors. The units shown above are only a few of the many developed by Transval that meet specifications never before considered practical for transistorized power supplies. Among the leading builders of missiles, rockets, and piloted aircraft using Transval transistorized power supplies are Douglas, North American, Northrop, Hughes, Beckman, Norden Ketay, and Canadian Applied Research Ltd.

Find out today how TRANSVAL can help you. Phone, wire, write

## TRANSVAL Engineering Corporation

10401 West Jefferson Boulevard  
Culver City, California

Specialists in Transistorized Power Supplies

CIRCLE 221 READERS SERVICE CARD

December 1, 1957 - ELECTRONICS

100 C), response time is 1.5 sec maximum, and the recovery factor is 0.99 + 0.01.

Specifically developed to meet the requirements of MIL-P-25726, this lightweight temperature probe is ideal for any operational or flight test application requiring accurate and rapid measurement of adiabatic temperatures. Circle 466 on Reader Service Card.



**TIME CODE GENERATOR**  
for airborne use

ELECTRONIC ENGINEERING CO. OF CALIFORNIA, 1601 E. Chestnut Ave., Santa Ana, Calif., is producing an airborne time code generator, employing transistor-driven, magnetic cores. The compact, lightweight unit is designed for missile and aircraft instrumentation.

The 1½ cu-ft unit supplies a 16-bit, 24-hr binary code to hours, minutes and seconds. Signals generated by the equipment are suitable for recording timing marks or time codes on magnetic tape, oscillographs, or to energize neon lights for indicating time code on the edge of motion picture film in optical instrumentation equipment.

The binary code readout is once per sec at a 100 pps rate. Time can be read directly to 0.01 sec and interpolated to 0.001 sec. In addition to binary code, continuous pulse trains of 100 pps, 10 pps, 5 pps and 1 pps are produced. The basic signal source for the airborne time code generator is a



HUMIDITY

**HOPKINS HY-THERM CAPACITORS**  
Can Withstand Highest Humidity



HOPKINS HY-THERM CAPACITORS are hermetically sealed in metal containers with highest quality compression type end seals. They are 100% inspected for leaks and because of the quality construction and use of the finest materials they are without peer in their field. Each HY-THERM capacitor will meet and exceed the applicable military specifications and satisfy the most stringent quality control and reliability programs.

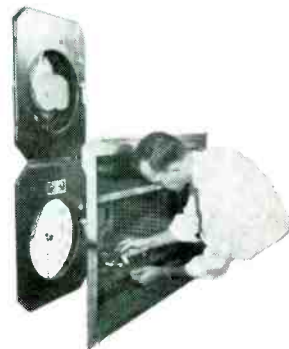

**SEND TODAY FOR DATALOG**

**HOPKINS Engineering COMPANY**

EMpire 1-8691  
12900 FOOTHILL BOULEVARD P. O. BOX 191 SAN FERNANDO, CALIFORNIA  
CIRCLE 222 READERS SERVICE CARD

*Revolutionary, New*

**Epoxy Resin Potted PERMANENTIZED TRANSFORMERS**

*custom built to your specifications*

**GOOD OVERLOAD FACTORS**

**EXTREMELY RUGGED**

**GOOD LOOKING**

**INEXPENSIVE**

**LOW LOSSES**

**HIGHLY RELIABLE**

**LOW TEMPERATURE RISE**

New formula developed by Electro makes possible *reduced size* and more rugged construction in resin-potted transformers. New potting material welds core, coil, case, and terminals, with permanent bonding to case. Built to withstand 170° C. May be qualified under MIL-T-27A, grades 1, 2, 4, or 5 in class R, S, or T, as well as commercial specifications.

**ELECTRO ENGINEERING WORKS, INC.**  
401 Preda St., San Leandro, Calif. • In Metropolitan Oakland area

Make a **GM** PORTABLE D'ARSONVAL

# GALVANOMETER

*the Heart of Your Instrument*

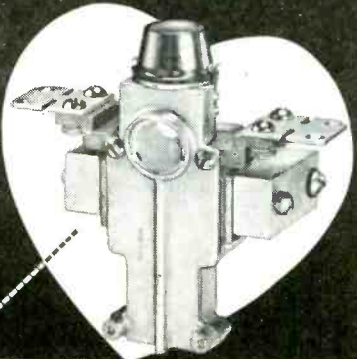
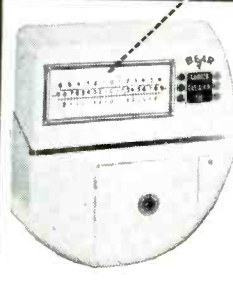
IN THE AUTOMOTIVE FIELD, the Bear Manufacturing Co. of Rock Island, Ill. uses Series 500 G-M Galvanometers in its new remote-reading Electric Wheel Alignment System (left). Whatever your own particular instrument field, you can achieve this same self-contained portability, ruggedness and high sensitivity with G-M Galvanometers. Complete catalog on request.

**GM LABORATORIES • INC.**  
 4336 NORTH KNOX AVE., CHICAGO 41  
 CIRCLE 224 READERS SERVICE CARD

temperature controlled crystal with a long term accuracy of 1 part in 10<sup>9</sup>. Weight of the unit is 20 lb. The unit will operate up to an altitude of 70,000 ft and from temperatures of -40 C to +80 C.

Input power of the unit is 25 w, which is supplied from standard aircraft-type sources. Magnetic cores, silicon transistors and silicon diodes are used throughout the generator; no vacuum tubes are employed.

The generator can also be supplied without the camera neon lamp driver unit which trims its size to 1 cu ft. Circle 467 on Reader Service Card.

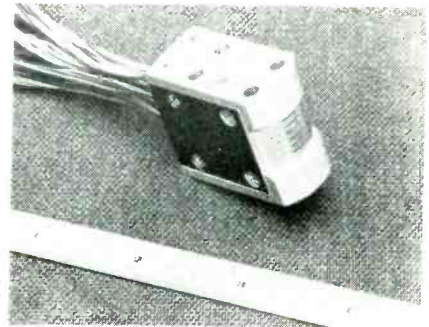

### MAGNETIC HEAD new design for missiles

DATA STORAGE DEVICES Co., 7828 Burnet Ave., Van Nuys, Calif. The 7-channel magnetic tape recording head recently developed can be directly connected to thermocouples to record without the use of amplifiers, using only 20  $\mu$ w. Since the complete system is carried aboard a missile, the head has been designed to withstand high shock and vibration forces as well as high temperature and thermal shock. Other features of this small lightweight, aluminum head, include gap alignment scatter under 1/10 mil, mounting base machined to within 90 deg  $\pm$  15 sec of the gap line and tape guides integral with the head.

The precision features of this head are typical of a complete line of magnetic heads manufactured by the company including drum heads, digital tape heads capable of 2,000 bits per channel per in. with 100 percent resolution, video heads to 4.5 mc, and heads for all types of analog and binaural audio

## UNUSUALLY SMALL "BUTTON SWITCHES" by SWITCHCRAFT<sup>®</sup> INC.

- ✓ 2 Simple Designs—provide many circuits
- ✓ Rugged Metal Housing
- ✓ Completely Enclosed

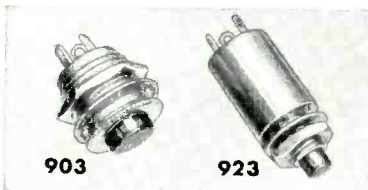

Series 903 (Red Push Button) Series 913 (Black Push Button) for behind panel mounting.  
 Series 923 (Red) Series 933 (Black) mounts from front of panel.  
 Rated at 250 mils, non-inductive load, A.C., 30 watts maximum. See drawing for connections.

Write for catalog S-57A

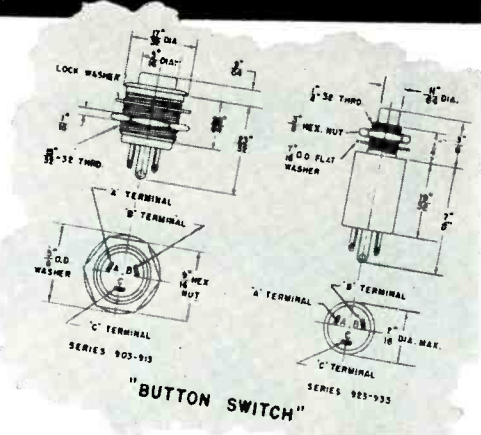

Also Available "TINI-SWITCHES"  
 An open subminiature design.



1336 N. Halsted St.  
 Chicago 22, Ill.

Canadian Rep: Atlas Radio Corp., Ltd., 50 Wingold Ave., Toronto, Canada.

**Tough  
Heyco Nylon  
STRAIN  
RELIEF  
BUSHINGS**

Insulate and anchor the power supply cord to your housing . . .

no need for grommets, wire knots or costly labor.

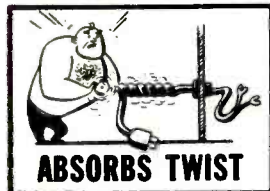
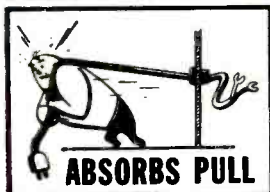

Send for samples to fit your wire, today!

**HEYMAN  
MANUFACTURING COMPANY**  
KENILWORTH 2, NEW JERSEY

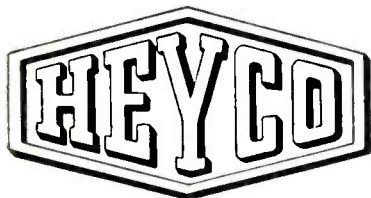

**HEY MAN!  
... SAY HEYMAN**

CIRCLE 226 READERS SERVICE CARD  
ELECTRONICS — December 1, 1957

NEW PRODUCTS

(continued)

recording. Circle 468 on Reader Service Card.

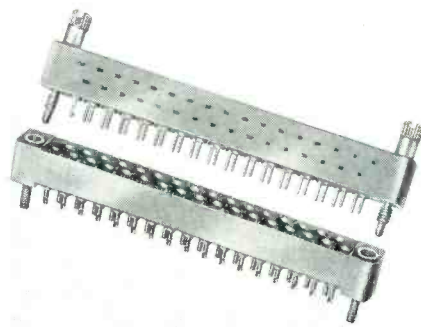

**CONNECTOR**  
for printed circuits

DEJUR-AMSCO CORP., 45-10 Northern Blvd., Long Island City 1, N. Y., has produced a printed circuit connector with patented polarizing screwlocks.

These right angle construction precision connectors are designed for printed board or printed cable applications, and meet airframe requirements for vibration and high altitude. Contact spacing is based on 0.100 grid in accordance with latest EIA printed circuit specifications.

Series 683 connectors are available in 11 or 33 contacts. Standard molding compound is mineral filled Melamine (MIL-P-14E, type MME)—others on request. In addition to the regular solder cup for No. 20 Awg wire, receptacles can also be supplied with taper pin termination for solderless wiring. Circle 469 on Reader Service Card.

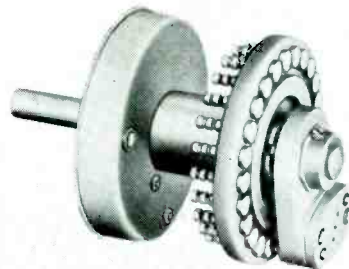

**ROTARY SWITCH**  
with adjustable stop

THE DAVEN Co., Livingston, N. J., has available a new rotary switch with adjustable stop. It is ideal



**THERE IS  
ONLY ONE  
GUDELACE:  
THE  
ORIGINAL  
FLAT  
BRAIDED  
NYLON  
LACING  
TAPE  
MADE BY  
GUDEBROD**

Gudebrod flat braided lacing tapes hold harness securely—no bite-through or slip, yet are easy on the hands. Some resist high temperature, some are color-coded . . . and they come wax-coated or wax-free . . . rubber-coated . . . or with special coating. Gudebrod makes many tapes for many purposes, including defense work. Send us your lacing problems or your specifications . . . we can supply the answer to both.

**GUDELACE • GUDE-NYLACE  
GUDELACE H • TEFLACE**

**GUDEBROD BROS. SILK CO., INC.**

**ELECTRONICS DIVISION**  
225 W. 34th St., New York 1, N. Y.

**EXECUTIVE OFFICES**  
12 South 12th St., Philadelphia 7, Pa.  
CIRCLE 227 READERS SERVICE CARD

## PRECISION DEFLECTION WITH COSSOR YOKES

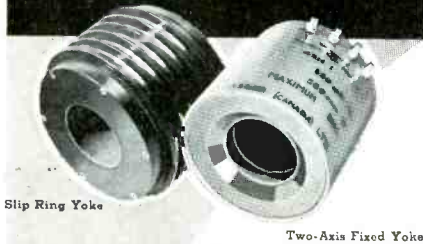

Slip Ring Yoke

Two-Axis Fixed Yoke

### Component Development Engineering at its BEST!

- ADVANCED ELECTRICAL DESIGN
- PRECISION MECHANICAL DESIGN
- ACCURATE PRODUCTION METHODS

Custom Built to the most  
Exacting Specifications  
by Cossor Engineers

In Mumetal Cores for Optimum Geometry  
In Ferrite Cores for Speed and Sensitivity  
In Non-magnetic Cores for Perfection of Response

Any of Cossor's Three Core Types can be made in single or double axis with single or push-pull windings, and encapsulated for fixed or slip ring (rotating) use.

Normal characteristics of yokes for 1-1/2 in. neck tubes are:

**Positional accuracy** - the spot position will conform to the yoke current co-ordinates within 0.25% of tube diameter. For deflection angles less than  $\pm 25^\circ$  better accuracy can easily be achieved.

**Memory** - 0.5% max. without overswing;  
0.1% or less with controlled overswing.

Complete encapsulation in epoxy (stycast) or silicone resins is standard for all Cossor deflection yokes, and is done with special moulding tools ensuring accurate alignment of the yoke axis. When slip rings are added, solid silver rings are mounted in encapsulating resin. The finished slip ring yoke is precision turned to centre bore, and can include bearing mounting surfaces with dimensional tolerances approaching those associated with high quality metal parts.

Settling Time (Micro sec.) =  $120 \sqrt{\text{Inductance in Henries}}$

Sensitivity degrees/milliampere =  $0.095 \sqrt{\frac{\text{Inductance} \cdot \text{millihenries}}{\text{Accelerator Voltage} \cdot \text{KV}}}$

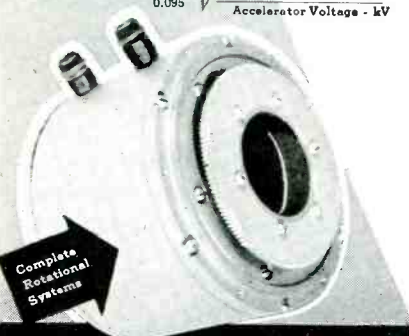

COMPONENTS DIVISION

# COSSOR

CANADA LIMITED

301 Windsor St., Halifax, N. S.  
8230 Mayrand St., Montreal, Que.  
648A Yonge St., Toronto, Ont.  
Corporation House, 160 Laurier West, Ottawa, Ont.

CIRCLE 228 READERS SERVICE CARD

for flexibility in all types of circuit experimentation, laboratory work, breadboard setups, and in circuitry where the exact number of switch positions might be changed at a later date. This unit will have a maximum of either 24 positions with 15 deg spacing or 32 positions with  $11\frac{1}{2}$  deg spacing. One, two, three and four-pole units are available in this design.

Features are: sturdy, dependable construction; large silver alloy contacts and slip rings; temper-proof, knee action silver alloy rotor blades; accurately machined dielectric; and gold flashed turret-type terminals for ease of soldering.

The switches are constructed to meet and exceed applicable military specifications on humidity, moisture, environment, temperature cycling, contact resistance, life, vibration and shock. They will meet and exceed applicable paragraphs of MIL-S-3786, MIL-E-5272, and MIL-T-945A.

Continuous current carrying capacity (not make or break) is 15 amperes. Switches are smooth operating, positive action, rotary selector type. Switch contact resistance remains extremely uniform and is on the order of 0.003 ohm. Capacitance between switch contacts, and between switch contacts and return slip rings, varies from  $0.4 \mu\text{f}$  to  $2.5 \mu\text{f}$  depending on the switch. Breakdown voltage between contacts and slip ring is 3,000 v. Circle 470 on Reader Service Card.



**MAGNETIC FLOWMETER**  
free of obstruction

FISCHER & PORTER Co., 292 Jacksonville Road, Hatboro, Pa., an-



## This Man Has

# E.Q.

# DO YOU?

F. B. Gunter is Manager of Communications Equipment Engineering at Westinghouse-Baltimore. His E.Q. (Exceptional Qualifications) include a B.S.E.E.; four years in the Army and Air Force in ground and airborne radar; 13 years of design and management experience in communications equipment; senior member in I.R.E. and A.I.E.; two patents and a series of papers on carrier and microwave equipment design and application. Today, Frank Gunter and men with similar E.Q.'s are spearheading Westinghouse-Baltimore's advance into the new dimensions of the electronic age.

IF YOU HAVE THE E.Q. to work alongside the men of the Westinghouse-Baltimore team, we suggest that you drop us a letter about yourself. WRITE TO: Dr. J. A. Medwin, Westinghouse Electric Corporation, Dept. 738, P. O. Box 738, Baltimore 3, Maryland.

# Westinghouse



SINCE 1886

## BALTIMORE

Avionics, Air and Underwater Missiles, Advanced Electronics Systems, X-Ray Carrier Microwave, and Induction Heating Equipment for Military, Industrial, and Commercial Purposes.

An Engineer's Company



nounces the development of an obstructionless flowmeter based on magnetic principles. Model 10D1416A is unaffected by extreme operating conditions and can measure with a high degree of accuracy even the most difficult fluids, including slurries or those of a corrosive nature. Pressure drop through the meter body is eliminated since the unit is completely free of any obstruction to flow.

Features of the meter and its specially designed readout equipment are as follows: (1) A manual adjustment to set any flow at full scale. (2) Utilization of full receiver range with maximum flow value as low as that equivalent to 1 ft per sec. (3) Entire system is independent of power line variations over a wide range of voltage and frequency. (4) Fluid conductivity requirements have been minimized. (5) Meter can be substituted directly in existing pneumatic flow control or ratio control systems. (6) Low power consumption. Circle 471 on Reader Service Card.

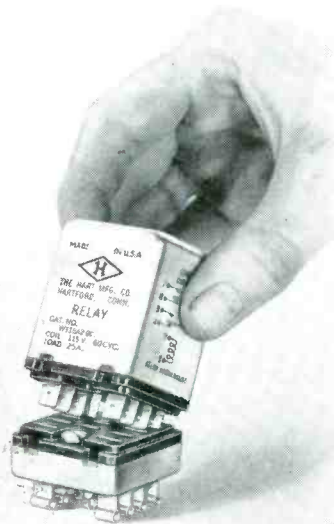

**RELAY SOCKET**  
for close mounting

THE HART MFG. Co., Hartford, Conn., has developed a new socket designed for close mounting of its recently announced Diamond H series W general purpose relays. The socket makes it possible to wire a complete chassis or assem-

**Chip-proof PLASTIC LEGEND PLATES**  
*engrave them yourself*

Tough GRAVOFLEX blanks are laminated in sharp contrast colors. No need to keep large inventory—all sizes, varied colors available on short notice. Low-cost GRAVOFLEX legend plates stand *up* better, stand *out* better!

Use the portable ENGRAVOGRAPH to mark legend plates to your specifications, on the spot, when you need them—with unskilled labor, because it's tracer-guided. Big savings on short runs and "one-shot" jobs. Eliminates costly delays. 17,000 Engravographs in use.

Send for Booklet ZL-1 and sample plate

**new hermes ENGRAVING MACHINE CORP.**  
13-19 UNIVERSITY PLACE, NEW YORK 3, N. Y.  
CIRCLE 229 READERS SERVICE CARD

**NEW GENERAL PURPOSE RELAY**  
(SERIES 130 RELAY)  
THE MOST USEFUL RELAY FOR INDUSTRIAL APPLICATION

- LARGE SILVER CONTACTS self-cleaning
- LARGE BINDING-HEAD SCREWS for No. 12 Wire or Lugs
- MOULDED BAKELITE contact support
- INTERCHANGEABLE COIL
- MULTI-POSITION REMOVABLE MOUNTING BASE

**NO OTHER RELAY IS SO VERSATILE**

**SPECIFICATIONS**

CONTACTS	RATINGS	COILS	MOUNTING BASE
Single-and-double pole	20 amp. at 115 V	AC & DC to 230 V	Metal strap or bakelite. Base can be rotated 90 degrees either direction for mounting convenience.
Single-and-double throw	60 Cy. AC or 24 V DC	(Interchangeable)	
Aux. DT contacts available	U.L. Approved	Power—2 watts	

**DIMENSIONS** Base—1" x 3 7/8"  
Request complete data on Series 130 Relay.

**Wheelock SIGNALS INC.**  
RELAYS LONG BRANCH, N. J.



### COMPLETE FACILITIES FOR PRECISION PRODUCTION OF ELECTRONIC COMPONENTS

Our facilities are geared to meet your production and engineering needs for components of any description. Unusually Complete Tool Room • Press Shop • Hydrogen Annealing, Machining and Polishing Operations • Glass-to-Metal Hermetic Sealing. Production of completed parts ready for assembly in your own plant.

A complete service in our plant means prompt service to your plant.

**Specialists**  
**IN STAMPING AND DRAWING**

• **KOVAR** • **RODAR**  
• **THERLO** • **FERNICO**  
• Other **IRON-NICKEL-COBALT** Alloys

### CUT TOOLING COSTS!

Over 3,000 high precision tools and dies available to reduce your initial tooling time and costs.

Call on us for free consultation and quotations.



**ZELL PRODUCTS CORP.**  
279 Main Street, Norwalk, Conn.

CIRCLE 231 READERS SERVICE CARD

## TELEPHONE AND TELEGRAPH EQUIPMENT

Radio Engineering Products is currently producing a number of types of equipment, electrically and mechanically interchangeable with standard Bell System apparatus.

### CARRIER-TELEPHONE EQUIPMENT

C5 Carrier-Telephone Terminal (J68756). A kit for adding a fourth toll-grade channel to existing C systems is available. • C1 Carrier-Telephone Repeater (J68757) • 121A C Carrier Line Filter • H Carrier Line Filter (X66217C).

### CARRIER-TELEGRAPH EQUIPMENT

40C1 Carrier-Telegraph Channel Terminal (J70047C) • 140A1 Carrier Supply (J70036A1, etc.) • 40AC1 Carrier-Telegraph Terminal.

### VOICE-FREQUENCY EQUIPMENT

V1 Telephone Repeater (J68368F) • Power Supply (J68638A1) • V1 Amplifiers (J68635E2 and J68635A2) • V3 Amplifier (J68649A) • V-F Ringers (J68602, etc.) • Four Wire Terminating Set (J68625G1) • 1C Volume Limiter (J68736C).

### D-C TELEGRAPH EQUIPMENT

16B1 Telegraph Repeater (J70037B) • 10E1 Telegraph Repeater (J70021A) • 128B2 Teletypewriter Subscriber Set (J70027A).

### TEST EQUIPMENT

2A Toll Test Unit (X63699A) • 12B, 13A, 30A (J64030A) and 32A (J64032A) Transmission Measuring Sets • 111A2 Relay Test Panel (J66118E) • 118C2 Telegraph Transmission Measuring Set (J70069K) • 163A2 Test Unit (J70045B) • 163C1 Test Unit (J70045D).

### COMPONENTS AND ACCESSORIES

255A and 209FG Polar Relays • Repeating and Retard Coils, several types • 184, 185, 230A and 230B Jack Mountings.

## RADIO ENGINEERING PRODUCTS

1080 UNIVERSITY ST., MONTREAL 3, CANADA

TELEPHONE  
UNiversity 6-6887

CABLES  
RADENPRO, MONTREAL

bly before plugging in the spade-terminal relays. If necessary, units may be replaced instantly without rewiring. Socket leads may be connected to a panel or terminal board for easy rearrangement of sequencing.

Measuring only  $1\frac{1}{2}$  in. by  $1\frac{1}{2}$  in. by  $1\frac{1}{8}$  in., series W relays are available with standard ratings up to 25 amperes resistive at 115-230 v a-c; 1 hp, 125 v, 2 hp, 250 v a-c, with d-c and other higher ratings obtainable to meet special requirements. Circle 472 on Reader Service Card.



### POWER SUPPLIES use selenium rectifiers

FILM CAPACITORS, INC., 3400 Park Ave., New York 56, N. Y. A line of hermetically-sealed oil-filled power supplies of the full wave voltage doubler type featuring a 5-kv unit has been announced.

Model PS5-S obtains extra long life as a rugged and reliable power supply through the use of selenium rectifiers. This, in conjunction with plastic film h-v capacitors, provides for a compact unit that is small in size and able to meet most military shock and vibration specifications.

The unit delivers 5,000 v d-c at 5.0 ma from a 117 v a-c, 60 cps source. The output voltage may be varied from 0-5,000 v at rated load by varying the input voltage. Ripple is 1.5 percent rms maximum at rated load, less for smaller values of load. This unit can also be used for 400 cps opera-

tion if desired, with no change in output specifications except the ripple, which will be very much reduced.

The base of the unit measures only 3 3/8 in. by 4 1/8 in. and is 6 in. high. Overall height including the solder sealed terminals is 7 1/8 in. Container is CP70 style and utilizes standard CP70 mounting brackets. Circle 473 on Reader Service Card.



**VIDEO AMPLIFIER**  
is rack-mounted

INSTRUMENTS FOR INDUSTRY, INC., 150 Glen Cove Road, Mineola, N. Y., has added a rack-mounted model 395 super-video amplifier to its line of standard amplifiers. It features a very high gain over a wide bandwidth.

Specifications are: bandpass, 1 kc to 50 mc; gain, 70 db; input impedance, 90 ohms; output impedance, 90 ohms; output voltage capability, more than 1 v rms; noise figure, 15 db; gain control, provided on front panel; rise time, 10 millimicroseconds; and tube complement, 24—6AK5's and 1—5R4-GY. Circle 474 on Reader Service Card.

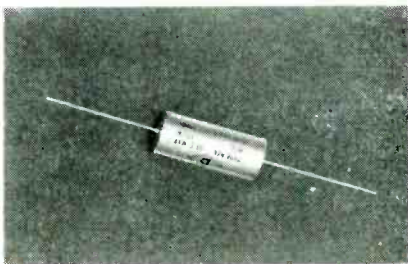

**DIELECTRIC CAPACITOR**  
stable, reliable, rugged

DIAMOND ELECTRONICS CORP., 64 White St., New York 13, N. Y., has

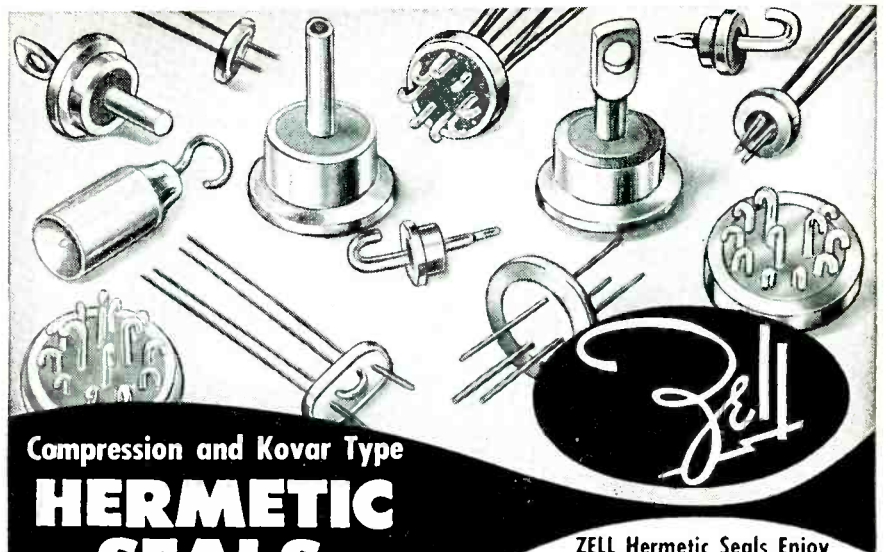

Compression and Kovar Type  
**HERMETIC SEALS**  
"The Seal of Excellence"

ZELL Hermetic Seals Enjoy These Desirable Characteristics:

- ★ A stable finish that protects seals against corrosive atmospheres. ZELL'S GOLD PLATE WITHSTANDS THE MOST STRINGENT TRANSISTOR ETCH TESTS DEvised.
- ★ High resistance to mechanical and thermal shock.
- ★ Excellent electrical properties.
- ★ Tight dimensional tolerances.
- ★ Easy weldability and solderability.

**ALL FACILITIES UNDER ONE ROOF**

- Complete tool room facilities.
- 65 Power Presses (to 50 tons).
- Double stage annealing-fusing furnaces.
- Advanced plating facilities for Nickel, Gold, Tin, Cadmium, Copper, Silver, etc.
- Complete glass facilities.
- Mass Spectrometer leak testing.

ZELL engineers control every process every step of the way, assuring uniform quality and performance.

REPRESENTATIVES: Your Inquiries invited!

**SPECIALISTS IN STAMPING AND DRAWING KOVAR — RODAR — THERLO — FERNICO AND OTHER ALLOYS**  
Sales Engineers: excellent position open, write:

**ZELL PRODUCTS CORP.**  
279 Main Street, Norwalk, Conn.  
The completeness of our facilities assures the completeness of your satisfaction!

CIRCLE 233 READERS SERVICE CARD

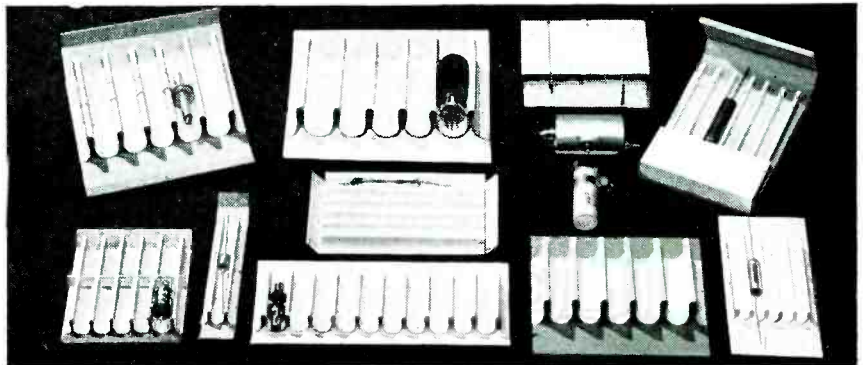

**PROTECT Delicate ELECTRONIC COMPONENTS**  
While Handling in Production and Shipment  
with **RONDO**

RONDO, a cardboard device, holds and protects inserted objects by the spring-clip action of its fluted partitions. Easy to load and handle. Various sizes and styles have been developed for many parts, such as tubes, resistors, capacitors, diodes, fuses, etc., with diameters from 8 to 26mm and up.

Maximum efficiency and economy are accomplished when the same RONDO device is used throughout production, storage, shipping and display. RONDO is a paper product, sold at paper prices.

Send for leaflet and suggestions regarding your specific packing need.

RONDO PROCESS AND DESIGNS ARE COVERED BY PATENTS IN ALL MAJOR COUNTRIES



RECOGNIZED ALL OVER THE WORLD

**AMERICAN RONDO CORP.**, 100A SANFORD ST., HAMDEN 14, CONN.

Representatives: C. S. Shotwell, 527 S. Alexandria Ave., Los Angeles, Cal. • Brown & Scratch, 664 N. Michigan Ave., Chicago, Ill.

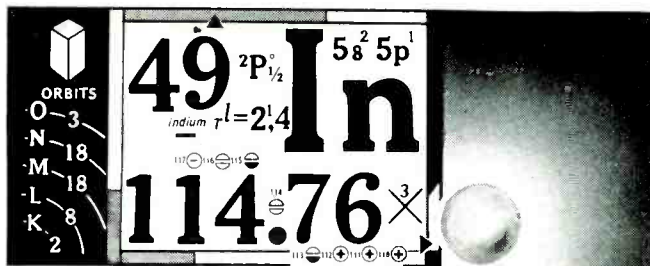

**INDIUM** has properties which you may need

- Resists corrosion
- Aids lubrication
- Unique stabilization

Commercial quantities are available in Indium metal (specially refined 99.999% pure or 99.97% pure), Indium wire, foil, ribbon, pellets, spheres or powders. Also "Indalloy" intermediate solders and other high-purity metals.

Write Dept. E-12 for new Indium bulletin: "INDALLOY Intermediate Solders"

**QUALITY  
SERVICE  
RESEARCH**

**THE INDIUM CORPORATION OF AMERICA**  
1676 Lincoln Avenue • Utica, New York  
Since 1934 . . . Pioneers in the Development  
and Applications of Indium for Industry  
**CIRCLE 235 READERS SERVICE CARD**

## Which Plant Is Yours? A Graphic Wattmeter Will Show You

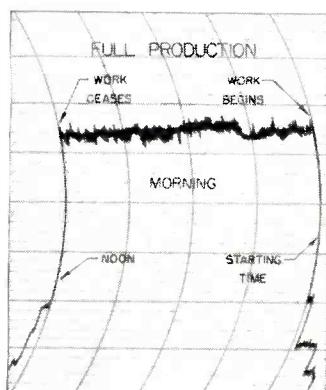
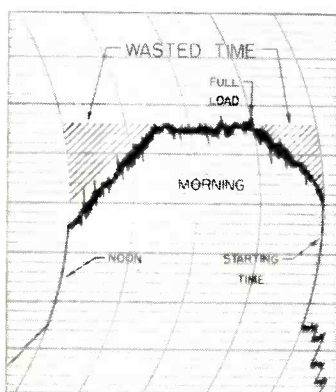

Ask for Bulletin No. 856 — "How to Make Plant Surveys"

Product Representatives in Most Principal Cities

**The ESTERLINE-ANGUS Company, Inc.**

Pioneers in the Manufacture of Graphic Instruments

DEPT. E 8, P. O. BOX 596, INDIANAPOLIS 6, INDIANA

developed a polystyrene dielectric capacitor with excellent stability, reliability and ruggedness. Stability is within  $\pm 0.1$  percent of original value after repeated temperature cycling and under long term load. No capacity drift trend can be detected. New processing and quality control techniques enable 100-percent elimination of border-line components. Short-term life failure is nonexistent and long-term life test results are exceptional.

Lead attachment is accomplished to obtain superior uncased pull strength and uniform contact for minimum noise and power factor. The new method of encasement provides maximum strength to resist severe vibration and shock tests. **Circle 475 on Reader Service Card.**

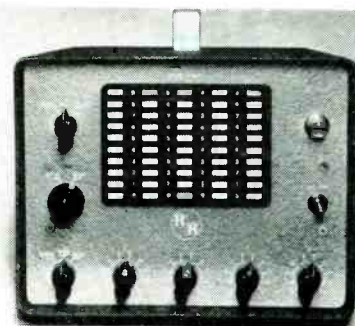

**WAVE TIMER**  
is transistorized

RANSOM RESEARCH, 323 West 7th St., San Pedro, Calif. Model WT-1 wave timer measures electrical signals from one event per sec to 500,000 per sec with five-place accuracy. It may be used as an events-per-unit-time meter. Preset count capacity is up to 9,999 and the precision timer range extends up to one sec in increments of 100  $\mu$ sec.

The wave timer utilizes transistorized plug-in computer elements, thus eliminating all tubes and relays. The instrument consists of a time base, an amplifier, a logic for correctly starting, stopping and recycling the wave timer, a four decade preset counter with no display, and a five decade counter with display.

The instrument is designed to operate with a minimum input

pulse of 5 v or a minimum sine wave signal of 10 v. Input impedance is 10,000 ohms and power requirement is only 20 w. Circle 476 on Reader Service Card.

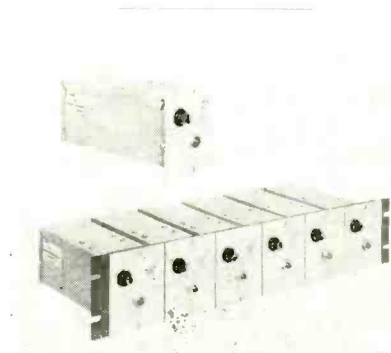

### D-C POWER SUPPLY for use with strain gages

VIDEO INSTRUMENTS Co., INC., 2340 Sawtelle Blvd., Los Angeles 64, Calif. Model SR200 is a transistorized, regulated d-c power supply for use with strain gages.

Output voltage is continuously variable from 5 to 12 v at currents up to 200 ma. Output voltage regulation is  $\pm 0.1$  percent with line input voltage fluctuations from 95 to 135 v. Line voltage transients within this range will not cause overshoot or ringing nor affect rated  $\pm 0.1$ -percent output voltage regulation. The unit may be used on supply voltage frequencies ranging from 50 cps to 400 cps.

The power supply is ruggedly constructed and may be operated in widely varying ambient temperatures. Six units can be mounted in one 19-in. rack panel only  $3\frac{1}{2}$  in. high. Net selling price is \$95 each. Circle 477 on Reader Service Card.

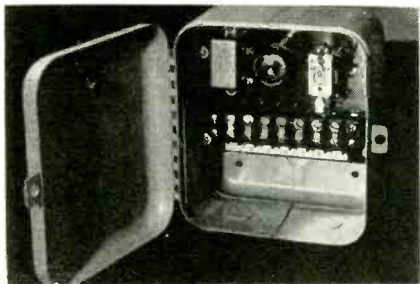

### PILOT RELAY uses cold cathode tube

HALEDY ELECTRONICS Co., 57 William St., New York, N. Y., has an-

# YOKE

**SPECIALISTS**

**COMPLETE LINE for every Military and Special purpose.**

- Yokes for  $7/8"$ ,  $1-1/8"$ ,  $1-1/2"$ ,  $2-1/8"$  neck diameter CR tubes.
- Rotating and fixed coil designs.
- Core material to suit your requirements.

Special test instruments can establish your yoke deflection parameters to an accuracy of  $\pm 0.1\%$ .



Series aiding  
field and parallel  
(bucking)  
field designs.

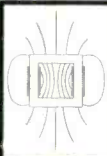

Consult Dr. Henry Marcy on your new applications today.

*syntronic*

**INSTRUMENTS, INC.**

170 Industrial Road • Addison, Ill. • Phone: Terrace 4-6103

CIRCLE 237 READERS SERVICE CARD

## MISSILE TEST DATA TRANSCRIPTION AND ANALYSIS

The transcription, analysis, and evaluation of ballistic missile test data is one of the important aspects of R-W's system engineering and technical direction responsibility for the Air Force Ballistic Missile Program. Utilizing the facilities of R-W's Data Reduction Center, test data are transcribed and reviewed to determine performance characteristics and confidence levels.

The following positions in this rapidly expanding field are currently open on the R-W staff:

Senior analyst to direct mathematicians, engineers, and technical aides in missile test analysis projects and to participate in overall evaluation of missile systems performance. The test information originates from optical, radar, and telemetry instrumentation. Particular emphasis is placed upon electronic analysis of vibration data.

Engineer with wide experience in telemetry operations. The position involves planning and directing the conversion of telemetered data into forms appropriate for the analysis of weapon systems performance. Experience in the design, maintenance, and operation of telemetry data transcription and electronic vibration analysis equipment is desirable.

Engineer experienced in the utilization of missile test data transcription equipment. This position involves the planning of equipment schedules, with various research and industrial organizations, for the conversion of missile test data. A thorough knowledge of the capabilities and limitations of telemetry transcription and electronic vibration analysis equipment is desirable.

*Inquiries should be addressed to: Mr. J. H. Armitage*

**The Ramo-Wooldridge Corporation**

5730 ARBOR VITAE STREET • LOS ANGELES 45, CALIFORNIA

let Williams  
help you apply

**FERRIC  
OXIDES**

to the manufacture  
of your

# FERRITES

You'll be well repaid by getting the facts on a special group of Pure Ferric Oxides, developed by Williams especially for use in the manufacture of ferrites.

Williams Ferric Oxides analyze better than 99%  $Fe_2O_3$ . They contain a minimum of impurities. They are available in a broad range of particle sizes and shapes. Among them, we're certain you'll find one that's "just right" for your requirements. The proper application of Ferric Oxides to the manufacture of Ferrites is our specialty.

Tell us your requirements . . . we'll gladly send samples for test. Chances are good that our Ferric Oxide "Know How" can save you considerable time and money. Address Dept. 25, C. K. Williams & Co., Easton, Pa.

**WILLIAMS**  
COLORS & PIGMENTS

C. K. WILLIAMS & CO.  
Easton, Pa. • East St. Louis, Ill.  
Emeryville, Cal.

**P.S.** We also produce IRN Magnetic Iron powders for the Electronic Core Industry, the Magnetic Tape Recording Industry and others. Write for complete technical information.

CIRCLE 238 READERS SERVICE CARD

NEW PRODUCTS

(continued)

nounced an electronic pilot relay capable of controlling large values of current and power with a current flow of 2 millionths of an ampere through the utilization of a special cold cathode tube of almost unlimited life. This minute flow of current now permits delicate mechanisms with extremely light contact pressures to control large electrical currents.

The cold cathode triode tube (TT-1) is designed for use under the most rugged conditions since it has no heater filament and it is assured almost unlimited life. In effect this results in a minute amount of current required to operate; and in instantaneous starting operation (no warm-up). The relay will operate over any input resistance from a dead short to 10 megohms, with leads of unlimited length. It also boasts a current amplification up to  $2\frac{1}{2}$  million.

Utilizing a 115 v 60 cycle line source the relay consumes 2 w when in operation. The pilot relay is housed in an 18 gage steel case; and a visible jewel indicator permits visibility for off/on operation even while relay case is locked. Price is \$43.87. Circle 478 on Reader Service Card.



## MICROSYNS

have a variety of uses

LEAR, INC., 110 Ionia Ave., NW, Grand Rapids 2, Mich., claims manufacture of the smallest self-contained microsyn available. Approximately 1-in. in diameter and 1-in. long, the units have a sensitivity of 500 mv per deg with a

threshold of 0.01 deg at 20 v excitation. Linearity is within 0.5 percent to 7 deg. The subminiature microsyn weighs less than 1.2 oz.

Intended for use wherever there is need for accurate translation of angular displacement into electrical signals, the miniature units may be used in such applications as position-indication of gyros, control follow-up devices, computation, process control, motion and torque amplification.

The company produces the microsyns with pigtail connectors or with color-coded teflon-insulated terminals. Excitation may be 20 v, 400 cps or 25 v, 800 cps. The units use standard Bu Ord mounting and have demonstrated resistance to the most severe environmental conditions. Circle 479 on Reader Service Card.

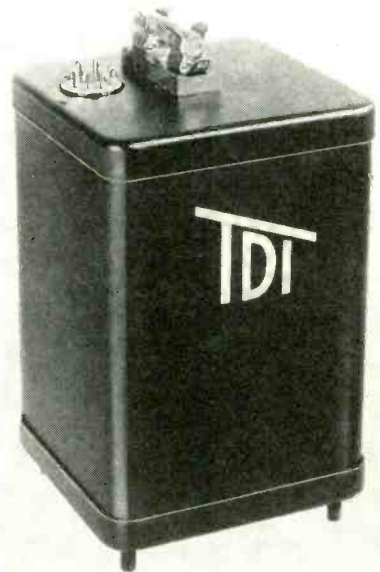

## FILTER

reduces generator ripple

TRANSISTOR DEVICES, INC., 730 Boulevard, Kenilworth, N. J., announces a new filter designed primarily for aircraft, mobile and portable installations to reduce the generator ripple electronically 100 to 1 at worst point, and thereby eliminate the need for heavy chokes.

The unit output (20 v adjustable) is regulated to extremely close tolerance of 0 to 0.5 ampere.

Intended for use with 24 to 28 v d-c systems, the 40 cu in. filter

offers an efficiency of 85 percent and weighs only 2 lb. The electronic filter replaces heavy iron cored filters with a fraction of the weight, and is very easily installed. **Circle 480 on Reader Service Card.**



### BASIC SWITCH

features ceramic case

ELECTRO SNAP SWITCH & MFG. CO., 4218 West Lake St., Chicago 24, Ill. The new basic switch S9-4 provides precision tolerances in an ambient temperature range of  $-100$  deg to  $+900$  deg F. The ceramic case contains the company's standard switch mechanism for spdt two circuit electrical control with a probable mechanical life of 750,000 cycles of operation. The staggered screw terminals, made of stainless steel, permit easy wiring. The switch case measures  $1\frac{1}{4}$  in. long with standard 0.101 diameter mounting holes.

The switch is rated: 5 amperes 125/250 v a-c, 30 v d-c inductive. **Circle 481 on Reader Service Card.**



### ELECTRICAL CONNECTORS are miniaturized

AMPHENOL ELECTRONICS CORP., Chicago 50, Ill. A complete line of miniature electrical connectors has been announced. Named "minni E", the connectors are described as being the first miniatures fully conforming to the "E"

performance requirements of MIL-C-5015C. Besides being offered in an "E" construction, these connectors are available in potting, cable clamp and jacketed cable types—the potting construction also meets the moisture resistant requirements of MIL-C-5015C. Temperature limits are  $-67$  F to  $+257$  F. Voltage ratings are 500 v rms at sea level and 600 v rms at sea level. Using mated sealed connectors, no derating for altitude is necessary at 70,000 ft.

Features include a spring-loaded coupling ring, stainless steel bayonet slots and pins, hooded female contacts, unitized rear grommet seal, face seal gaskets and visual full engagement indicator. "Minni E's" are offered in 5 shell sizes and 17 insert arrangements, including coax contacts. Hermetically sealed receptacles are also available.

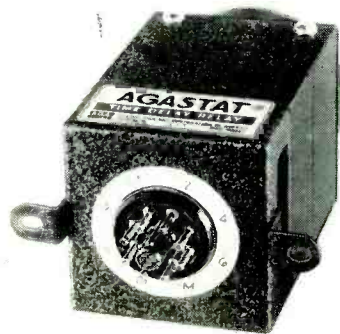

### TIME DELAY RELAY has octal plug adapter

AGA DIVISION, Elastic Stop Nut Corp. of America, Elizabeth, N. J., has developed a new plug-in feature for its basic Agastat time delay relay models. The new octal plug feature adapts the Agastats to products and machines using plug-in components.

The octal plug is wired internally to the Agastat to allow immediate installation and operation. Two timing adjustments are available, a needle valve and a dial head adjustment. Each is adjustable from 0.1 sec to 15 minutes. There are four timing ranges available in the dial head type,

## another BURROUGHS digital instrument...

*brings the precision of digital comparison, measurement, and counting to the test laboratory. One of a series of special purpose instruments designed for the digital specialist.*

### high frequency PULSE GENERATOR

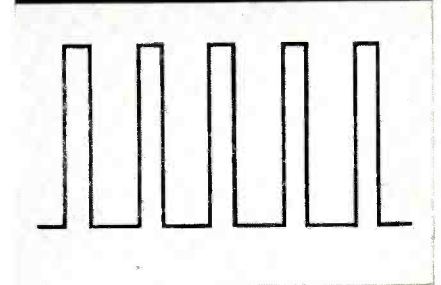
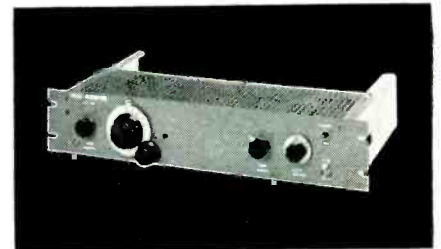

The Burroughs Type 1050 Generator produces half sine wave pulses in the 10 mc range. Pulse width may be 30, 40, 50, 60, or 70 millimicroseconds. Pulse amplitude is adjustable from 1 to 30 volts of either polarity.

Further information is available from Dept. C.

tools for engineers



BURROUGHS CORPORATION  
Electronic Instruments Division

1209 Vine Street Philadelphia 7, Pa.  
CIRCLE 239 READERS SERVICE CARD

Designed for



Application



90672

### The No. 90672 ANTENNA BRIDGE

The Millen 90672 Antenna Bridge is an accurate and sensitive bridge for measuring impedances in the range of 5 to 500 ohms at radio frequencies up to 200 mc. It is entirely different in basic design from previous devices offered for this type service inasmuch as it employs no variable resistors of any sort. The variable element is an especially designed differential variable capacitor capable of high accuracy and permanency of calibration over a wide range of frequencies. A grid dip meter such as the Millen 90651 may be used as the source of RF signal. The bridge may be used to measure antenna radiation resistance, antenna resonance, transmission line impedance, standing wave ratio, receiver input impedance and many other radio frequency impedances. By means of the antenna bridge, an antenna matching unit may be adjusted so as to provide the minimum standing wave ratio on the radiation system at all frequencies.

**JAMES MILLEN  
MFG. CO., INC.**

MAIN OFFICE AND FACTORY  
**MALDEN  
MASSACHUSETTS**



and each timing range is color coded for quick identification. Adjustments may be made within these timing ranges.

These time delay relays are relatively unaffected by wide temperature changes from  $-65$  to  $+160$  F. They can be supplied for continuous a-c duty and for continuous or intermittent d-c service. They are available for a-c operation at all standard voltages from 6 to 550 v, 60 cycles and 25 cycles. For d-c operation, they are made for all standard voltages from 6 to 230 v. Circle 482 on Reader Service Card.

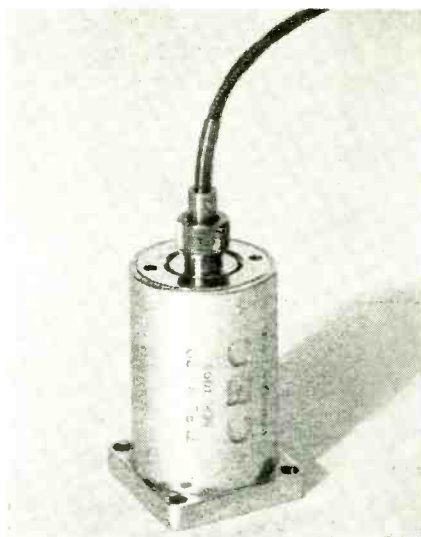

### VIBRATION PICKUP has outstanding linearity

CONSOLIDATED ELECTRODYNAMICS CORP., 300 North Sierra Madre Villa, Pasadena, Calif. A new vibration pickup, designed to be the critical standards of laboratory accuracy yet filling all the requirements of operational use, is now available. Type 4-120 was developed for ground and in-flight monitoring of jet engines, but can be used in all h-f, low-amplitude vibration studies under extremes of temperature. The instrument is capable of continuous operation from  $-65$  F to  $+500$  F. It has a frequency range of 40 to 2,000 cps with linearity of  $\pm 4$  percent of reading (for constant frequency) over the entire range.

Insensitive to transverse vibration, it will produce a signal directly proportional to the velocity

as low as the recording equipment will measure. Maximum acceleration without damage is 50 g.

Among other important design features is the use of two magnets, one to control sensitivity and the other to control damping. This makes it possible to adjust the critical damping for specific temperatures up to 400 F. Another feature is a hermetically sealed case. The new unit is  $1\frac{1}{4}$  by  $2\frac{3}{4}$  in. and weighs less than 5 oz. Circle 483 on Reader Service Card.

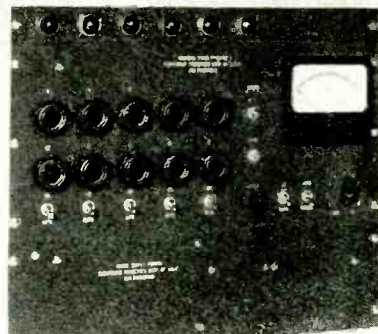

### PROGRAM TIMER with plug-in major parts

ELECTRONIC PROCESSES CORP. OF CALIFORNIA, 2190 Folsom St., San Francisco 10, Calif., announces a new electronic program timer which will independently control the sequence and timing of several related operations of a machine or process. Model PT-157 is designed to permit rapid and accurate change of the time settings controlling each operation and eliminates complicated and time-consuming cam adjustments.

The unit as shown controls both the on-and-off sequence of six different operations. More operations may be controlled by adding one switching comparator for each additional on-and-off operation. Complete versatility as well as ease of maintenance is provided through the unitized plug-in construction of the major component parts.

Time cycles up to 5 minutes are available, with accurate settings for each time control made against a calibrated meter. The time setting for any operation may be varied as the cycle is in progress without interrupting the time



cycle or the settings of the other operations. Remote start and emergency stop switches are available, and circuit wiring flexibility is provided by a wiring duct. **Circle 484 on Reader Service Card.**



### INDICATOR

anticipates bearing failures

LYCOMING DIVISION, Avco Mfg. Corp., Stratford, Conn. A unique precision instrument capable of anticipating bearing failures in rotating machinery has been announced.

The temperature acceleration indicator acts as an electronic "detective" by detecting acceleration of temperature rise in a variety of units. It has applications for aviation, industrial and automotive development fields. **Circle 485 on Reader Service Card.**

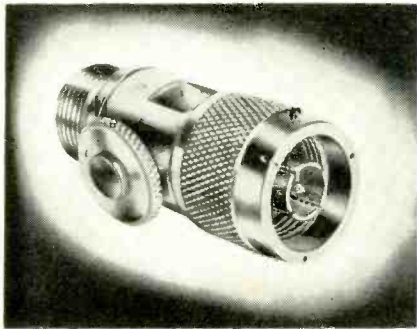

### TUNING STUB

for use in uhf and shf

DON-LAN ELECTRONICS, INC., 1101 Olympic Blvd., Santa Monica, Calif. An inexpensive subminiature broadband coaxial matching and tuning stub for use in uhf and shf (to 10,500 mc) consists of a compact element furnished with a

simple knob which is turned until the desired match is reached, then locked into position.

The unit, called a Widjet, is a 1.6 oz stub which takes the place of bulky telescoping matching stubs or tuning elements now in use. It consists of a variable temperature-compensated capacitor which is incorporated in the connector.

By simplifying problems of tuning, the Widjet allows the use of much less expensive components in coaxial systems. Less precise units which would otherwise produce vswr can easily be tuned out.

The unit is designed for applications in antenna systems of relays, communications, iff, radar and other r-f areas. Male and female type N connectors of the stub allow simple installation in existing systems. The unit meets or exceeds environmental requirements of MIL-E-5272A. **Circle 486 on Reader Service Card.**

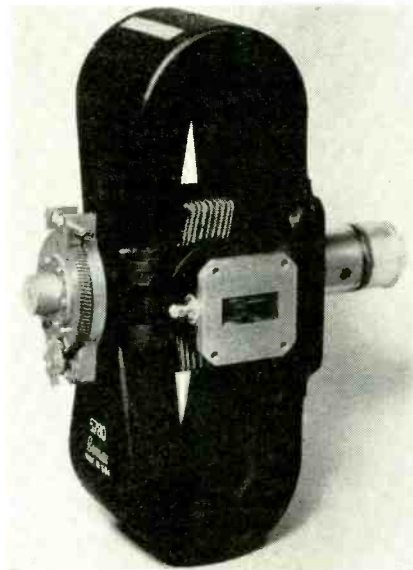

### X-BAND MAGNETRON

tunable over 8,500-9,600 mc

BOMAC LABORATORIES, INC., Salem Road, Beverly, Mass., has added the 5780 tunable X-band magnetron to its expanding line of microwave oscillator tubes. The 5780 is an integral magnet, air-cooled, pulsed type magnetron, which is continuously tunable over a frequency range of 8,500 to 9,600 mc. Being capable of reliable performance at over 300 kw (peak)

## another BURROUGHS digital instrument...

*brings the precision of digital comparison, measurement, and counting to the test laboratory. One of a series of special purpose instruments designed for the digital specialist.*

### DELAY GENERATOR

produces Accurate variable time pulses

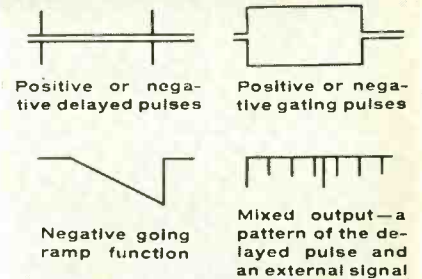
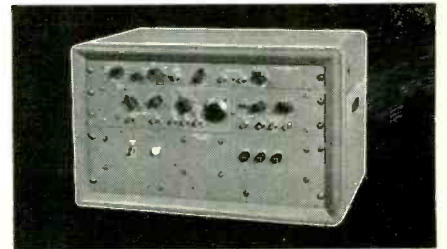

The Burroughs Delay Generator Type 6010 produces the four types of pulse outputs shown above. Delays can range from 1 to 10,000  $\mu$ sec. Instrument accuracy is 1%, and jitter is better than 0.02%.

Further information is available from Dept. C.

tools for engineers



BURROUGHS CORPORATION  
Electronic Instruments Division

1209 Vine Street Philadelphia 7, Pa.  
CIRCLE 241 READERS SERVICE CARD

# NEW

from the Grayhill Sketch Book

## ULTRA-MINIATURE

### Series 39-1

#### PUSH BUTTON SWITCH



ACTUAL SIZE

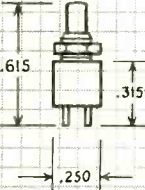

- Single pole, single throw, momentary contact, normally open.
- Conservatively rated 1/10 ampere at 115 volts AC, Resistive.
- Life expectancy approximately 1,000,000 operations.
- Maximum panel thickness 1/16" —requires 3/16" dia. hole.

Makes possible heretofore impractical applications of push button switches.

Write for complete details

Telephone  
Fleetwood  
4-1040



523 Hillgrove Avenue, La Grange, Illinois

CIRCLE 242 READERS SERVICE CARD

NEW PRODUCTS

(continued)

power output, the 5780 is extremely well adapted for use in short pulse, X-band applications where high power output is desired.

The cathode terminal and mounting plate of the tube are designed to fit the standard fixed-frequency 4J50 mounting socket. The 5780 is 10 in. (maximum) long, 8.250 in. (maximum) wide, and weighs approximately 15½ lb. Circle 487 on Reader Service Card.



#### TRUE RMS VOLTMETER

rugged and compact

CONSOLIDATED ELECTRODYNAMICS CORP., 300 N. Sierra Madre Villa, Pasadena, Calif., has available a stable, highly sensitive electronic voltmeter, designed for measuring a-c voltage in systems where it is imperative to know the true rms magnitude of nonsinusoidal periodic waveforms or noise potentials.

Model 14A features extreme accuracy in combination with rugged, compact construction. Low-current-consuming transistors, space-saving printed wiring, and dependable miniature components have been used to provide a reliable, small (6 by 8 by 6 in.), and lightweight (7½ lb) instrument. It operates on 115-v, 60 cps a-c.

The voltmeter is particularly suitable for use in noise-figure determination and in making noise-level measurements of equipment operating at audio and carrier frequencies. It utilizes a thermomilliammeter, a transistor amplifier, and a coaxial input attenuator to provide full-scale indication for input voltages from 0.5 mv to 200 v. Accurate readings from 15 cps to 500 kc are provided. Voltage differences as small as 0.5

## FEATURE YOUR PRODUCT in a distinctive BALTIC CUSTOM-BUILT CABINET

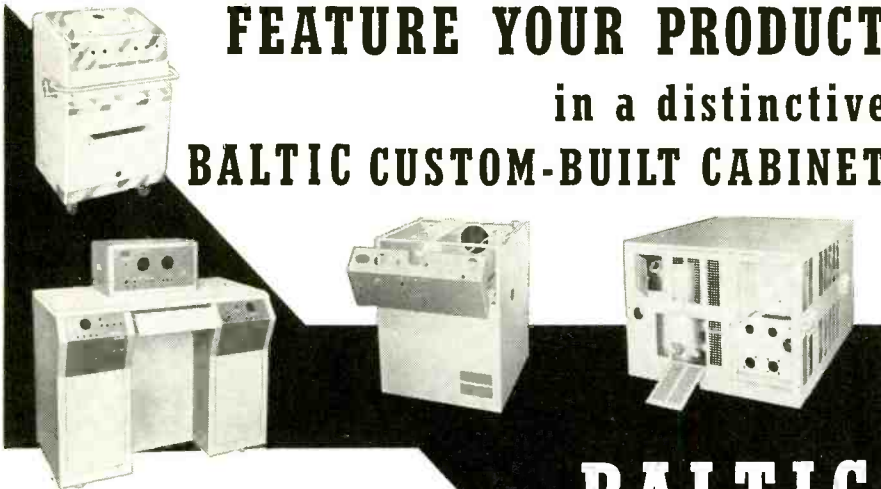

# BALTIC BUILDS IT BETTER!

...and it needn't be expensive because Baltic is especially equipped and set up with 25 years' experience in the economical production of sheet metal fabrication. Complete facilities for assembling and finishing both long and short runs, in all metals up to ¼", in our block-long modern plant. All welding Government certified.

Send us your rough sketches, blueprints or specifications for prompt quotations.

### BALTIC METAL PRODUCTS CO.

126 SUTTON ST. BROOKLYN 22, N. Y. • EVergreen 4-2300



percent can be detected on the large meter. Further information appears in CEC Bulletin 7003. **Circle 488 on Reader Service Card.**

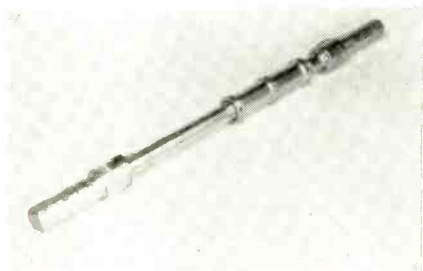

**TIME DELAY LINES**  
tubular, semiadjustable

DELTIME, INC., 608 Fayette Ave., Mamaroneck, N. Y., has announced model 107 semiadjustable tubular delay lines. The delay length may be specified by user and is adjustable over a range of 5  $\mu$ sec. Adjustment is made by turning a sleeve along the threaded body. Intermediate pickoff may be specified as required. Body diameter is 1  $\frac{1}{8}$  in. maximum, while length of tubular casing is dependent upon the delay factor. Construction is suitable for resisting the most strenuous environmental conditions. Literature is available. **Circle 489 on Reader Service Card.**



**POWER SUPPLY**  
for transistor work

MODEL RECTIFIER CORP., 1065 Utica Ave., Brooklyn 3, N. Y. The new DV60-2 transistor power supply

features ripple attenuation down to a maximum of 0.05 percent at full rated output. This compact and precision-made unit, designed for developmental and experimental transistor work, delivers 0 to 60 v d-c, at currents up to 1,000 ma. Conservatively rated, it employs no moving parts and features isolated output.

The manufacturer states that one DV60-2 transistor power supply will replace several high-cost power sources, and end annoying battery hook-up problems. The a-c line operated unit employs a continuously variable autotransformer; a full-wave bridge selenium rectifier and a 2-section choke input filter in its simple, trouble-free circuitry. Located up front and easily accessible are a protective magnetic circuit breaker; a 2-position voltmeter range switch; a 3-position milliammeter range switch; modern, easy-to-read volt and milliammeters accurate to 2 percent; and 5-way output binding posts.

Measurements are 10  $\frac{3}{8}$  in. by 7 in. by 9  $\frac{1}{4}$  in. **Circle 490 on Reader Service Card.**

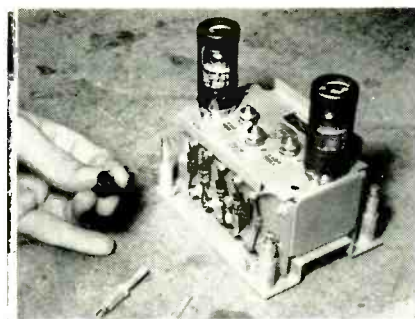

**CAPTIVE FASTENER**  
for use on subassemblies

MORAN Co., 115 Main St., El Segundo, Calif. A new type of captive fastener particularly adapted for use on electronic subassemblies, has been licensed for manufacture and marketing to the Moran Co., by Northrop Aircraft, Inc., developers of the device.

The fastener consists of a swaged-in-place sleeve, a bolt with both a threaded shoulder and shaft, and a small spring. Two threads at the top of the swaged-in-place sleeve accommodate the threaded shoulder of the bolt. Two turns of

another  
**BURROUGHS**  
digital  
instrument...

*brings the precision of digital comparison, measurement, and counting to the test laboratory. One of a series of special purpose instruments designed for the digital specialist.*

**PULSE CALIBRATOR**  
measures peak amplitude

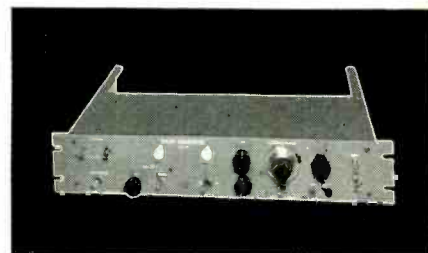

Measuring current amplitude

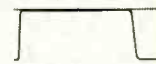

Measuring voltage amplitude



Measuring pulse width or rise time

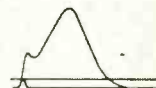

Burroughs Type 1810 pulse calibrator permits accurate oscilloscope measurements of voltage amplitude, current amplitude, pulse width or rise time. Over-all instrument accuracy of 1% extends from the millivolt range to 50 volts. Input may be ac, dc, or pulse.

Further information is available from Dept. C.

tools for engineers



**BURROUGHS CORPORATION**  
Electronic Instruments Division

1209 Vine Street Philadelphia 7, Pa.  
**CIRCLE 244 READERS SERVICE CARD**

# SILVER PAINT AND SILVER PASTE

Take the "bugs" out of the application of conductive silver coatings. Use Drakenfeld silver paint and silver paste tailored to meet your needs. We formulate special compositions for glass and ceramic bodies and other materials. Let us know your specific requirements. Samples will be supplied to fit them. Your inquiry will receive prompt attention.

**B. F. DRAKENFELD & CO., INC.**

Box 519, Washington, Pennsylvania

*Drakenfeld*

YOUR PARTNER IN SOLVING CONDUCTIVE COATING PROBLEMS

CIRCLE 245 READERS SERVICE CARD

*one reliable source for all your*

## CLIP, BLOCK and HARNESS STRAP needs!

ADEL offers the widest variety of LINE SUPPORTS in the World . . . 19,000 different types and sizes for safe, vibration-free, positive support in all types of aircraft, missiles, rockets, ordnance, automotive and original equipment of all kinds.

SAFETY . . . FLEXIBILITY . . . DURABILITY . . .  
ECONOMY . . . SERVICE FITTED . . . SERVICE  
TESTED . . . SERVICE APPROVED

Illustrated are but a few of the World's most complete line of Line Supports that meet or exceed all applicable specifications and/or requirements. Whatever the application—STANDARDIZE ON ADEL—the leader in completeness of line, service and reliability.

*Reliability*

**ADEL** PRECISION  
PRODUCTS  
A DIVISION OF GENERAL METALS CORPORATION

SPECIFICATIONS ARE AVAILABLE TO AIRCRAFT, MISSILE AND ORIGINAL EQUIPMENT MANUFACTURERS . . . WHAT ARE YOUR REQUIREMENTS?

Direct inquiries to Huntington Division  
1444 Washington Ave., Huntington 4, W. Virginia  
DISTRICT OFFICES: Burbank • Mineola  
Dayton • Wichita • Dallas • Toronto



the bolt carry it through the threads to become captive within the sleeve, held in place by a small tension spring.

The subassembly may then be tightly fastened to a major assembly by turning the bolt into tapped holes or other mating fasteners until the bolt tightens on a shoulder in the lower part of the sleeve.

Advantages of the new device include elimination of loose fastener parts on the assembly or repair bench and its quick detach features. The bolt has a hexagonal, slotted head permitting use of either screw driver or wrench to attach or detach the subassembly. **Circle 491 on Reader Service Card.**

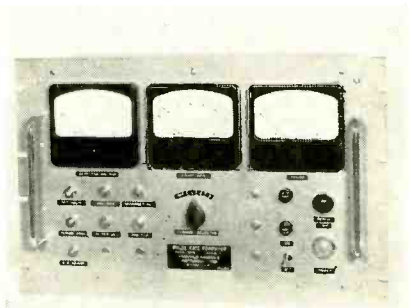

## PULSE RATE COMPUTER in new instrumentation line

FAIRCHILD CAMERA AND INSTRUMENT CORP., Robbins Lane, Syosset, L. I., N. Y. Transistorized nuclear reactor control instrumentation can now be obtained for immediate delivery. This instrumentation covers the start-up, intermediate, and power ranges of operation. Various optional combinations and modifications are available, providing custom-flexibility to meet all requirements.

This equipment comes in either: (a) commercial specification for use in laboratories and commercial power plants, or (b) military specification for use aboard Naval vessels and in Army packaged power plants.

The present design using silicon transistors only, is for operation up to 65 C and 100 percent humidity conditions. Equipment for higher temperatures can be supplied. Complete technical manuals and evaluation reports are available on request. **Circle 492 on Reader Service Card.**

## New Literature

**High Reliability Capacitors.** The Gudeman Co., 340 W. Huron St., Chicago 10, Ill., has released a catalog, XR-461, on their line of high reliability capacitors. The capacitors discussed are manufactured under strict quality control procedures governing raw material selection and manufacturing conditions. **Circle 501 on Reader Service Card.**

**Switch Catalog.** Centralab, a Division of Globe-Union Inc., 900 E. Keefe Ave., Milwaukee, Wis. A new 35-page manufacturer's switch catalog with complete specifications on rotary, slide, and lever switches is available.

The new catalog provides specifications on the complete line of Centralab switches capable of handling power from 1 kw to 1  $\mu$ w. **Circle 502 on Reader Service Card.**

**Production Machine.** Burg Tool Mfg. Co., Inc., 15001 South Figueroa St., Gardena, Calif., has available literature on the Burgmaster six- and eight-spindle automatic, hydraulic turret drills which feature preselective spindle speeds, preselective feeds and precision depth control. The machines described have many uses in production of electronic assemblies. **Circle 503 on Reader Service Card.**

**Transistor Analyzer.** Norden-Ketay Corp., Commerce Road, Stamford, Conn., The four-page bulletin No. 387C describes the BCT-300 transistor curve tracer. Data include a block diagram showing the variety and flexibility of test functions, as well as specifications and photograph showing functionally located operating controls. **Circle 504 on Reader Service Card.**

**Servomechanical Parts.** Reeves Instrument Corp., 207 E. 91st St., New York, N. Y., has available a new 32-page comprehensive catalog of servomechanical parts. It describes a complete line of miniature and standard parts for prototype and production servos.

Included are descriptions and specifications for precision gears, mounting plates, shaft hangers,

# TELREX LABORATORIES

Designers and Manufacturers of

## COMMERCIAL SERVICE "BEAMED-POWER" ARRAYS

Calibrated  
for the commercial  
13 to 14  
mc. band.  
Other  
frequencies  
available.

Model Illustrated  
No. CX-13-14

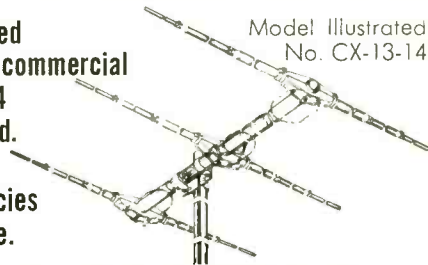

Precision Tuned, Matched and Calibrated for easy assembly and repetition of our Specifications at your site, providing optimum gain per element and hi-signal-to-noise, hi-signal-to-interference "Balanced Pattern."

Electrical Specifications: Gain 8 db, F/B ratio 28 db, V/S/W/R 1.2/1 or better! Impedance, 52 ohm thru coaxial halfwave "Balun" (supplied). Power capacity 5 KW - Higher power models available at extra cost.

Mechanical Specifications: Wt. 60 lbs., 3" OD x 26 ft. boom, taper swaged elements, tapering from 1 3/8" OD to 1/2" OD, incorporating stainless steel hardware, "Borg-Warner" Cyclocac moldings, 1/4-20 S.S. junction terminals and heavily cadmium plated mounting plate. Wind surface area: 7 sq. ft. Wind load at 100 mph: 210 lbs.

Price \$338.00 f.o.b. Asbury Park, New Jersey  
Available three (3) days after receipt of order.  
Descriptive literature on request.



ASBURY PARK 25  
NEW JERSEY, U.S.A.

Tel. PRospect 5-7252

CIRCLE 247 READERS SERVICE CARD

new from trio...

## build-in miniature phase-sensitive AC VTVMs

for building into military & industrial test & operating equipment. Both single- and multi-range zero-center models indicate  $V \cos \theta$  - the product of signal magnitude & cosine of phase angle between signal & reference voltages. No controls or operating adjustments. When signal & reference are in phase, meter deflects to right; when out of phase, to left. Ideal for AC null readings. Perfect quadrature rejector as long as signal magnitude does not exceed full scale. Wide variety of standard packages. Sensitivities of single-range models from 10 MV; multi-range, as low as 1 MV.

For free 36-page Engineering Guide, write to Dept. E-12  
Trio Laboratories., Seaford, N. Y.



when ordinary instruments are  
too big or inadequate...

**trio**

Little Mag says . . .

"DID YOU KNOW THAT  
**MAGNATRON** IS HELPING  
'BUILD A FENCE  
AROUND YOUR BACKYARD?'"



### The Distant Early Warning (DEW)

radar picket line is that safety fence.

Its performance must be absolutely dependable.

Magnatran heavy duty components including unitized rectifiers, are the "standard" power supplies in the vital transmitters completing the system.

Whenever you require reliability and dependability you too can use.

Magnatran transformers.



**MAGNATRON** incorporated

P.O. Box 211 KEARNY, NEW JERSEY, U.S.A.

See page 39  
'56 Electronic Buyers Guide

CIRCLE 249 READERS SERVICE CARD

### TYPE 803

## Antenna Coupling or Matching Transformer

Compact • Watertight Housing

The NEMS-CLARKE Type 803 Antenna Coupling or Matching Transformer is designed to match a 700 or 200 ohm receiving antenna or balanced transmission line to a 72 or 52 ohm coaxial line with a minimum transmission loss over the range of 1 to 50 megacycles. The insertion loss is less than 1 db at midband. A spark gap arrangement has been provided for protection against the effects of lightning. The transformer and circuitry has been arranged to provide DC continuity through the antennas for checking purposes. The plug in transformer has an octal base to allow easy replacement. Printed circuitry is used to insure uniformly high performance.

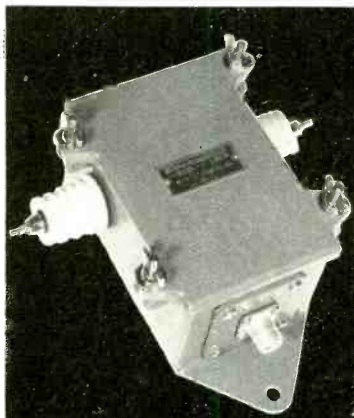

CLOSED VIEW

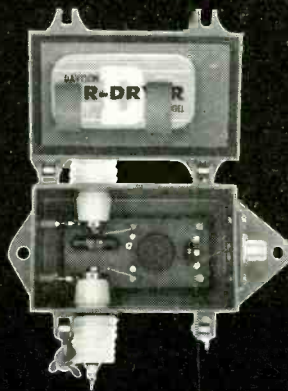

OPEN VIEW

## NEMS • CLARKE



A DIVISION OF VITRO CORPORATION OF AMERICA

919 JESUP-BLAIR DRIVE  
Silver Spring, Maryland

For further information write department AC-1

CIRCLE 250 READERS SERVICE CARD

NEW LITERATURE

(continued)

dial assemblies, couplings, and many other parts for assembling servo systems. Circle 505 on Reader Service Card.

**Cradle Folder.** Augat Bros. Inc., 33 Perry Ave., Attleboro, Mass. A 16-page booklet illustrates and gives dimensional diagrams and technical specifications for a wide line of cradles that feature heat transfer, and cushion from shock and vibration. It describes cradles for subminiature tubes, resistors, capacitors, transistors, diodes, capacitors, crystals and relays. Circle 506 on Reader Service Card.

**Condensed Connector Catalog.** U.S. Components, Inc., 456 East 148th St., New York 55, N. Y., has available a condensed version of its comprehensive catalog of power and electronic circuit connectors, and associated equipment. The short-form catalog illustrates the company's complete line of connectors, and lists key specifications and operating characteristics. The line covered includes subminiature and miniature power and electronic connectors in several configurations; pressurized, waterproof and hermetically-sealed. Also shown are printed circuit connectors and card receptacles. Circle 507 on Reader Service Card.

**Microwave Components.** Microwave Associates, Inc., Burlington, Mass. A 16-page illustrated booklet covers the company's work in the field of waveguide components, magnetrons, semiconductors, and switching devices. Skills and facilities, production and administrative functions are outlined. Also included are pictures of the staff with their individual backgrounds. Circle 508 on Reader Service Card.

**A-F Amplifiers.** Cinema Engineering Division of Aerovox, 1100 Chestnut St., Burbank, Calif., has issued a catalog on its audio-frequency amplifiers, a dozen pages with illustrations, charts and diagrams.

The Cinema amplifier line stresses the laboratory type units and was designed essentially for maintenance-free sound systems,

scientific laboratories, tape and disk recording equipment, motion picture film recording use and other purposes.

Each model and style described is adapted for individual applications, as well as for large multiple installations. Technically, the items discussed use custom-built transformers, precision wire-wound resistors, and other high quality components to provide constant performance and reliability.

Neither input nor output transformers are included in feedback loops; thus providing complete isolation. A new standardized plug-in chassis assembly further increases flexibility of application. Specifications listed in catalog 16-C are based on normal v-t characteristics. **Circle 509 on Reader Service Card.**

**Preset Electronic Counters.** Post Machinery Co., Beverly, Mass. A single-sheet bulletin covers the model PW-5 preset counter designed for accurate reliable industrial preset counting up to 5,000 units per second with direct readout totalizer. Description, features, optional features and specifications are included. **Circle 510 on Reader Service Card.**

**Transistorized Amplifiers.** Universal Transistor Products Corp., 143 E. 49th St., New York 17, N. Y. A timely new four-page case history brochure shows how the company solves difficult amplifier problems for diversified segments of the electronics industry.

Among the problems solved as described in the brochure are those of:

(1) Designing a 20-w amplifier for p-a systems that fits into a 50 cu in. package.

(2) Designing a transistorized plug-in high-gain audio amplifier that is directly interchangeable with a vacuum-tube unit.

Detailed descriptions and inside photographs of the units designed by Universal to solve these problems appear in the free brochure. **Circle 511 on Reader Service Card.**

**Precision Roller-Lever Basic Switch.** Micro Switch, a Division of Minneapolis-Honeywell Regulator Co., Freeport, Ill. Data sheet

127 illustrates and describes a low pretravel, high overtravel, roller-lever actuator basic switch. New uses, contact arrangement, characteristics, electrical rating, list price and discount schedules are included. **Circle 512 on Reader Service Card.**

**Millisecond Operations Recorder.** Fischer & Porter Co., Hatboro, Pa. Catalog 30A1400 illustrates and describes a transistorized millisecond operations recorder. Outstanding features and specifications are given. **Circle 513 on Reader Service Card.**

**Semiconductors.** Transatron Electronic Corp., Wakefield, Mass. A six-page folder contains illustrations, chief features and specifications for a line of silicon transistors, diodes, rectifiers and regulators, and germanium diodes and transistors. **Circle 514 on Reader Service Card.**

**Limit Controllers.** Daytronic Corp., 216 South Main St., Dayton 2, Ohio. A new, 2-color 4-page folder describing models 561 and 562 limit controllers is now available. The folder describes in detail the use of Daytronic limit controllers for automatic control of weight, size, force, thickness, pressure, flow, acceleration, stress, strain or other physical quantities. A number of suggested applications are shown. Specifications of standard models and description of selectable options is given. **Circle 515 on Reader Service Card.**

**Semiconductor Solder Data.** Anchor Metal Co., Inc., 966 Meeker Ave., Brooklyn 22, N. Y. As a service to the electronic and allied industries, the company has made available a handy reference chart for semiconductor soldering applications.

The reference chart offers phase diagrams for the more popular Anchor soldering alloys used in semiconductors. In addition, a list of high-purity elements is included, indicating the purity of each element that is available. **Circle 516 on Reader Service Card.**

This  
precision



Potentiometer easily withstands



**CYCLE VIBRATION!**

another result of  
"DYNAMIC  
BALANCE" \*

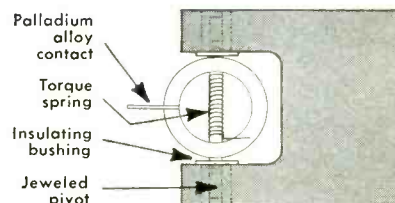

New electromechanical innovation assures potentiometer performance of highest precision . . . electronically *and mechanically!* Arm is dynamically balanced on shaft . . . contact assembly dynamically balanced on arm. The "maximum precision" potentiometer offering wanted performance characteristics:

- Continuous operation at 2000 cycle vibration at 30 g's
- 5,000,000 cycle life
- Up to 3,425 RPM operating speeds

\*Patent Pending

Write today  
for complete  
information  
on the 1000  
Series

electronic components division

**Chicago Aerial Industries, Inc.**

10265 Franklin Avenue • Franklin Park, Illinois

CIRCLE 251 READERS SERVICE CARD

# Plants and People

Edited by WILLIAM P. O'BRIEN

Electronics manufacturers expand plants and facilities by acquisition, leases or new construction. Top engineers and executives in the industry are promoted and move to new responsibilities. Audio Engineering Society elevates member

## Johnson, Others Honored By Franklin Institute

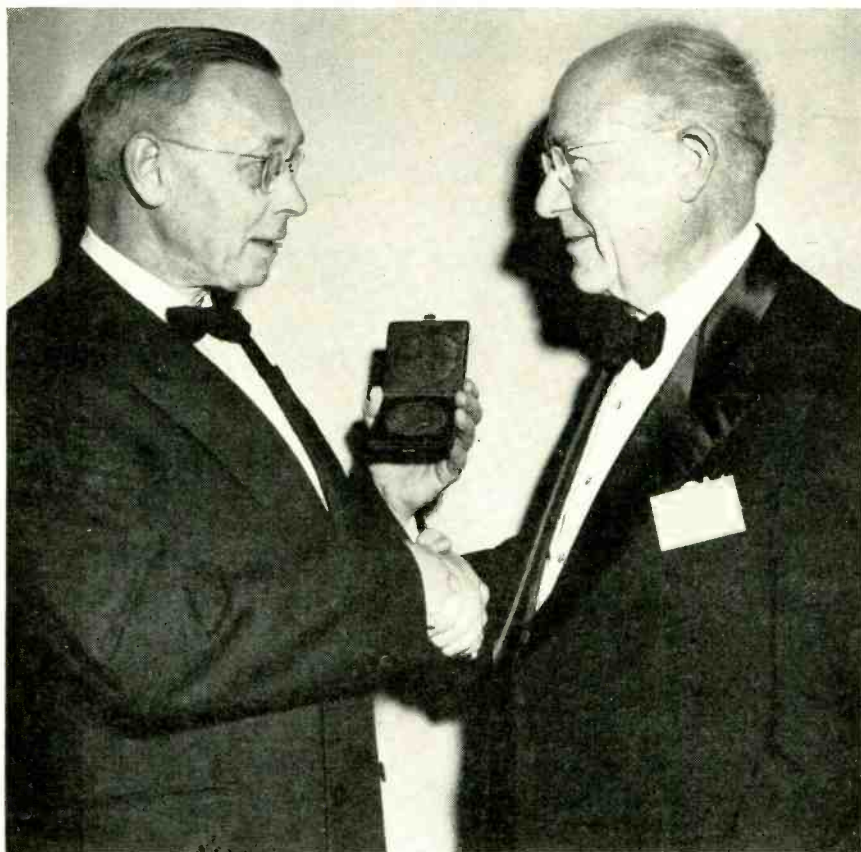

J. B. Johnson (left) accepts Longstreth Medal from S. W. Rolph, Franklin Institute president

DR. JOHN BERTRAND JOHNSON, head of the physics department, Thomas A. Edison Laboratory of McGraw-Edison, West Orange, N. J., was recently awarded the Edward Longstreth medal of the Franklin Institute in Philadelphia, Pa.

The honor was bestowed upon Dr. Johnson for his work leading to the understanding, recognition and measurement of noise in conductors caused by heat generated by molecular action. He established the fundamental nature of the noise which occurs in any kind of electrical conductor or resistor. The chief theoretical value of his

experiments is that it makes possible a determination of the lower limit of attainable noise reduction so that the impossible will not be expected of an amplifier.

A pioneer in the study of cathode-ray tubes, Dr. Johnson, who has been associated with the Edison Laboratory since 1952, developed the first sealed-off cathode ray oscillograph tube for general laboratory use.

Others in our field honored at the Medal Day ceremony included: Sir Robert A. Watson-Watt of Toronto. He received an Elliott Cresson Medal for his leadership in the de-

velopment of radar systems.

A John Price Wetherill Medal went to Warren W. Carpenter of Winter Park, Fla., for important contributions to the technology of modern telephone switching.

William G. Pfann of the metallurgical research department of the Bell Telephone Laboratories, Murray Hill, N. J., received the Francis J. Clamer Medal in recognition of his discovery and application of zone refining metals and other crystalline substances.

Dr. Robert M. Page and Leo C. Young, both of the USNRL, Washington, D. C., were awarded the Stuart Ballantine Medal for their development of the first pulse radar system in the U. S.

## Fairchild Enters Semiconductor Field

FAIRCHILD SEMI-CONDUCTORS CORP. has been formed in Palo Alto, Calif., for the development and production of silicon diffused transistors and other semiconductors, we are told by Fairchild Camera and Instrument Corp., the sponsoring organization.

The new company was organized around a group of senior scientists and engineers who have been working together in the development of transistors and other semiconductor devices. With four divisions already associated with missile and satellite instrumentation, semiconductors are expected to enhance Fairchild Camera's advances in that effort.

The research group of the new company will be headed by Dr. Robert Noyce, formerly of the Re-



# Proceedings of the IRE

looks into outer space with **RADIO ASTRONOMY**

January 1958 Special Issue

**RADIO ASTRONOMY** is responsible for a rich harvest of new information about the sun and certain solar phenomena, meteors and meteor showers recorded in broad daylight, the galaxy of stars of which our own sun is a part, and other galaxies infinitely distant from us. Regions of the universe invisible to the eye and the photographic plate can now be seen via their measurable radiation at radio wave lengths. New developments in antennas, propagation, low-noise receivers and the ionosphere are occurring because of progress in radio astronomy.

Here is the revolutionary technique which is carrying us to uncharted regions of the universe. Discoveries in this field during the last decade have created another vitally important branch of science.

**PAPERS BY KARL JANSKY** in issues of PROCEEDINGS OF THE IRE during the early 1930's first reported the existence of radio waves emanating from outside the earth's atmosphere . . . now PROCEEDINGS publishes the first full discussion of radio astronomy, its current state and future prospects, written by the leading authorities from all over the world.

**Special January Issue Contains Nearly 400 Pages Summarizing All That Is Known About Radio Astronomy**

- "On Karl Jansky" by C. M. Jansky, Jansky & Bailey.
- "Recollections of Early Experiments in Radio Astronomy" by G. Reber, Hawaii.
- "Radar Echos From the Moon at a Wave Length of 10 cm" by B. S. Yapple, et al, N. R. L.
- "Excitation of the Hydrogen 21 cm Line" by G. B. Field, Princeton.
- "Extra Galactic 21 cm Line Studies" by H. S. Heesch, Greenbank Nat. Obs., N. H. Dieter, Harvard.
- "Radio Stars and the Milky Way at 440 mc" by N. G. Roman & B. Yapple, N. R. L.
- "A High Resolution Radio Telescope for Use at 3.5 M" by B. Y. Mills, et al, Australia.
- "The Sydney 19.7 Mc/s Radio Telescope" by C. A. Shain, Australia.
- "Radio Telescope Antennas of Large Aperture" by J. D. Kraus, Ohio State.
- "An Antenna Array for Studies in Meteor and Radio Astronomy at 13 Meters" by P. B. Gallagher, Stanford U.
- "A Wide Band Antenna System for Solar Noise Studies" by H. Jasik, Jasik Labs.
- "Radio Interferometry of Discrete Sources" by R. N. Bracewell, Stanford U.
- "A Polarimeter in the Microwave Region" by K. Akabane, Tokyo Obs.
- "The Cornell Radio Polarimeter" by M. H. Cohen, Cornell.
- "10.7 cm Solar Radio Flux Measurements" by W. J. Medd & A. E. Covington, Canadian Res. Council.
- "Absorption Techniques as a Tool for 21 cm Research" by A. E. Lilley & E. F. McClain, Yale.
- "Lunar Thermal Radiation at 35 KMC" by J. E. Gibson, N. R. L.
- "Planetary and Solar Radio Emission at 11 Meters Wavelength" by J. D. Kraus, Ohio State.

MORE THAN 45 ARTICLES IN ALL

## Proceedings of the IRE

1 East 79th Street, New York 21, N. Y.

Enclosed is \$3.00.

Enclosed is company purchase order for the January, 1958 issue on RADIO ASTRONOMY.

NAME \_\_\_\_\_

COMPANY \_\_\_\_\_

ADDRESS \_\_\_\_\_

CITY & STATE \_\_\_\_\_

One copy at \$1.25 to IRE members, domestic and foreign. \$3.00 to non-members; \$2.40 to public libraries, colleges and subscription agencies; postage prepaid to U. S. and Canada; 25c additional per copy to other countries.



**The Institute  
of Radio Engineers**

1 East 79th Street • New York 21, N. Y.

search Division of Philco Corp. President of the new corporation is H. E. Hale, a v-p of Fairchild Controls Corp. and general manager of the Components Division.

Richard Hodgson, executive v-p of Fairchild Camera and Instrument Corp., is chairman of the board.

First products to be offered will be a high speed computer transistor

to be followed by transistors which will serve the applications of vhf power oscillators, vhf amplifiers, and very high power applications at lower frequencies.

## Autometric Names Operations Analysis Head

HERBERT BOMZER has been appointed director of operations analysis for Autometric Corp. The outfit was organized in May, 1957 as a subsidiary of Paramount Pictures Corp. and is a research and development organization whose main interests are developing equipment and techniques for reconnaissance systems, automatic processing and analysis of intelligence data, multicolor presentations, radar simulation equipment and other forms of specialized electronic systems.

Bomzer in his new capacity will

be responsible for analysis and coordination of the company's research and development efforts. He is a former projects supervisor for Ford Instrument Co., where he had been concerned with computer design problems, wave propagation theories, and the design of instruments and techniques used in the fields of reconnaissance and simulation.

## Hardwick, Hindle Inc. Buys George Rattray

GEORGE RATTRAY & Co., INC., Richmond Hill, N. Y., manufacturer of precision potentiometers, an-

nounces that it has become a wholly owned division of Hardwick, Hindle, Inc. of Newark, N. J., a subsidiary of American Seal-Kap Corp. George Rattray, founder of the company, will continue as president.

The new association will enable the Rattray Co. to expand their engineering staff and facilities, and will permit completion of the development and manufacture of a full line of precision potentiometers. In addition, both technical and advisory services to customers will be expanded and improved. Rattray & Co. potentiometers will now be marketed throughout the country.

## ERA Acquires Enlarged Facilities in Cedar Grove



Electronic Research Associates' enlarged facilities

ELECTRONIC RESEARCH ASSOCIATES, INC., manufacturer of tubeless and semiconductor products, formerly located in Nutley, N. J., announces the acquisition of new and enlarged facilities located in Cedar Grove, N. J.

These new facilities represent a several-fold enlargement of floor

area. The new plant will accommodate increased production, engineering and processing facilities for the company's line of semiconductor and transistorized converters, power packs, transistor test equipment, and transistorized apparatus.

The plant facilities are air-con-

ditioned, one-story modern brick construction, and include several acres of additional ground to permit further expansion. Facilities previously located in the Nutley area will be maintained so as to accommodate the company's other manufacturing operations.

(Continued on page 320)

Lumped-constant  
**DELAY LINES**  
 the way you want them!



"Firecracker"  
 packaging  
 1/2 actual size



For standard 19-inch rack mounting

**Epsco has met these limits — what are yours?**

- Delays from 20 millimicroseconds to 200 millimicroseconds or longer, if desired.
- Delay to rise time ratios up to 50.
- Delay tolerance of 0.1% or 10 millimicroseconds, whichever is greater.
- Characteristic impedance tolerance of 1% from 50 to 5,000 ohms.
- Spurious signals measured at the terminated input after twice delay time can be held to less than 1%.
- Temperature compensation to  $\pm 10$  ppm/ $^{\circ}\text{C}$  over a range of  $-50^{\circ}\text{C}$  to  $+150^{\circ}\text{C}$ . (Patent pending)

If you're involved with lumped-constant delay lines, draw closer. Epsco has application-engineered a wide range of such devices for coding, decoding, telemetering systems, speech synthesis, auto and cross-correlation, trigger delay, pulse forming circuits, etc.

Unique packaging is our meat: just tell us your space, configuration and mounting requirements and performance specifications. If you are concerned with environmental problems, we will test your delay lines for shock, vibration, moisture, altitude, temperature, etc., in Epsco's own in-plant environmental laboratory.

Custom engineering-production of electronic components (shift registers, magnetic logic elements, delay lines, special pulse transformers, etc.) is our specialty. You can count on Epsco's cooperation and conscientious service right down the line. Your inquiry will receive prompt action. Write for Delay Lines Technical Bulletin DL-55.

Epsco, Incorporated, Dept. R127, 108 Cummington St., Boston 15, Mass.



START-TO-FINISH cooperation . . . an Epsco guarantee

**COMPONENTS**

**the specs are the proof . . .**  
**the BEST BUYS are EICO**  
 for COLOR & Monochrome TV servicing

**NEW COLOR**  
 and Monochrome  
 DC to 5 MC LAB & TV  
 5" OSCILLOSCOPE

#460  
 Factory-wired  
 and tested \$129<sup>50</sup>  
 Also available as kit \$79<sup>95</sup>

• Features DC Amplifiers!

Flat from DC-4.5 mc, usable to 10 mc. VERT. AMPL.: sens. 25 rms mv/in; input Z 3 megs; direct-coupled & push-pull thruout; K-follower coupling bet. stages; 4-step freq. compensated attenuator up to 100:1. SWEEP: perfectly linear 10 cps-100 kc (ext. cap. for range to 1 cps); pre-set TV V & H positions auto. sync. ampl. & lim. PLAS: direct or cap. coupling; bal. or unbal. inputs; edge-lit engraved lucite graph screen; dimmer; filter; bezel fits std. photo equip. High Intensity trace CRT, 0.06 usec rise time. Push-pull hor. ampl., flat to 100 kc, sens. 0.6 rms mv/in. Built-in volt. calib. Z-axis mod. Saw-tooth & 60 cps outputs. Astig. control. Retrace blanking. Phasing control.

**NEW TV-FM**  
**SWEEP GENERATOR**  
 & MARKER

#368  
 Factory-wired  
 and tested \$119<sup>95</sup>  
 Also available  
 as kit \$69<sup>95</sup>

Entirely electronic sweep circuit (no mechanical devices) with accurately-biased in-circuit for excellent linearity. Extremely flat RF output; new AGC circuit automatically adjusts osc. for max. output on each band with min. ampl. variations. Exceptional tuning accuracy; edge-lit hairlines eliminate parallax. Swept Osc. Range 3-216 mc in 5 fund. bands; Variable Marker Range 2-75 mc in 3 fund. bands; 60-225 mc on harmonic band. 4.5 mc Xtal Marker Osc., xtal supplied. Ext. Marker provision. Sweep Width 0-3 mc lowest max. deviation to  $\approx$ 30 mc highest max. dev. 2-way blanking. Narrow range phasing. Attenuators: Marker Size, RF Fine, RF Coarse (4-step decade). Cables: output, scope vertical.

**NEW DYNAMIC**  
**CONDUCTANCE**  
 Tube &  
 Transistor Tester

#666  
 Factory-wired  
 and tested \$109<sup>95</sup>  
 Also available  
 as kit \$69<sup>95</sup>

COMPLETE with steel cover and handle.

SPEED, ease, unexcelled accuracy & thoroughness. Tests all receiving tubes (and picture tubes with adapter). Composite indication of Gm, Gp peak emission. Simultaneous sel of any 1 of 4 combinations of 3 plate voltages, 3 screen voltages, 3 ranges of continuously variable grid voltage (with 5% accurate pot). New series-string voltages; for 600, 450, 300 ma types. Sensitive 200  $\mu$ a meter. 5 range meter sensitivity (1% shunts & 5% pot.) 10 SIX-position lever switches: free point connection of each tube pin. 10 push-buttons rapid insert of any tube element in leakage test circuit & speedy sel. of individual sections of multi-section tubes in merit tests. Direct-reading of inter-element leakage in ohms. New gear-driven rollchart. Checks n-p-n & p-n-p transistors; separate meter readings of collector leakage, current & Beta using internal dc power supply. CRA Adapter \$1.50

See the 50 EICO models IN STOCK at your neighborhood distributor. Write for FREE Catalog E-12

Prices 5% higher on West Coast

**EICO** 33-00 NORTHERN BLVD.,  
 LONG ISLAND CITY 1, N. Y.

CIRCLE 256 READERS SERVICE CARD

## DuMont Names Divisional G-M



Frederick H. Guterman

APPOINTMENT of Frederick H. Guterman as general manager of the Technical Products Division, Allen B. DuMont Laboratories, Inc., has been announced. Prior to joining DuMont, he was assistant vice president, sales and planning, at American Bosch Arma Corp.

Guterman will be responsible for overall sales and marketing of oscilloscopes and associated electronic test equipment, automotive test equipment, industrial tv systems, and two-way mobile radio systems.

## Leach Appoints Director Of Engineering

ROBERT R. BEACHLER, JR., has been appointed director of engineering for the Leach Corp., Los Angeles, Calif.

In addition to guidance and direction of the engineering activities of the Leach Relay and Inet Divisions in the design and production of relays and ground power units for aircraft and missiles, Beachler will be responsible for management of the Special Products Division, the future product development unit of the corporation.

Beachler had been associated with the Engineering Research Laboratory of North American Aviation, Inc., for the past 17

# ACME ISONEL WIRE

Plus Acme #150 VARNISH  
 Equals Class B

Equals MIL-T-27A Class S

Freed Transformer Co., Inc., Brooklyn, N. Y., a leader in engineering and manufacturing of transformers and reactors for the electronics industry, has found in the above equation the solution to the manufacturing and performance problems of Class B (MIL-T-27A, Class S) Commercial and Military units

Acme Isonel Wire is a Class B (MIL-T-27A Class S) wire. However, optimum insulation system performance can only be achieved when this wire is impregnated with a compatible varnish. Acme #150 is that varnish.

Acme #150 Varnish does not require a high temperature cure. It has excellent resistance to oils. Acme #150 Varnish meets all the requirements of specifications MIL-V-1137A, Class CB, Type M for government equipment. In fact, it exceeds the heat resistance requirements of this specification by 50%.

Acme #150 Varnish improves thermal stability, while maintaining dielectric strength when used in Class B (MIL-T-27A Class S) windings.

## ACME WIRE CO.

NEW HAVEN, CONN.

MAGNET WIRE • COILS  
 VARNISHED INSULATIONS  
 INSULATING VARNISHES  
 AND COMPOUNDS



CIRCLE 257 READERS SERVICE CARD

December 1, 1957 — ELECTRONICS

years, successively holding positions of engineer, supervisor, group leader, and director of the laboratory. He has also been active as a consultant in instrumentation and electroacoustics.

### Zwerin Assumes IRC Post

INTERNATIONAL RESISTANCE Co., Philadelphia, announces the appointment of Martin I. Zwerin to special representative for market development of new products.

Prior to joining IRC, Zwerin was



Martin I. Zwerin

a staff member of the Curtiss Wright Corp., handling market research and advertising. He was previously associated with Westinghouse Electric International Co. as sales engineer, and with the Philco Corp. as electronics engineer.

### GE Enlarges Computer Setup

GENERAL ELECTRIC Co. has started expansion to double size of its computer division plant at Phoenix, Ariz. The work requires an addition of 30,000 sq ft of building at a cost of \$225,000. Target date for completion is Jan. 1.

At the same time the company announced optioning of 160 acres

# PART COST CUT 1/2

with **GRC**  
die cast  
tiny parts!

Range timer part made by Gries costs half as much as die-cast by the customer

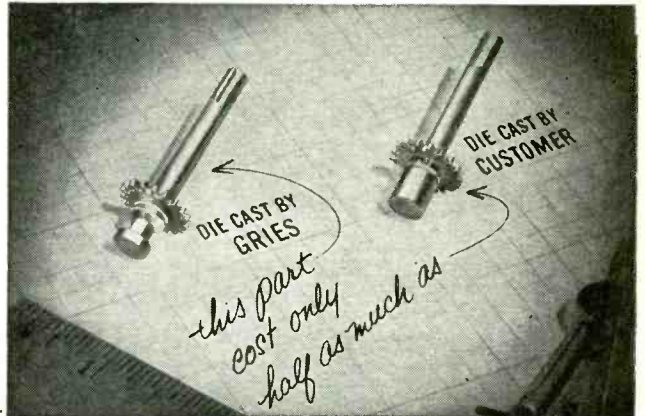

Quick deliveries on quantities of 100,000 to many millions.

**NO MINIMUM SIZE!**

Maximum weight: 1/2 oz.

Maximum length: 1 3/4"

Send today for bulletin.

Many manufacturers have learned that GRC specialized techniques and facilities have cut the cost of tiny components for their products 50% and more compared with production in their own plants. Parts like the slotted gear shaft illustrated are die cast to precise specifications—trimmed, ready for use—in one automatic operation. Consult Gries about cost-cutting components for your products.



**GRIES REPRODUCER CORP.**

151 Beechwood Avenue, New Rochelle, N. Y. • New Rochelle 3-8600

CIRCLE 258 READERS SERVICE CARD

## PHILLIPS HERMETIC SEALS

The Man from Phillips is the man to see for glass-to-metal seals — any type, any size, any quantity, standard or custom-engineered. Exceptionally fast delivery. Write for catalog.

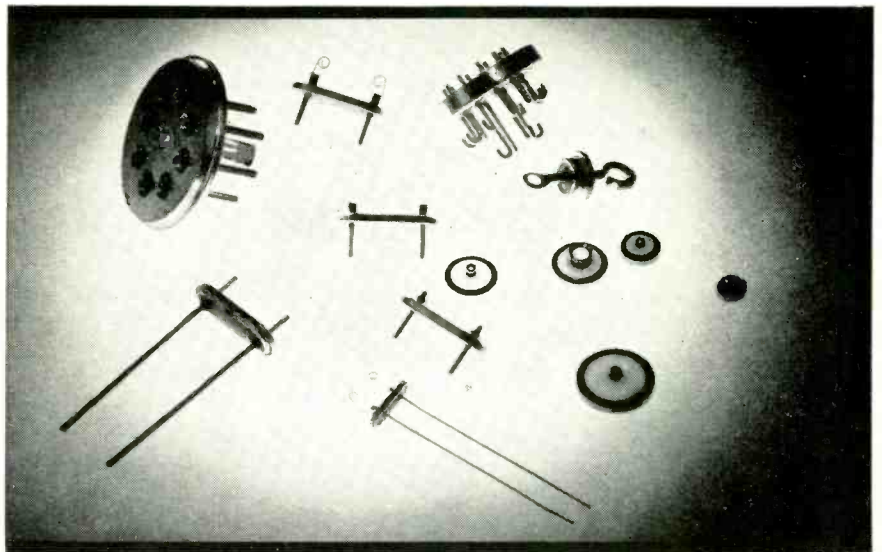

Phillips Control Corporation, Joliet, Illinois — AN ALLIED PAPER CORPORATION  
SUBSIDIARY — SALES OFFICES: NEW YORK - PHILADELPHIA - BOSTON - SAN FRANCISCO - DENVER - SANTA MONICA - WASHINGTON - WINSTON SALEM - CLEVELAND - DALLAS - SEATTLE - KANSAS CITY - ST. LOUIS - DETROIT

NOW...A

# NEW CURVE TRACER

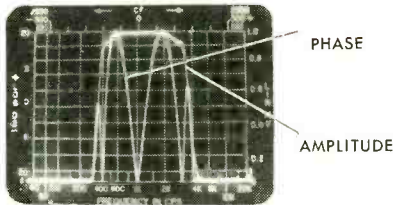

that conveniently measures **both**  
**PHASE & AMPLITUDE**  
 response characteristics  
 on identical frequency scales.



## PANORAMIC'S unique SONIC PHASE & AMPLITUDE RESPONSE ANALYZER

MODEL  
**PA-1**

A multi-purpose instrument, the PA-1 quickly and conveniently analyzes two important characteristics of audio devices and networks . . . phase shift and amplitude response vs. frequency.



The PA-1 operates with the widely accepted Panoramc Sonic Analyzer LP-1a, a proven performer. Phase angle and amplitude readout appear as single line curves on identical frequency scales . . . either on the screen of the LP-1a or on its auxiliary chart recorder, Model RC-3. Selection of the type of analysis is quickly obtained with a front panel control. Overall frequency range is from 20 cps to 22.5 kc.

### ADVANTAGES

#### Amplitude/Frequency Response

- Provides virtually unlimited dynamic range
- Indicates response to fundamental frequencies only
- Discriminates against hum
- Minimizes the effect of noise

#### Phase Angle/Frequency

- As an attenuation curve tracer: measures "stop-band" regions in excess of -100 db
- As a swept phase shift curve tracer: reads out ordinates on vertical linear scale calibrated to 180° full scale . . . or magnifies small phase shifts for detailed study by expanding a fewer number of degrees to full scale
- Lag and lead sense determined by an internal circuit

The PA-1's many advantages are still further amplified when used in combination with other instruments forming a part of Panoramc's unique response tracing system.

Panoramc's Triangular Wave Generator TW-1 generates a continuously variable linear bidirectional swept frequency enabling the establishment of the proper rate of scan to insure precise measurement of non-transient response characteristics.

Panoramc's Signal Alternator SW-1 presents two signals at alternate intervals making possible the injection of a marker or the comparison of two similar responses. Variations are instantly visible.

Write, wire, phone TODAY for detailed specification bulletin on the PA-1.

Panoramc instruments are PROVED PERFORMERS in laboratories, plants and military installations. Find out how a Panoramc instrument can help you. Send for our new CATALOG DIGEST and ask to be put on our regular mailing list for the PANORAMIC ANALYZER featuring application data.



the pioneer  
is the leader



PANORAMIC RADIO PRODUCTS, INC.

530 South Fulton Avenue, Mount Vernon, N. Y., Phone: OWens 9-4600

Cables: Panoramc, Mount Vernon, New York State

of land in Deer Valley, near the present temporary plant site, as location for a permanent garden-type factory site.

The GE computer division, which headquarters at Phoenix, was recently awarded a \$1½ million annual contract to operate a computer center at the Army ballistics agency in Huntsville, Ala. GE already operates a computer center at Arizona State College, at Tempe. Some of the computation work of the new center will be handled at the Arizona center. Huntsville is the home of Redstone, the Army's missile development center.

## RCL Expansion Under Way

RADIATION COUNTER LABORATORIES, INC., Skokie, Ill., has started an expansion program which will double the size of its present plant. Completion of the 64,000 sq ft addition will increase RCL's present production capacity 100 percent.

The present trend toward nuclear data processing using instrumentation typified by RCL's 256-Channel Analyzer and the augmented demands for radiation sensing elements has forced the organization to expand to meet the present and also the expected future needs for its equipment.

RCL's gross sales the last two quarters were in excess of a two million dollars per year rate and were the highest in the company's ten year history.

## Webcor Makes Test Facilities Available

THE Government Division of Webcor, Inc., Chicago, Ill., plans to make available its extensive environmental and general test facilities to serve the testing needs of industry. In the past, these facilities have been used by Webcor exclusively for its own developmental and contract work. At present, these laboratories are being utilized to test timers, signal generators,

data recorders, guidance systems, direction finders, keyers, and classified Military equipment, as well as Webcor's commercial products.

The laboratory will furnish facilities for testing commercial items in addition to performing tests on qualification acceptance, inspection and quality assurance tests to fulfill requirements of military specifications.

Richard F. Hahn will manage the laboratory facilities in this expanded program.

### Control Data Hires A Washington Director

HENRY S. FORREST has been appointed to the position of director of government service engineering and manager of the eastern office, located at Washington, D. C., for Control Data Corp., Minneapolis, Minn.

In his new position, Forrest will maintain liaison with government



Henry S. Forrest

clients in research and development activities of the firm. Control data will be active in the fields of electronic data processing and control, including advanced weapons and guided missile systems, air traffic control, and air defense.

Forrest has been associated for the past 10 years with Sperry Rand's Univac Division as Washington manager for research and development and special systems sales, and with one of its predeces-



This new Speer Packaged Assembly Circuit offers you a wide variety of custom, preassembled units of high-quality components for use in conjunction with printed board applications.

P.A.C. permits the insertion, *as a group*, of a full range of capacitors and resistors in simple or complex circuitry. Each P.A.C. is based on components of uniform dimensions,  $\frac{1}{8}$ " diameter and  $\frac{3}{8}$ " long. Component availability includes Jeffers tubular ceramic capacitors and Speer fixed composition resistors, providing wide circuit flexibility in a single P.A.C. unit.

#### ADVANTAGES OF SPEER P.A.C.

- *Simplifies chassis design and assembly*
- *Reduces printed circuit board area and insertion operations*
- *Permits easy and low-cost component change-over to accommodate circuit revisions*
- *Broad choice of characteristics—low capacitance temperature compensating units and high capacitance bypass capacitors mounted in same P.A.C. unit*
- *Isolation of individually mounted units provides low shunt capacitance across resistors*
- *Pretested components achieve unusually close tolerance assembly*

Learn more about the new Speer P.A.C.  
For information write to:

**JEFFERS ELECTRONICS DIV.**

Speer Carbon Co. Du Bois, Pennsylvania



# HIGH RESISTANCE MEGOHMMETER



- ★ Up to 50,000,000 megohms!
- ★ Test voltage variable 100-600 vdc!
- ★ Uncrowded 4½" meter scale!
- ★ Automatic capacitor discharge!
- ★ Safe test terminals!
- ★ Only \$365!

Here's the only high resistance megohmmeter selling at \$365 with features not found on instruments selling for twice as much. Measuring range up to 50,000,000 megohms to meet the requirements of recent advances in insulating materials. The L-7 Megohmmeter is housed in a hardwood case with recessed vertical panel and convenient carrying handle.

Industrial Instruments has a wide selection of megohmmeters for both laboratory and high-speed production testing. Choose the model that best suits your needs from this table of specifications.

Model	TEST Voltage	RANGE		POWER Consumption	PRICE
		Low	High		
L-2A	200 fixed	1 meg.	100,000 meg.	40 watts	\$200
L-4A	200 and 500 fixed	1 meg. 2.5 meg.	100,000 meg. 250,000 meg.	52 watts	\$230
L-6B	100 to 600*	1 meg.	100,000 meg.	82 watts	\$295
L-7	100 to 600*	1 meg.	5x10 <sup>11</sup> ohms	75 watts	\$365

\*Continuously variable, built-in voltmeter for accurate setting.

Write today for complete catalog of Electrical Test Equipment manufactured by...



**Industrial  
Instruments Inc.**

89 Commerce Road, Cedar Grove, Essex County, N. J.

CIRCLE 262 READERS SERVICE CARD

sor organizations, Engineering Research Associates, Inc., of St. Paul.

With ERA he served as the Washington representative and in several engineering assignments. Before that, Forrest held electronic engineering posts with the Navy's Bureau of Ships and the Naval Research Laboratory.

## Packard-Bell Hires Liaison Engineer

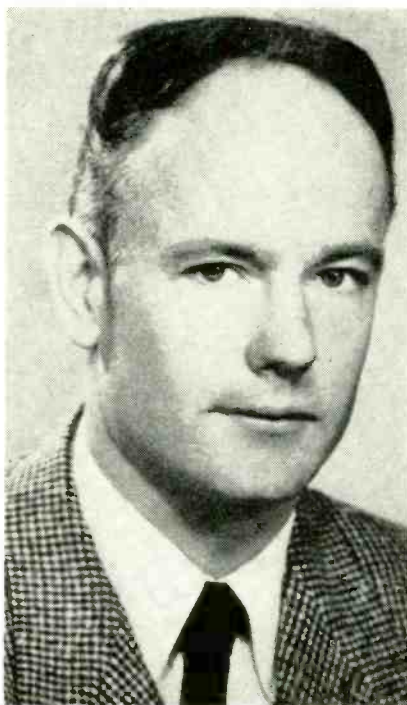

G. M. Russell

GEORGE M. RUSSELL has joined Packard-Bell Electronics as liaison engineer attached to the Washington, D. C., office.

Russell comes to Packard-Bell from RCA Service Co., Inc., where he was engaged in systems engineering at Patrick Air Force Base, Florida. He formerly was associated with RCA in field engineering attached to the U. S. Embassy in The Hague, Netherlands, and prior to his RCA affiliation he was a field engineer for Philco Corp.

## Electro Data Names Allen

JOHN T. ALLEN has been appointed field engineering supervisor in the Dallas, Tex., district of the Electro

## D-B broad band gas-filled cavity wavemeters

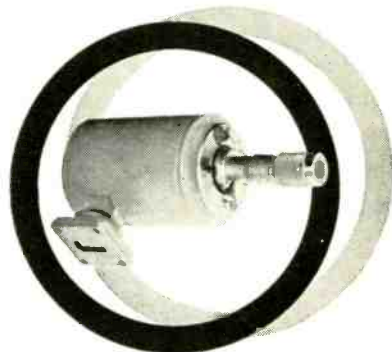

Each instrument covers a wide segment of the total range. Only 11 sizes serve from 2.6 KMC to 90 KMC. Accuracy is so high they may be used as secondary standards. Nitrogen filled and sealed for long life and high Q. Bi-metallic structure provides high degree of thermal compensation. Write for literature.



780 South Arroyo Pkwy. • Pasadena, Calif.  
CIRCLE 263 READERS SERVICE CARD

# COSMIC

ELECTROLYTIC & PAPER  
TUBULAR

Condensers

35 YEARS OF  
"PROVEN  
DEPENDABILITY"

COSMIC CONDENSER CO.  
853 Whittier St., Bronx, N. Y.

PHONE  
LUdlow 9-3360

CIRCLE 264 READERS SERVICE CARD



Data Div. of Burroughs Corp.

Allen is responsible for installation and servicing in the Dallas area of Electro Data equipment—including the Datatron electronic data processing systems and E101 computers.

He joined Electro Data in June, 1956, after serving as an electronic computer customer engineer and an installation technician.

### Elco Acquires Macson Co.

ANOTHER step in the long range expansion program of Elco Corp. was recently reached with the acquisition of Macson Co., Los Angeles, Calif., by Elco's wholly owned subsidiary, Elco Pacific.

With this acquisition Elco is adding a complete line of power connectors to its present line and will also be in a position to give better service to the rapidly growing Pacific industrial area.

### Honer Promoted at G-D Corp.

ROBERT E. HOMER, specialist in electronics and microwave systems for more than a decade, has been appointed chief electronics engineer at Convair (San Diego), a Division of General Dynamics Corp. Honer joined Convair in 1953 as design specialist in charge of the microwave group.

Honer's career has included color tv research immediately following World War II with the Zenith Radio Corp. and research and development work as associate professor of research at Georgia Tech. He has had published numerous articles on antennas and microwave.

### Hunt Becomes Sales Engineer

APPOINTMENT of J. N. Hunt as Atlanta district sales engineer for the Collins Radio Co., Cedar Rapids, Iowa, was recently announced. He had been an associate field engineer for the company be-

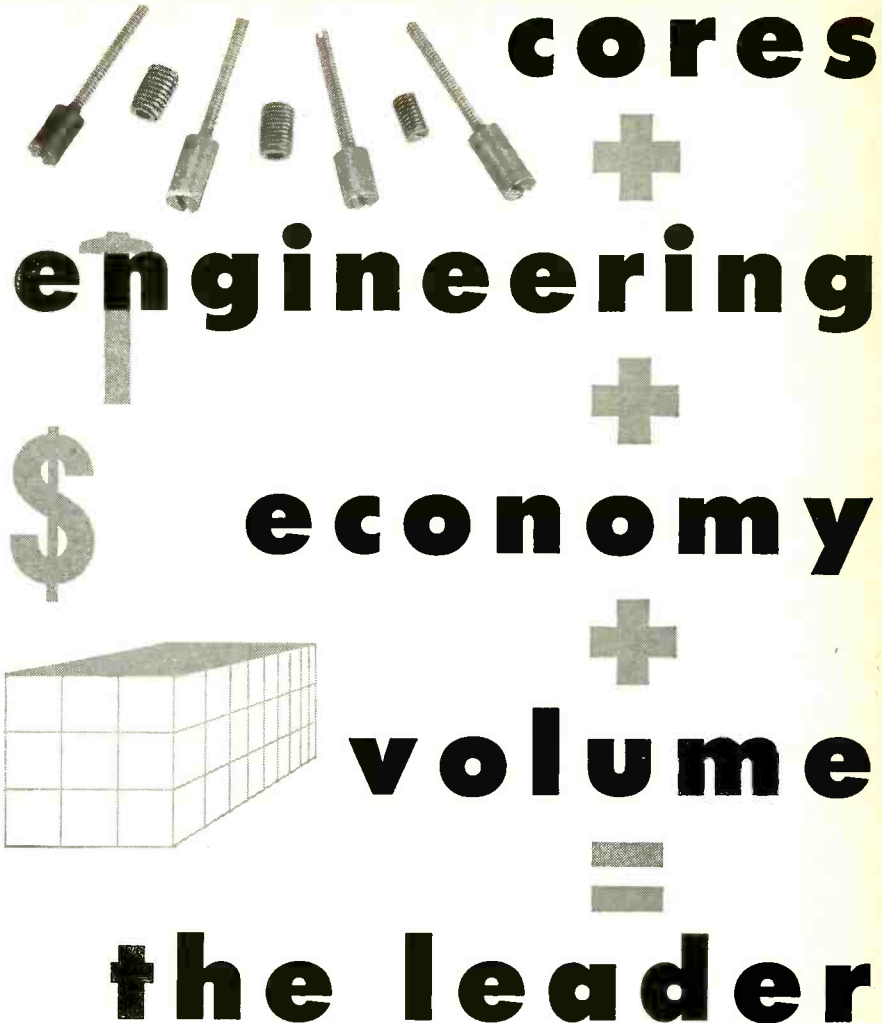

**cores**  
+  
**engineering**  
+  
**economy**  
+  
**volume**  
=  
**the leader**

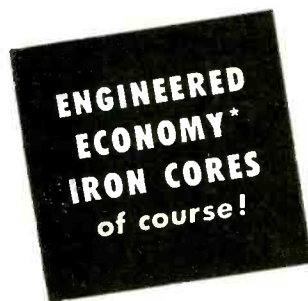

\*trademark

Also, custom iron cores  
to your specifications.

We are proud as the originators of ENGINEERED ECONOMY\* IRON CORES that we have been able to reduce the prices of our products so tremendously in the past few years. This has been achieved through constantly increasing volume production, reduction of costs through improved manufacturing techniques and the use of automation. We now have better and more uniform quality than ever before.

Now, you can select from over 19 types of ENGINEERED ECONOMY\* IRON CORES where previously we had to produce over a hundred. Fewer varieties enables us to stock more and sell at lower prices. We invite your inquiry.

Copyright 1956  
Radio Cores, Inc.

# Radio Cores, Inc.

9540 Tully Avenue Oak Lawn, Illinois





# Welwyn

leaders in the field of high  
stability deposited carbon resistors

Now Offers

## WELCON

### Vitreous Enamelled Miniature Capacitors

**Tolerances:**  
±20%, ±10%, ±5% and ±2%  
(±0.5 uufd at low values)

**Max. Ambient Temperature:**  
150° Centigrade

**Values:**  
18 to 1000 uufd

**Temperature Coefficient:**  
Substantially zero — with spread of  
±40 parts/million/degree C

**Power Factor at 1 mc:**  
better than 0.001

Manufactured in England and Canada

For complete data and specifications write to Dept. AT-12

**Welwyn International, Inc.**

3355 Edgecliff Terrace, Cleveland 11, Ohio

CIRCLE 266 READERS SERVICE CARD

fore receiving this assignment.

Hunt was formerly associated with Lockheed Aircraft as a special course instructor in electronic systems. He also served for 10 years as a communication specialist for the Atlanta and West Point railroad and for two years served in the Navy as an electronic systems specialist.

### Juaire Named Chief Engineer



Phillip Juaire

BUREAU OF ENGRAVING, INC., Minneapolis, Minn., makers of etched circuits, has appointed Phillip Juaire chief engineer in charge of research and product development of its Industrial Division.

Along with his research and development duties, Juaire is also responsible for operation of the Bureau's control laboratory.

### GPE Promotes Garman to V-P

RAYMOND L. GARMAN was recently elected to the office of vice president—engineering and research of General Precision Equipment Corp. He has been technical director of General Precision Laboratory Inc., a GPE subsidiary, since 1945 and has, in addition, held executive positions of increasing responsibil-

## STURGES BATTERIES

### SEE THE FULL POWER!

Sturges nonspill storage batteries are assembled in transparent molded plastic containing cases of ample tensile strength. The interiors of the cells are subject to visual inspection at all times both as to condition and electrolytic level.

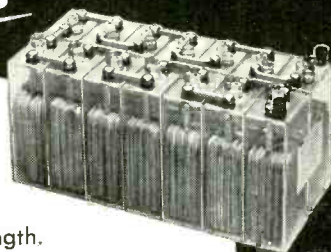

**Type "H" Storage Battery**  
Amp. Hrs.—15  
Voltages from 2 to 28 or as specified  
Weight from 7½ lbs. to 26½ lbs.



**Type "S" Storage Battery**  
Amp. Hrs.—6; Voltages from 2 to 28 or as specified;  
Weight from 12 oz. to 12 lbs.

#### FREE

Write for literature on six different sizes of type "S" and type "H" Batteries; including performance curves, size specifications, etc.

CONSULT US ON ALL  
YOUR SPECIAL BATTERY  
APPLICATION PROBLEMS

STURGES BATTERIES

- ★ Lightweight—Non-Spill (in any position)
- ★ Transparent Molded Plastic Case
- ★ High Output of Watt Hours Per Pound of Battery
- ★ Continuous High Voltage Uniformity While Discharging
- ★ Conforms to Any Amount of Space

manufactured by **ELECTRONIC BATTERIES, INC.**

Bush Terminal Building Number 4 • 28-34 35th Street • Brooklyn 32, New York

## TEST YOUR MAGNETIC CIRCUITS



**RAWSON FLUXMETER  
TYPE 504**

The only portable fluxmeter available which returns rapidly to zero when a single button is depressed. Simple and fast in operation. Convenient and light in weight.

Not limited to a single type of measurement. Has universal application for laboratories or production. Measures strength of magnets and electromagnets, permeability and hysteresis loops for iron and steel, total flux lines in circuit, flux lines developed in air gap, etc.

Has a mechanical clamp to protect the pivots and jewels when in transit.

### RAWSON ELECTRICAL INSTRUMENT COMPANY

111 POTTER STREET, CAMBRIDGE 42, MASS.

CIRCLE 268 READERS SERVICE CARD



## SPADE BOLTS

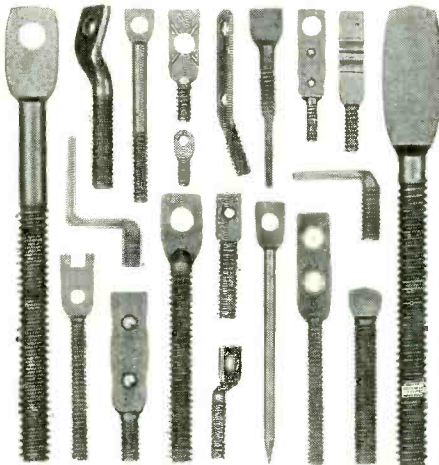

Specialists in designing and manufacturing of all-purpose fasteners and wire forms. Tooled to produce over 1000 styles in any screw size, material, finish, quantity, to your specifications.

Serving Industry for Thirty-Five Years  
— OTHER PRODUCTS —

## Simplex WIRE STRIPPERS & CUTTERS

• TOOLS • DIES • STAMPINGS

Bulletins on complete line on request

**WENCO MANUFACTURING CO.**  
1133 W. Hubbard St., Chicago 22, Ill., U.S.A.

CIRCLE 269 READERS SERVICE CARD

ELECTRONICS — December 1, 1957

PLANTS AND PEOPLE

(continued)

ity, having recently been elected chairman of the board of GPL, an office which he will continue to hold.

In his new position and as chairman of the engineering plans committee, Garman, with technical representatives from other GPE companies, will have general oversight and direction, at the policy level, of the engineering and research activities of the companies in the GPE group, which extend over a wide area of industrial equipment and controls, motion picture and tv equipment, and components and systems for guidance, control and simulation of missiles and aircraft.

### Ace Moves to Larger Quarters

THE Ace Engineering and Machine Co., Inc., Philadelphia, Pa., manufacturers of shielded enclosures recently moved into its newly completed plant at Huntingdon Valley, Pa., a suburb of Philadelphia.

The one-floor air-conditioned offices and plant enclose an area of approximately 18,000 sq ft, and house the executive offices, together with all engineering, design, manufacturing, and testing facilities, under one roof.

Ace Engineering designs and fabricates radio-interference-proof shielded enclosures of copper, bronze, aluminum and galvanized steel screening, as well as sheet metal. The enclosures permit delicate radio frequency tests to be carried out in an area completely free of extraneous radio interference. They are also used to house powerful signal generators and other sources of r-f generation.

### National Beryllia Opens New Plant

NATIONAL BERYLLIA CORP., producing high purity, high density beryllium oxide, alumina oxide, zirconia and thoria configurations, announces the opening of a new production plant in Haskell, N. J. Completely retooled with new and larger furnaces, mixing, grinding

# now!



## Custom Conversion of

## Teflon<sup>o</sup> - Kel-F<sup>†</sup> To Your Order!

Experimentation •  
Design •  
Fabrication •

### To Your Specifications!

- Any Shape
- Any Size
- Any Quantity

Fluorulon Laboratories at Caldwell, N. J. was created for the specific purpose of producing customized products of Teflon<sup>o</sup> and Kel-F<sup>†</sup> plus all standard forms . . .

Extruded      Molded  
Filled          Coatings

Color and Glass Impregnation

## FLUORULON Laboratories

Box 305 Caldwell, N. J.

Phone: CALdwell 6-8228

<sup>†</sup>Kel-F is the registered trade name of the M. W. Kellogg Company.

<sup>o</sup>Teflon is the registered trade name of E. I. du Pont de Nemours & Co.

CIRCLE 270 READERS SERVICE CARD

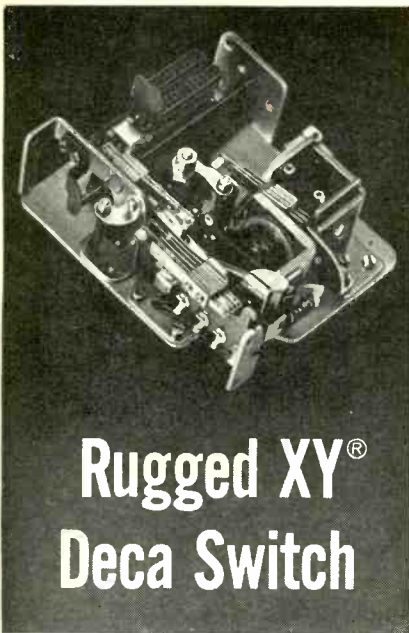

## Rugged XY<sup>®</sup> Deca Switch

### for your selecting and control operations

This direct-drive impulse-controlled stepping switch (reset type) is designed to perform control and selecting functions in industrial and communication applications.

The lightweight Deca Switch offers exceptional reliability and compact ruggedness, plus these added features:

- positive stepping action with special locking device to eliminate bounce of wipers and off-normal contacts when the switch returns to the home position;
- 4 banks of 11 contacts each;
- such time-proven XY advantages as dust-free vertical wire banks, bifurcated wipers, dependable release magnet mechanism, and long-wearing, case-hardened working parts with Parco-Lubrite rust-resistant, oil-retaining finish;
- fast operate and release time.

You can order XY Deca Switches in a wide variety of off normal and release magnet spring combinations to suit your specific requirements. Compact and light, the switches are 4¾" long, 4" wide, 1½" high and weigh 20¼ ounces.

Complete technical details are contained in Bulletin T-5001, available on request.



## STROMBERG-CARLSON

A DIVISION OF GENERAL DYNAMICS CORPORATION  
TELECOMMUNICATION INDUSTRIAL SALES  
11 CARLSON ROAD, ROCHESTER 3, N. Y.  
CIRCLE 271 READERS SERVICE CARD

and extruding equipment, National Beryllia Corp. offers prompt efficient service in the fabrication of precision ceramics for the nuclear energy, rocketry, electronic and metallurgical industries.

### Brown Takes Exec Post at ESC

ESC CORP., Palisades Park, N. J., manufacturers of delay lines, has announced appointment of Col. Charles B. Brown as administrative assistant to the president, Morton Fassberg. Brown retired earlier



C. B. Brown

this year, after more than 30 years of military service.

Since World War II, he has served as executive officer, Signal Center, Ft. Monmouth, N. J.; Army Coordinator, Joint Communications Electronics Committee of the Joint Chiefs of Staff, Washington, D. C.; Chief, Frankfurt Signal Branch, Signal Division of the European Command. He was also Director of Communications Department, Armored School, Fort Knox, Kentucky.

### Dominguez Elected Assistant V-P of IT&T

JOSE D. DOMINGUEZ, recently appointed executive engineer for the telephone and radio operating department of IT&T Corp. in New

## You Get Things Done With Boardmaster Visual Control

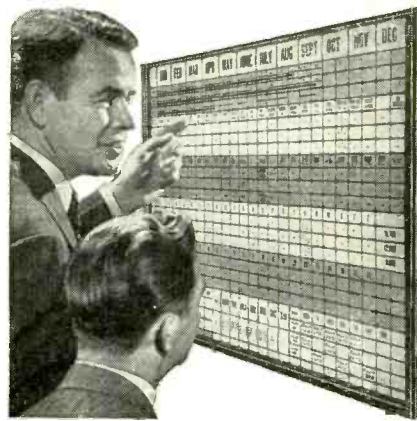

- ☆ Gives Graphic Picture of Your Operations—Spotlighted by Color
- ☆ Facts at a glance — Saves Time, Saves Money, Prevents Errors
- ☆ Simple to operate — Type or Write on Cards, Snap in Grooves
- ☆ Ideal for Production, Traffic, Inventory, Scheduling, Sales, Etc.
- ☆ Made of Metal. Compact and Attractive. Over 200,000 in Use

Complete price **\$4950** including cards

**FREE** 24-PAGE BOOKLET NO. C-50  
Without Obligation

Write for Your Copy Today

**GRAPHIC SYSTEMS**

55 West 42nd Street • New York 36, N. Y.  
CIRCLE 272 READERS SERVICE CARD

# Lepel

## HIGH FREQUENCY Induction HEATING UNITS

**BRAZING  
ANNEALING  
HARDENING  
SOLDERING  
MELTING**

LEPEL Electronic Tube  
GENERATORS—1 KW; 2½ KW;  
5 KW; 10 KW; 20 KW; 30 KW; 50 KW;  
75 KW; 100 KW.  
LEPEL Spark Gap Converters  
2 KW; 4 KW; 7½ KW; 15 KW; 30 KW.

WRITE FOR THE NEW LEPEL CATALOG . . . 36 illustrated pages  
packed with valuable information.

All Lepel equipment is certified to comply with the  
requirements of the Federal Communications Commission.

**LEPEL HIGH FREQUENCY  
LABORATORIES, INC.**  
55th STREET and 37th AVENUE, WOODSIDE 77,  
NEW YORK CITY, N. Y.

CIRCLE 273 READERS SERVICE CARD



he's working  
for you

THIS FELLOW IS TRAINED IN YOUR BUSINESS. His main duty is to travel the country — and world — penetrating the plants, laboratories and management councils . . . reporting back to you every significant innovation in technology, selling tactics, management strategy. He functions as your all-seeing, all-hearing, all-reporting business communications system.

THE MAN WE MEAN IS A COMPOSITE of the editorial staff of this magazine. For, obviously, no one individual could ever accomplish such a vast business news job. It's the result of many qualified men of diversified and specialized talents.

AND, THERE'S ANOTHER SIDE TO THIS "COMPOSITE MAN," another complete news service which complements the editorial section of this magazine — the advertising pages. It's been said that in a business publication the editorial pages tell "how they do it" — "they" being all the industry's front line of innovators and improvers — and the advertising pages tell "with what." Each issue unfolds an industrial exposition before you — giving a ready panorama of up-to-date tools, materials, equipment.

SUCH A "MAN" IS ON YOUR PAYROLL. Be sure to "listen" regularly and carefully to the practical business information he gathers.



McGraw-Hill PUBLICATIONS

ELECTRONICS — December 1, 1957

York City, has been elected an assistant vice-president of the corporation.

He has been with the IT&T System for 30 years in various capacities, and was president of its Puerto Rico Telephone Co. from January 1956 to September 1957, during which time the company carried out the largest program of expansion in its history.

## Applied Research Changes Name, Moves

THE NAME of Applied Research, Inc., Chicago, Ill., industrial research firm, has been changed to Booz, Allen Applied Research, Inc. The firm's headquarters has been moved to 430 Green Bay Road, Kenilworth, Ill.

Booz, Allen Applied Research, Inc., has facilities at Frederick, Md., and Dayton, Ohio. The firm does research and development work on scientific and technical problems for industrial companies and the government.

The company currently is conducting an extended operations research project for the Army, and is also engaged in work for the Navy and Air Force.

For industrial companies, the firm is working on problems involving automation, electronics, thermodynamics, electronic instrumentation for medical experiments, operations research and nuclear technology.

## Company Formed to Serve Computer Industry

A NEW electronic company, Digital Equipment Corp., designed to provide vital testing equipment to the billion-dollar-a-year U.S. computer industry, has been incorporated in Maynard, Mass.

Two recent members of the staff of the Lincoln Laboratory of MIT, both active in the design and application of advanced computers and particularly development of the Semi-Automatic Ground Environment (SAGE) computer systems for the U. S. Air Defense, are or-



## *precisioneered* MAGNETIC AMPLIFIERS

The extra measure of care built into every HYCOR magnetic amplifier can be yours in virtually any standard or special amplifier design. Toroidal construction throughout. Materials and components selected for highest quality. Write for a quick quotation on your exact specifications.

WRITE FOR BULLETIN MA.



INTERNATIONAL RESISTANCE CO.

HYCOR DIVISION  
12970 Bradley Ave., Sylmar, California

CIRCLE 274 READERS SERVICE CARD

# DURANT

Electric "SP"

**PREDETERMINED  
COUNTER**

(COUNTS ELECTRICALLY and CLOSES  
SWITCH AT END OF PRE-SET COUNT)

C · O · U · N · T · S  
ELECTRICALLY

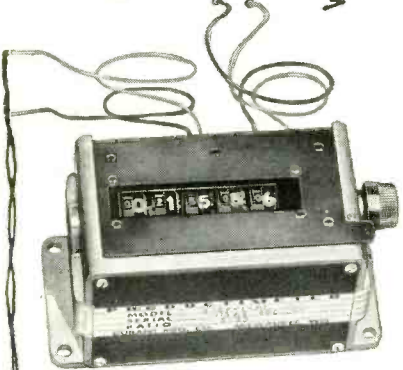

**COMPACT • RUGGED  
FAST • ACCURATE**

Eliminates costly over-runs or time consuming under-runs. Actuated by Photo Electric Cell, Tube, Relay, or Contact Switch. Counter can be located where desired. Predetermined count may be set at any figure to 99,999. Hundreds of applications in all phases of production and instrument work.

Send for Catalog No. 56

**DURANT MFG. CO.**

1912 N. Buffum St., Milwaukee 1, Wis.  
12 Thurbers Ave., Providence 5, R. I.  
Representatives in Principal Cities



**RING  
A BELL**



**LIGHT  
A LIGHT**



**STOP or  
START a  
MACHINE**

**PRODUCTMETERS**  
SINCE 1879 *Count Everything*

CIRCLE 275 READERS SERVICE CARD

PLANTS AND PEOPLE

(continued)

ganizers of the new enterprise. They are Kenneth H. Olsen, president, and Harlan E. Anderson, vice president.

Several factors motivated the establishment of this business. One was the long delays that occur from the time a new idea is developed in a laboratory to its availability in the field. Digital Equipment Corporation hopes to shorten this lag and expects delivery of its first products within 60 days.

## Hunter Named To Exec Post



Gould Hunter

CAPTAIN GOULD HUNTER, USN (Ret), has been named administrative assistant to the president and executive vice-president of Eitel-McCullough, Inc., San Bruno, Calif. This position, as assistant to W. W. Eitel and J. A. McCullough, co-founders of the company, is newly-created because of expansion of the Eimac product line and production facilities.

Hunter, who joined Eitel-McCullough, Inc., in late 1956 as assistant to the vice president, manufacturing, was formerly Commanding Officer of the Navy Electronics Laboratory at San Diego, Calif.

## Robinson Joins Walkirt

JAMES ROBINSON has joined the Walkirt Co., Inglewood, Calif., as chief engineer. He will be respons-

## McGRAW-HILL MAILING LISTS WILL HELP YOU

- Merchandise your advertising
- Conduct Surveys
- Get leads for your salesmen
- Get inquiries about your product or service
- Pin-point geographical or functional groups
- Sell Direct
- Build up weak territories
- Aid Dealer Relations

Direct Mail is a necessary supplement to a well rounded Business Paper Advertising program.

600,000 actual names of the top buying influences in all the fields covered by the McGraw-Hill publications make up our 150 mailing lists. These lists are built and maintained primarily for our own use, but they are available to you for Direct Mail purposes. Pick out a list of YOUR prospect from our Industrial Direct Mail Catalogue.

More and more, progressive companies are using Industrial Direct Mail regularly as an advertising medium. They effectively allocate a portion of their concentrate on the best business publication.

For complete, detailed information about our service, fill in the coupon or write for your copy of our free Business and Industrial Direct Mail catalogue.

*for Results*



**Mc GRAW-HILL**  
DIRECT MAIL LIST SERVICE

Direct Mail Division,  
McGraw-Hill Publishing Co., Inc.  
330 West 42nd St., N. Y. 36, N. Y.

Please forward my free copy of the McGraw-Hill "Industrial Direct Mail Catalogue."

Name \_\_\_\_\_

Company \_\_\_\_\_

Address \_\_\_\_\_

City \_\_\_\_\_ State \_\_\_\_\_

for consistently high purity...

**"LINDE" M.S.C. RARE GASES**  
Trade-Mark  
(Mass Spectrometer Controlled)

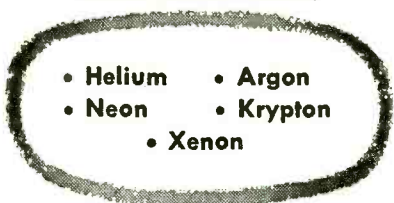

- Helium
- Argon
- Neon
- Krypton
- Xenon

In radar electronic equipment, nuclear radiation counters, cosmic ray cloud chambers, and thyratrons, where the purest rare gases are demanded, LINDE M.S.C. Grade gases meet the specifications. They are produced under continuous mass spectrometer control to assure you of gases of *known* purity and consistently high quality. LINDE, the world's largest producer of gases from the atmosphere, can meet your individual needs of volume, mixture, and container.

For information on the physical, chemical, and electrical properties of these gases, send for the booklet, "LINDE Rare Gases."



### LINDE COMPANY

Division of  
 Union Carbide Corporation  
 30 E. 42nd Street  New York 17, N.Y.

In Canada:  
 LINDE COMPANY, Division of Union Carbide  
 Canada Limited, Toronto

The term "Linde" is a registered trade-mark of Union Carbide Corporation.

CIRCLE 276 READERS SERVICE CARD

quality . . .  
 uniformity . . .  
 service . . .

**GLASS** for  
 HERMETIC SEALING  
 • EPOXY PREFORMS  
 • PRESSED  
 CERAMICS

**mansol**  
 CERAMICS CO.

138 LITTLE ST. | THORNTON HEATH  
 BELLEVILLE, NEW JERSEY | SURREY, ENGLAND

CIRCLE 277 READERS SERVICE CARD

ible for all new product design, the application of Walkirt products, and most phases of production quality control.

Robinson joins the company direct from a four-year association with General Communication Co., Boston, Mass., where he was part of the engineering department's design-development team.

Prior thereto, he was for three years associated with the Canadian Government and concerned with electronic instrumentation on several projects including a geophysical survey project north of the Arctic Circle.

### Senseny Takes New Post

IRON FIREMAN MANUFACTURING Co. recently named George Senseny as director of engineering for its electronics division in Portland, Oregon. He will also head research and development activities.

The division manufactures relays, gyroscopes, slip rings and brushes, heating controls and other electronic parts and instruments.

Senseny went to Portland from New York City where he was vice-president and chief engineer for Rahm instruments after being assistant director of research for Reiber Research Laboratories.

### Schneider Joins Magnavox

APPOINTMENT of Stanley S. Schneider as director of engineering for the Government and Industrial Divisions of The Magnavox Co., Fort Wayne, Ind., has been announced. He comes to Magnavox from the Canadian Westinghouse Co. where he has been employed for the last six years.

### Tracerlab Appoints Hansen

S. S. AUCHINCLOSS, president of Tracerlab Inc., Waltham, Mass., recently announced the appointment of Carl Woodrow Hansen as chief

# Using Thermistors

Edited by

FENWAL ELECTRONICS

This is the third in a series of news columns devoted to thermistors — a device that is super-sensitive to temperature change.

The example in point: power measurement and voltage control.

A bead thermistor can be used to balance a bridge circuit, allowing the thermistor current to be measured and its DC power calculated. This is done with a 2000 Ω bead thermistor in a 200 Ω bridge circuit with a variable resistor in series with the bridge. This will heat the thermistor enough to lower the resistance to 200 Ω and balance the circuit to determine the H.F. power. By applying a source of high frequency power to the thermistor through capacitors this will further heat the thermistor and the bridge will be unbalanced. Then reduce the DC power until the bridge balances again. Calculate the new DC power, and the difference between the two calculations is the H.F. power.

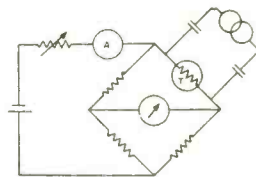

To maintain constant voltage a thermistor with a suitable series resistor "A" can be placed in parallel with a load in a circuit. As the load resistance increases there is a reduced drop across resistor "B." This tends to raise the voltage across the load. The thermistor heats up, reduces its resistance, and more current passes through it and through resistor "B." This brings the voltage across the load back to its original state. Controls like this can maintain as close as 1% voltage regulation over a broad range of load resistance, or any voltage from 1/2 volt to 100 volts can be regulated in this way with suitable circuitry.

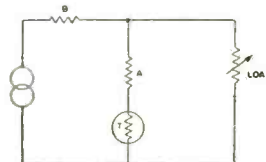

Engineers: these and other thermistor applications are discussed in 12-page catalog EMC-1. Write for your copy to FENWAL ELECTRONICS, INC., 211 Mellen St., Framingham, Massachusetts.



Makers of Precision Thermistors  
 CIRCLE 278 READERS SERVICE CARD

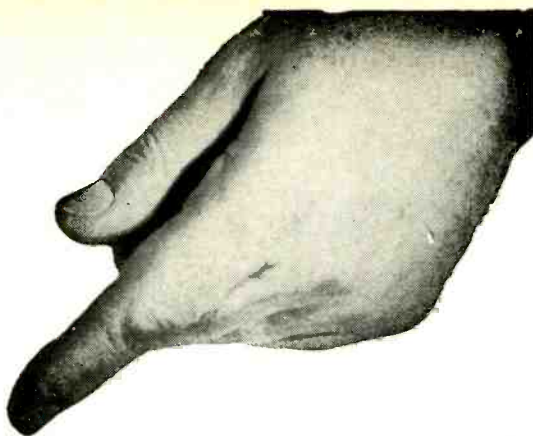

## How to keep informed on the “with what” part of your business

AT YOUR FINGER TIPS, issue after issue, is one of your richest veins of job information — advertising. You might call it the “with what” type — which dovetails the “how” of the editorial pages. Easy to read, talking your language, geared specifically to the betterment of your business, this is the kind of practical data which may well help you do a job quicker, better — save your company money.

Each advertiser is obviously doing his level best to give you helpful information. By showing, through the advertising pages, how his product or service can benefit *you* and *your* company, he is taking *his* most efficient way toward a sale.

Add up all the advertisers and you've got a gold mine of current, on-the-job information. Yours for the reading are a wealth of data and facts on the very latest in products, services, tools . . . product developments, materials, processes, methods.

You, too, have a big stake in the advertising pages. Read them regularly, carefully to keep job-informed on the “with what” part of your business.

### McGRAW-HILL PUBLICATIONS



engineer of the Industrial Products Division.

Hansen was formerly with the X-ray Division of General Electric Co. in Milwaukee, Wisc., where he was project engineer in the Apparatus Engineering Dept.

### General Transistor Names Vice-President



Bernard Jacobs

HERMAN FIALKOV, president of General Transistor Corp., has announced the appointment of Dr. Bernard Jacobs to the newly-created post of vice-president in charge of research.

A specialist in semiconductor development, Jacobs has performed in this capacity at Federal Telephone and Radio Corp. and Radio Receptor Co. He was previously employed by Sperry Semiconductor Division of Sperry-Rand Corp. as head of material research where he was responsible for the development of basic techniques usable in semiconductor device fabrication.

### Instron Builds New Plant

TO MEET stepped up demands for its electronic testing equipment, Instron Engineering Corp., Quincy, Mass., is building a new 25,000 sq ft plant in Canton, Mass. The new



plant will be devoted to the design and production of universal testing machines and other electronic test equipment. The building will also house the company's administrative and engineering offices. At present, Instron employs more than 70 people.

## Company Formed to Grow Single Crystals

THE SINGLE CRYSTAL CORP. OF AMERICA was recently formed in Saxonburg, Pa., to grow single crystals of various materials for electronic, optical and nuclear applications.

Besides the production of growing single crystals, Siccoa is also engaged in research on new single crystals, on its own as well as for industry and government. Siccoa is prepared to engage in any problem concerning single crystal growth since it is staffed with physicists in the solid state, nuclear, electronic and chemical fields.

## Gramer-Halldorson Gets New Chief Engineer

LARRY STINEMAN has been appointed chief engineer for Gramer-Halldorson Transformer Corp., Chicago, Ill. He recently served several years as chief engineer for Merit Coil and Transformer Corp., prior to which time he was senior engineer for Thordarson-Meissner.

## Avien Names Engineering Manager

SEYMOUR RABINOWITZ has joined Avien, Inc., as the company's engineering manager. He was formerly supervising engineer, Atomic Engineering Branch, and chief of product engineering, Picatinny Arsenal, Dover, N. J. He also served on the staff of the Atomic Energy Commission as branch chief in the Special Projects Division, and as electronics engineer on the Technical Advisory Staff of the Commission's New York Office.

In addition to his experience in the field of atomic energy, Rabino-

witz was for a number of years with the Signal Corps serving in a supervisory capacity in several fields including test instrumentation, environmental protection systems, and component engineering. While with the Signal Corps, he was also responsible for the technical administration of one of the Signal Corps' largest radar systems.

## Allegheny Instrument Hires Perino



P. R. Perino

P. R. PERINO recently joined the staff of Allegheny Instrument Co. at Cumberland, Md., as project engineer. He was formerly head of instrument engineering for Aerojet-General Corp. at Sacramento, Calif., and has also headed Proving Ground Instrumentation for Phillips Petroleum Company's Rocket Fuels Division at McGregor, Texas.

## AES Honors Long

ROY A. LONG, research engineer in Stanford Research Institute's engineering research division, has been elected a Fellow in the Audio Engineering Society. Recognition of Long's activities in communications systems was made recently at the annual awards banquet in New York City.

## INCREASED INSULATION BETTER CONNECTIONS

### JONES BARRIER Terminal Strips

Leakage path is increased—direct shorts from frayed terminal wires prevented by bakelite barriers placed between terminals. Binder head screws and terminals brass, nickel plated. Insulation, molded bakelite.



No. 2-142



No. 2-142-3/4 W

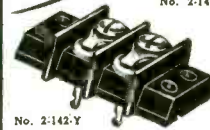

No. 2-142-Y

Shown: Screw Terminals—Screw and Solder Terminals—Screw Terminal above, Panel with Solder Terminal below. For every need.

Six series meet every requirement: No. 140, 5-40 screws; No. 141, 6-32 screws; No. 142, 8-32 screws; No. 150, 10-32 screws; No. 151, 12-32 screws; No. 152, 1/4-28 screws.

Catalog No. 21 lists complete line.



**HOWARD B. JONES DIVISION**  
CINCH MANUFACTURING CORPORATION  
CHICAGO 24, ILLINOIS  
SUBSIDIARY OF UNITED-CARR FASTENER CORP.

Want more information? Use post card on last page.  
CIRCLE 279 READERS SERVICE CARD

for Results



Mc GRAW-HILL  
DIRECT MAIL LIST SERVICE

McGraw-Hill Mailing Lists  
Will Help You

- Merchandise your advertising
- Conduct surveys
- Get inquiries and leads for your salesmen
- Pin-point geographical or functional groups
- Sell direct
- Build up weak territories
- Aid dealer relations

Direct Mail is a necessary supplement to a well rounded Business Paper advertising program.

Most progressive companies allocate a portion of their ad budgets to this second medium at the same time as they concentrate on the best business publications.

600,000 of the top buying influences in the fields covered by the McGraw-Hill publications make up our 150 mailing lists. Pick YOUR prospects out of our Industrial Direct Mail catalogue.

Write for your free copy.  
It contains complete information.

CO-AX

4 mmf/ft



★ **ULTRA LOW** capacitance & attenuation

WE ARE SPECIALLY ORGANIZED  
TO HANDLE DIRECT ORDERS OR  
ENQUIRIES FROM OVERSEAS  
**SPOT DELIVERIES FOR U.S.**  
BILLED IN DOLLARS—  
SETTLEMENT BY YOUR CHECK  
**CABLE OR AIRMAIL TODAY**



TYPE	μmf/ft	IMPED.Ω	O.D.
C1	7.3	150	.36
C11	6.3	173	.36
C2	6.3	171	.44
C22	5.5	184	.44
C3	5.4	197	.64
C33	4.8	220	.64
C4	4.6	229	1.03
C44	4.1	252	1.03

TRANSRADIO LTD. 138A Cromwell Rd. London SW7 ENGLAND CABLES: TRANSRAD, LONDON  
CIRCLE 280 READERS SERVICE CARD

for complete  
selection of Basic Requirements  
for your Coil Winding needs it's . . .

*Coil Winding Equipment Co.*

write for complete  
technical literature

COIL WINDING EQUIPMENT CO., Oyster Bay, New York

CIRCLE 282 READERS SERVICE CARD

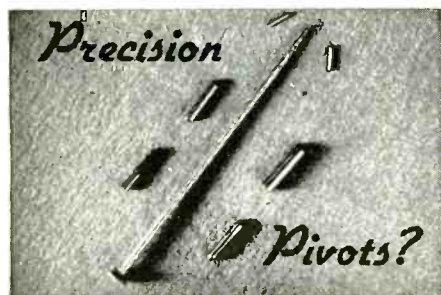

The "spike" in the center is a common pin.  
The others are VK precision pivots.

*Call VK*

Steel, chromium plated, or carbide  
precision pivots to .013" diameter.  
1 RMS or finer surface finish. Diam-  
eter tolerance to .000010". Chamfers,  
radii, lapped ends, etc.

Also volume production lapping of  
flat or round production parts.

Send us your specifications.

**The VAN KEUREN COMPANY**  
176-D WALTHAM ST. WATERTOWN, MASS.

CIRCLE 281 READERS SERVICE CARD

## New Books

### Television Engineering Handbook

EDITED BY DONALD G. FINK  
McGraw-Hill Book Co., Inc., New  
York, 1957, 1,483 p, \$18.00.

THE "Television Engineering Hand-  
book" is a monumental work which,  
in 20 chapters written by 33 au-  
thors, endeavors to present the  
factual information which one is  
usually looking for when he reaches  
for a handbook.

The opening chapters (written  
by the editor-in-chief in his usual  
lucid style) present basic equations,  
numerical data and constants, defi-  
nitions, explanation of technical  
terms and both Governmental and  
industrial standards pertaining to  
the radio frequencies, the video fre-  
quencies and (to a minor degree)  
the audio frequencies found in tele-  
vision. Furthermore, just about  
all the specialized fundamental data  
a television engineer is likely to  
need is also presented (common  
mathematical tables, which are  
generally available in other hand-  
books, are omitted).

► **Optical Aspects**—In the next  
two chapters, well-known authori-  
ties present, in satisfying detail,  
information relative to monochrome  
and color vision, geometric and  
physical optics and the colorimetry  
that is of interest to workers in the  
television field. The difference be-  
tween resolution as measured in  
photography and in television  
(which often confuses the uniniti-  
ated) is also detailed together with  
discussions of diffuse versus specu-  
lar densities, photographic film  
versus television camera speeds and  
(some 14 chapters later) the rela-  
tion between f/ and T-stop num-  
bers.

The theories of color vision and  
of color matching, which form the  
foundation for all color television  
systems are clearly presented, as  
are explanations of the foremost  
systems of color specification.  
Particular emphasis is placed upon  
the CIE system and its relation-  
ship to the NTSC color television  
system.

► **C-R Devices**—Following chap-

## ELECTRONIC ENGINEERS

don't get  
lost in  
the crowd!



We're growing every day at Electronic Engineering Company. But our growth is on a sound financial and organizational basis that assures your never getting lost — no matter how large we become.

If you're a qualified electronic engineer looking for the opportunity to gain recognition through significant achievement in the field of creative electronics, we invite you to join our staff.

*Your talents will never get lost here!*

Send a resume of your background to Bob Lander

Electronic Engineering Company  
of California



1601 EAST CHESTNUT STREET  
SANTA ANA • CALIFORNIA

## MEASUREMENTS' Standard SIGNAL GENERATORS

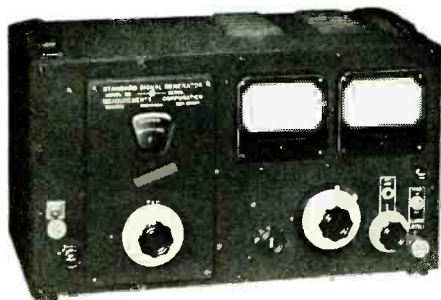

MODELS 80 AND 80-R 2 TO 475 Mc

### FEATURES:

- Completely self-contained.
- Direct reading scales and dials; individually calibrated.
- Convenient microvolt and DBM output scales.
- Accurate indication of output voltages at all times and at all levels.
- Low residual FM due to hum and noise.
- Provision for external pulse modulation.

Write for Bulletin

Laboratory Standards



**MEASUREMENTS**  
A McGraw-Edison Division  
**BOONTON, NEW JERSEY**

CIRCLE 283 READERS SERVICE CARD  
ELECTRONICS — December 1, 1957

NEW BOOKS

(continued)

ters cover cathode-ray devices, including both display and pickup tubes, and the scanning deflection circuits for monochrome and color picture tubes. A tabular summary of the important characteristics of six camera tubes currently in use (two of them abroad, only) for monochrome and color service in both television and industrial applications will be appreciated by those who have occasion to compare the characteristics of various pickup devices. Similarly, supplementing the descriptions and diagrams, there are summary tables comparing the principal monochrome and color picture tubes.

Another chapter covers the problems of scanning synchronization, synchronizing signal separation and makes passing mention of the decoding of color information synchronizing signal generation. The transmission of monochrome and color information and the nature of the composite video signals and waveforms that must be handled in such transmission are covered very competently and with thoroughness in still other chapters. The encoding of color signals is also covered in considerable detail.

Video frequency, radio-frequency and i-f system components are covered, as is the wideband modulation and demodulation processes and the numerous aspects of wave propagation in the vhf and uhf portions of the spectrum.

Two chapters are devoted to monochrome and color television receivers, one to television studio and film camera chains and still another to color broadcasting terminal equipment.

An authoritative chapter is devoted to the often forgotten, but very vital television relay systems and network transmission facilities that makes nationwide television possible in this country. Finally, television transmitters, and their associated transmission lines and antennas are described.

The bibliographies which accompany the various chapters vary from meagre to abundant. Where supplied, they will be valuable to workers in the field.

For the most part, the subjects are covered adequately. However,

Tensile  
anyone?



Somers

is  
game

If tensile strength of thin strip is a critical requirement of your present or anticipated production, Somers Brass will be glad to serve.

Nearly 50 years of experience with thin gauge brass, nickel, copper and alloys, plus complete laboratory facilities are available, without cost or obligation to you, to solve your problems in tensile strength, dimensions, temper and other properties.

Write for  
Confidential Data Blank.



Somers Brass Company, Inc.  
112 BALDWIN AVE. WATERBURY, CONN.

CIRCLE 284 READERS SERVICE CARD

## Pulse Notes



### Advantages of Air Gap vs. Toroidal Construction in Pulse Transformers

As pointed out in previous Pulse Notes, a pulse transformer wound on a core with an accurately controlled air gap performs more satisfactorily in some applications than one wound on a toroidal (gapless) core.

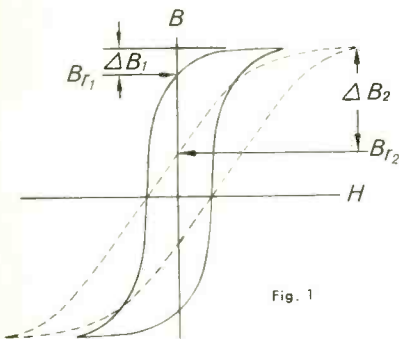

Fig. 1

Consider for a moment the two B-H loops in Figure 1. The loop shown in solid lines is for a toroidal sample of a typical magnetic material used in pulse transformers. The dashed loop is for the same material with an air gap included in the magnetic circuit. In the case of the toroid, removing the pulse magnetizing force causes the core flux to return to the value  $B_{r1}$ . On the next pulse the total flux swing possible is  $\Delta B_1$ .

The gapped core, on the other hand, returns to  $B_{r2}$  which allows the much greater flux swing  $\Delta B_2$ . Consideration of the voltage-time integral,  $ET = NA \int dB$ , indicates that a pulse transformer wound on the gapped core passes a pulse of greater area without core saturation than one wound on the gapless or toroidal core.

\*This discussion is valid only for cases in which no reverse (resetting) current flows in any of the transformer windings.

For further technical information including diagrams, specifications, and schematic applications of pulse transformers, write for your free copy of our new 12-page catalog.

## Pulse Engineering Inc.



2657 Spring Street  
REDWOOD CITY  
CALIFORNIA

CIRCLE 285 READERS SERVICE CARD

NEW BOOKS

(continued)

as is probably unavoidable in an undertaking involving as many authors as does this handbook, there is repetition, as well as gaps and, of course, differences in the clarity, completeness and up-to-dateness of the various chapters.

The index, although extensive, omits the listings of some important topics.

► **Audio**—In common with practically all books on television, (including one by this reviewer) only the absolute minimum of mention is made of the audio signal that is an essential part of a complete television signal. The preoccupation of transmitter and receiver design engineers, of some operating personnel, and even of program producers with obtaining an excellent picture, but with little regard to the sound quality, is truly amazing. Perhaps this book might better have been called a "Video Handbook."

This handbook is a must on the shelves of electronic libraries.—**HOWARD A. CHINN**, *CBS Television, Div. of Columbia Broadcasting System, Inc., N. Y., N. Y.*

### Introduction to Printed Circuits

BY ROBERT L. SWIGGETT  
*John F. Rider Pub., Inc., New York, 1957, 101 p., \$2.70.*

ALTHOUGH production engineers will find here no long-sought secret formulas for etching and plating solutions, no magic answers to dip-soldering problems and no completely new printed-circuit techniques, this little paper cover book does constitute an excellent means of becoming acquainted with the complete picture of printed-circuit developments for the past twenty years.

► **Major Emphasis**—Logically this book deals with the steps involved in converting copper-clad XXXP phenolic laminate into an assembled and soldered circuit, with a chapter on repair procedures thrown in for good measure. Automatic assembly systems are covered without going into the many problems which have beset purchasers

# Want HIGH

INSULATION AND  
MECHANICAL STRENGTH?

## get BOTH

## IN NATURAL MICA

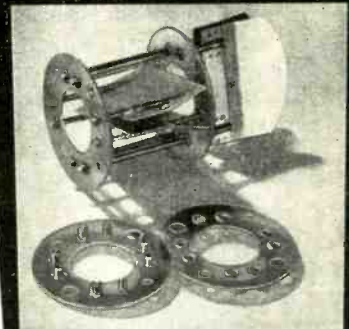

"Gun" assembly for oscillographic tube depends on .020" thick natural mica for insulation and structural rigidity.

Natural MICA's 6.2 Kv/mil dielectric strength and low thermal expansion answer a critical electronics need. High heat resistance and 32,000 psi *minimum* compressive strength are added values. *And*, mica can be readily fabricated to extremely close tolerances.

You get *all* of MICA insulation's advantages when FORD shapes and fabricates it into the precise forms you need. Write for MICA BULLETIN and details.

### YOUR PROBLEM ?

... Discuss it with FORD MICA engineers, backed by 40-year-plus leadership in mica insulation precision-stamping and fabrication.

Since  
1917

# FORD RADIO & MICA CORP.

536-540 63rd Street  
Brooklyn, N.Y. GEdney 9-8300

CIRCLE 286 READERS SERVICE CARD

December 1, 1957 — ELECTRONICS

**PRECISE  
CURRENT**  
for your  
**TESTING  
NEEDS!**

**VARIABLE FREQUENCY  
MOTOR GENERATOR SETS  
ADJUST 360 TO 440 CPS**  
Generator mounted controls include reset buttons, limit switch. Motor and generator remain stationary. Vari-drive pulley adjustment controlled by small motor. Remote control panels available.

NEW BOOKS

(continued)

of these multi-station machines. Plated circuits receive a more factual coverage, with an excellent discussion of adhesion problems. Lesser used techniques are covered adequately for the reader who seeks quick orientation.—J. M.

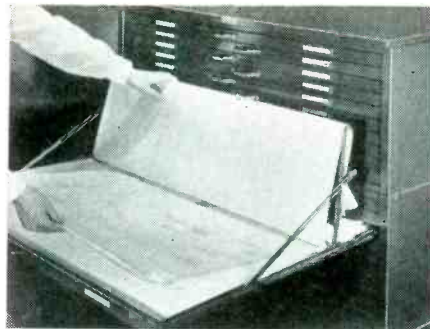

every tracing's a top tracing in a . . .

## Thumbnail Reviews

**Professional Engineers' Income and Salary Survey.** National Society of Professional Engineers, 2029 K St., N. W., Washington, D. C., 1957, 45 p., \$1.00 (paper). Results of 1956 survey of 17,000 registered professional engineers in all technical branches.

**Audio Amplifier Service Manual, Vol. 9.** Howard W. Sams & Co., Indianapolis, Ind., 1957, 240 p., \$3.95. Data on 15 amplifiers, three preamplifiers, 12 tuners and five custom radios produced during 1956.

**An Introduction to Reactor Physics, 2nd Edition.** D. J. Littler and J. F. Raffle, Pergamon Press Inc., New York, 1957. Based on a set of declassified lectures given by the authors to the Reactor School at the Atomic Energy Research Establishment in Harwell, the first part of this book deals with nuclear physics while the last part shows, in detail, the calculations used in evaluating the critical size of a gas-cooled, graphite moderated, natural uranium reactor.

**Marine Electrical Practice.** By G. O. Watson, Philosophical Library, New York, 1957, 325 p., \$12.00. This book will be primarily of interest to marine engineers who want to learn about the electrical equipment they must operate.

**Elements of Color in Professional Motion Pictures.** Society of Motion Picture and Television Engineers, New York, 1957, 104 p. Introduction to films, lighting, makeup, processing, printing and other aspects of production of professional color motion pictures.

**Ionization and Breakdown in Gases.** By F. Llewellyn-Jones, John Wiley & Sons, Inc., New York, 1957, 176 p., \$3.50. Fundamental principles of motions of electrons and ions in gases and physical processes which cause the phenomenon of the electric spark.

**Electric Hygrometers—NBS Circular 586.** By Arnold Wexler, U. S. Government Printing Office, Washington 25, D. C., 1957, 21 p., \$20 (paper). Various humidity sensors are classified and discussed in accordance with their basic principles of operation and the simple circuits that are used to measure the resistance of the sensors are presented. Advantages and disadvantages of the various sensors are also covered.

## Hamilton Shallow Drawer Unit

This remarkable, ten drawer file safely stores 1000 tracings, yet any one of them is instantly available.

There's a patented *tracing*

*lifter* in each file drawer. Just

raise the lifter,

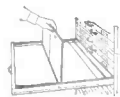

locate the desired drawing,

and fold back all the sheets

above it.

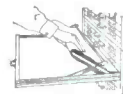

*The tracing you want is now on top*

—easy to slip out



and replace with no



danger of wrinkling or tearing.

Here's a fast and safe way to handle your valuable active tracings—and only Hamilton Shallow Drawer Units have it!

## Hamilton

DRAFTING EQUIPMENT

HAMILTON MANUFACTURING COMPANY

TWO RIVERS, WISCONSIN

CIRCLE 289 READERS SERVICE CARD



Units can be equipped with synchronous motor starter and magnetic amplifier, automatic voltage regulator.

**KATO 400 CYCLE  
MOTOR GENERATOR SETS  
NOW UP TO 250 KW!**

KATO MOTOR GENERATOR SETS are available in frequencies, speeds and sizes for every specialized use . . . operating high cycle tools, testing components and electronic equipment.



Input 60 Cycles  
Output 400 Cycles

WRITE FOR NEW FOLDER!

Builders of fine Electrical Machinery Since 1928

## KATO Engineering Company

105 MAXFIELD AVENUE, MANKATO, MINN.  
CIRCLE 287 READERS SERVICE CARD

"The Acton Laboratories 550A has . . .

**1/25 THE  
OPERATING  
COST . . . . .**

compared with . . . "



for complete details, ask for LABORATORY REPORT Vol. III No. 1



**ACTON LABORATORIES, INC.**  
ACTON, MASS.

CIRCLE 288 READERS SERVICE CARD  
ELECTRONICS — December 1, 1957

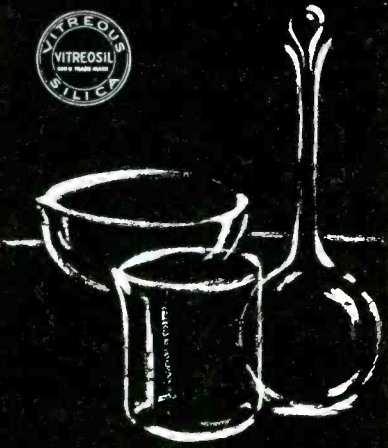

**Look no further—  
If you're looking for  
"HIGH PURITY"  
fused quartz**

**LABORATORY WARE**

The world's largest producer of fused quartz products can help you with your most critical and exacting needs for your laboratory ware.

Vitreosil® products can be supplied in an unusually large variety of types and sizes. Also fabricated to specification to meet semi-conductor requirements for the production of silicon metal.

**TRANSPARENT VITREOSIL**

For ultra-violet applications, metallurgical investigations, chemical research and analysis, photochemistry, spectroscopy and physical, optical and electrical research.

Send specifications for your requirements. Please use coupon below.

**THERMAL AMERICAN  
FUUSED QUARTZ CO., INC.**  
18-20 Salem Street, Dover, New Jersey

Please send technical data on \_\_\_\_\_

Company \_\_\_\_\_

Name & Title \_\_\_\_\_

Street \_\_\_\_\_

City \_\_\_\_\_ Zone \_\_\_\_\_ State \_\_\_\_\_

**Letters**

**An Oddity of Dots**

DEAR SIRs:

THE second paragraph (of "Core Tester Simplifies Ferro-Amplifier Design," by Roberts and Horstman, Aug. 1 p 150) says in part: "It [a core-test method] consists of using a half-wave rectified current to drive the core flux to saturation once each cycle. A d-c control current reset the flux during the off half-cycle. . . ."

While the description states that the d-c control current resets the flux, it is not certain whether it is in the same or in the opposite direction relative to the rectified saturating current. Normally, of course, the reset current is in the opposite direction.

If the dots are ignored in Fig. 5A,

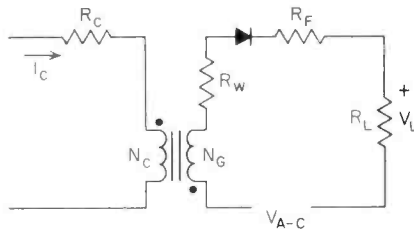

it could be assumed that the effects of the currents in  $N_c$  and  $N_g$  are opposite. In Fig. 6A, the + sign

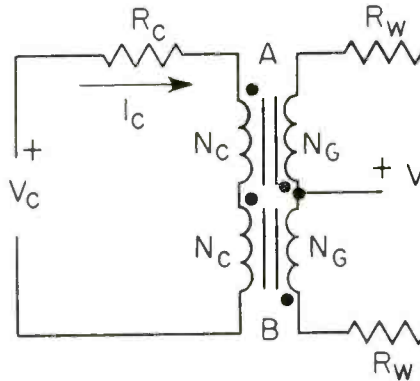

indicates that the arrow in Fig. 5A shows current direction. If the dot had the same meaning as the knot in a coil lead, indicating the start of a winding, where both windings were wound in the same manner, then the currents would have the same saturating effect on the core and there would be no reset.

Frankly, I think ELECTRONICS

**MODERN COIL  
EQUIPMENT**

*Plus*

**MODERN COIL  
HANDLING**

*Insure perfection in  
all DANO COILS*

- Encapsulated coils . . . in either polyester or epoxy resins.
- Coils for high temperature applications.
- Bobbins coils.
- Paper interleave coils.
- Cotton interweave coils.
- Form wound coils.

ALSO TRANSFORMERS MADE TO ORDER



CIRCLE 291 READERS SERVICE CARD

**NEW CHRISTIE**

**SILICON**

**POWER RECTIFIERS**

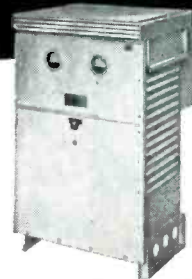

**For Top Reliability**

- A standard line from 30 to 1000 amps
- Closely regulated by magnetic control
- Voltages: 8-16-32-36
- Stationary or Mobile Types
- For Missile, Aircraft, Lab & Factory

Write for Latest Bulletins on  
Silicon & Selenium Power Rectifiers

**CHRISTIE ELECTRIC CORP.**

Dept. EL, 3410 W. 67th St., Los Angeles 43

Over a Quarter Century of  
Rectifier Manufacturing

CIRCLE 292 READERS SERVICE CARD

December 1, 1957 — ELECTRONICS

CIRCLE 290 READERS SERVICE CARD

### BRIGGS ASSOCIATES, INC.

*Engineering Services*

ELECTRONICS                      MECHANICAL  
Development — Manufacturing — Consulting  
Special Machines — Instrumentation — Automation  
Electron Tube Design, Materials, Reliability  
10 DeKalb St. Broadway 9-2120 Norristown, Pa.

# PROFESSIONAL SERVICES

### CROSBY LABORATORIES, INC.

*Murray G. Crosby & Staff*

Radio - Electronics  
Research Development & Manufacturing  
Communications, FM & TV  
Robbins Lane, Hicksville, N. Y.  
WE1s 1-3191

### McCann Engineering Company *Consulting Mechanical Engineer*

Design and Development of Test Equipment  
for Synchros, Potentiometers, Gyros, Etc.  
Redesign of Products—Trouble Shooting  
Production—Automatic Machinery  
Special Machines with Sequence, Form  
Recognition, Dimension Decision and  
Special Environment Features.  
9210 So. Vermont                      Los Angeles 44, Calif.

### ALBERT PREISMAN

*Consulting Engineer*

Television, Pulse Techniques, Video  
Amplifiers, Patent technical consultation.  
616 St. Andrews Lane, Silver Spring, Maryland

### DUNLAP ELECTRONICS, INC.

MANUFACTURING FACILITIES  
RESEARCH & DEVELOPMENT  
Specializing in Printed & Etched Circuits  
Transistors—Pulse Techniques—Environmental  
Test Facilities  
3 Day Service on Printed Circuit Samples  
764 Ninth Street                      Des Moines, Iowa  
AT 8-0801

### MEASUREMENTS CORPORATION

*Research & Manufacturing Engineers*

Harry W. Houck  
Specialist in the Design and  
Development of Electronic Test Instruments  
Boonton, New Jersey

### TELECHROME MFG. CORP.

*Electronic Design Specialists*

COLOR TELEVISION EQUIPMENT  
Flying Spot Scanners, Color Synthesizers, Keyers,  
Monitors, Oscilloscopes and Related Apparatus  
Telemetering for Guided Missiles.  
J. R. Popkin-Curman, Pres. & Dir. of Eng.  
28 Ranick Dr.                      Amityville, L. I., N. Y.

### ELECTRONIC RESEARCH ASSOCIATES, INC.

"TRANSISTORIZE" YOUR PRODUCT!  
Complete Service in consulting, research, develop-  
ment, and production on Transistor circuitry,  
products and instrumentation.  
67 Factory Place                      Cedar Grove, N. J.  
CENter 9-3000

### Eugene Mittelman, E. E., Ph. D.

*Consulting Engineer, Physicist*

INDUSTRIAL ELECTRONICS  
RESEARCH DEVELOPMENT  
Mathematical Analysis, Instrumentation & Control  
High Frequency Heating  
549 W. Washington Blvd., Chicago 6, Illinois  
Phone: STate 2-3171

### WHEELER LABORATORIES, INC.

Consultation—Research—Development  
Microwave—UHF—VHF—VLF  
Antennas and Components

Harold A. Wheeler and Engineering Staff  
HUNter 2-7876                      Great Neck, N. Y.  
Antenna Laboratory                      Smithtown, N. Y.

### ERCO RADIO LABORATORIES, INC.

*Radio Communications Equipment*

Engineering - Design - Development - Production  
Our 27th Year In Air to Ground  
Communication and Radio Beacons  
Garden City • Long Island • New York

### NIAGARA ELECTRON LABORATORIES

CONSULTATION - DESIGN - CONSTRUCTION  
MFG. THE THERMOCAP RELAY

Specializing in solution of problems of electronic  
and electro-physical instrumentation for the re-  
search or analytical laboratory. Industrial plant  
problems also invited.  
Andover, New York Cable Address: NITRONLAB

### YARDNEY LABORATORIES

*Research-Design-Development*

Electro-Chemical Generators of Energy  
40-18 Leonard Street                      WORTH 6-3100  
New York 13, N. Y.

## • CONTACTS •

FOR THE FIELD OF  
ELECTRONICS



## MANUFACTURERS' REPRESENTATIVES

IN THE ELECTRONIC INDUSTRY

As a service to readers, ELECTRONICS presents the advertisements for some of the leading manufacturers' representatives in the electronic industry. These firms are qualified to help the *Manufacturer* with his distribution problems; the *Buyer* with his product needs.

**RHEOSTATS  
RESISTORS**



**TOROIDAL  
CORE  
WINDING  
MACHINES**

**REX RHEOSTAT CO.**  
BALDWIN, N. Y.

### This CONTACTS Section

supplements other advertising in this issue with additional announcements of products essential to efficient and economical production and maintenance.

**HORMAN  
ASSOCIATES, INC.**  
2017 "S" STREET, N.W.  
WASHINGTON 9, D. C.  
DECATUR 2-5705

SERVING  
DELAWARE, MARYLAND  
DISTRICT OF COLUMBIA  
AND  
NORTHERN COUNTIES  
IN VIRGINIA AND WEST  
VIRGINIA  
TELETYPE NO. WA-559

REPRESENTING —

HEWETT-PACKARD CO.  
SORENSEN & COMPANY INC.  
VARIAN ASSOCIATES  
BETA ELECTRIC CORP.  
ELECTRO-MEASUREMENTS INC.  
GERTSCH PRODUCTS INC.

SENSITIVE RESEARCH INST. CORP.  
SANBORN COMPANY  
KINTEL (formerly KAY LAB)  
JOHN FLUKE MANUFACTURING CO.  
BUDD STANLEY COMPANY, INC.  
WEINSCHEL ENGINEERING CO.

Complete Recalibration Laboratory

# FM-AM STANDARD SIGNAL GENERATOR

## Type MS27

**FREQUENCY:**  
8.3—240 Mc/s in 5 ranges

**FM:**  
Normal:  $\pm 5$ ,  $\pm 25$ , and  $\pm 75$  kc/s ranges  
High:  $\pm 75$ ,  $\pm 150$ ,  $\pm 300$ , and  $\pm 600$  kc/s depending on frequency range

**AM:**  
0—80%

**DISTORTION:**  
< 2% at  $\pm$  kc/s FM  
< 5% at 50% AM



**O.TPUT:** 0.1  $\mu$ V to 0.1V across 50 or 75 ohms in 1 dB steps • Crvstal calibration of dial • Direct reading  $\pm 50$  kc/s Incremental Frequency dial • 50 and 75 ohms source impedances • Rugged militarized construction.

## RADIOMETER

72 Emdrupvej, Copenhagen NV-2, Denmark



Represented in Canada by

**BACH-SIMPSON** • London/Ontario

Represented in the United States by

**WELWYN INT. INC.** • 3355 Edgecliff Terrace, Cleveland 11, Ohio

CIRCLE 293 READERS SERVICE CARD

goofed, either in redrawing the figures incorrectly or in not noticing the oddity of the dots, or in being fallaciously convinced that all was well.

Is there any intention here of conforming to any convention, and what is the convention?

ALFRED P. STEENSEN  
46 Walnut Street  
Sharon, Massachusetts

DEAR SIRs:

MR. STEENSEN feels that the article is ambiguous in regard to the polarity of the d-c control current. To clarify this matter in his mind, I would like to say that the polarity dots are in full accord with accepted standards, and are also in accord with the definition outlined by Mr. Steensen.

However, the important point is that in terms of the conventions used in the article a positive control current is of the same polarity as the excitation current, and a negative value of control current is required to cause reset of the flux in the core. This is clearly indicated in Figs. 2 and 4 where an increase in the value of flux change is shown to occur for more negative values of control ampere-turns.

R. W. ROBERTS  
Magamp Engineering Section  
Westinghouse Electric Corp.  
Pittsburgh 30, Penna.

## Earn Extra Income in MOBILE-RADIO MAINTENANCE!



It's now a big business (650,000 installations) . . . fast-growing (70% increase just last year) . . . specialized . . . and high-paying!

Learn how to turn this opportunity into cash—write today for free booklet "HOW TO MAKE MONEY IN MOBILE-RADIO MAINTENANCE!" It's published as a service to radio engineers by Lampkin Laboratories, Inc., manufacturers of the well-known 105-B Micrometer Frequency Meter and 205-A FM Modulation Meter.

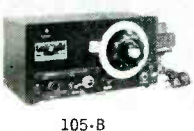

105-B



205-A

**LAMPKIN LABORATORIES, INC.**  
Instruments Div., Bradenton, Fla.

At no obligation to me please send "HOW TO MAKE MONEY IN MOBILE-RADIO MAINTENANCE."

Name \_\_\_\_\_  
Address \_\_\_\_\_  
City \_\_\_\_\_ State \_\_\_\_\_

CIRCLE 294 READERS SERVICE CARD

Precision drilling made easy!

## The Phillips & Hiss

204-D

6" Throat  
0 to 1/8" Capacity

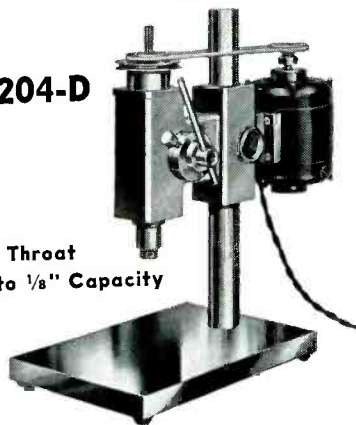

Sensitive "Feel"

**Sensitive Speed Control:** Foot operated, leaves both hands free.

**High Precision:** Spindle true within .0002". Table square .0001" per inch. Accuracy permanent, castings annealed and ground.

**Phillips & Hiss Company Inc.**

1145 No. McCadden Place  
Hollywood 38, California

CIRCLE 295 READERS SERVICE CARD

## Long Probe, Short Time

DEAR SIRs:

IT HAS come to my attention that there are several errors in the abstract "Long Scope Probes Using Passive Elements" (Sept. 1, p 206). The unit of time should be  $m\mu$ sec (millimicrosecond, 0.0001 microsecond) when referring to the rise times of the probe systems.

It should be mentioned that the probe rise-times of 16 and 14 millimicroseconds include an oscilloscope rise time of 12 millimicroseconds, so that the probes themselves have rise times of about 10.5  $m\mu$ sec for the 227-ft unit and 7.2  $m\mu$ sec for the 55-ft unit.

Also, Fig. 1A is not a "typical computer waveform," but merely a very fast and well-shaped voltage step used for testing and adjusting probe systems.

WILLIAM F. SANTELMANN JR.  
Lincoln Laboratory, MIT  
Lexington 73, Massachusetts

December 1, 1957 — ELECTRONICS



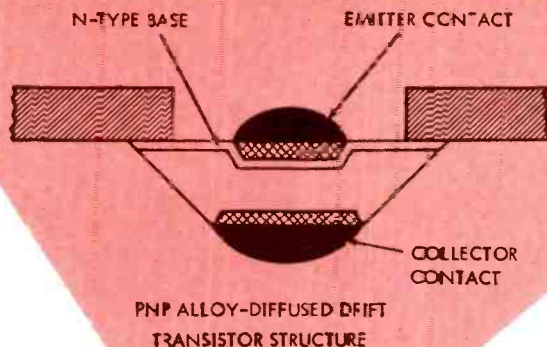

## Opportunities for Semi-Conductor Engineers at

# IBM

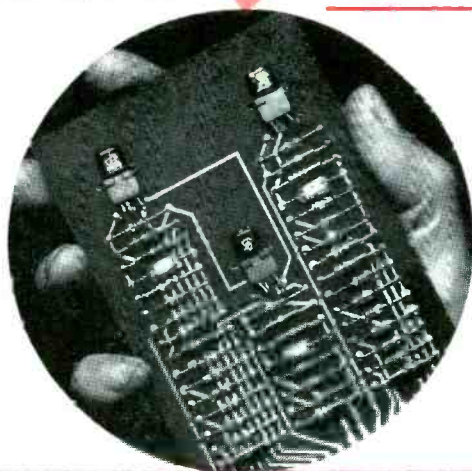

**Would you like to play a major role in the design, development, manufacture and application of transistors?**

IBM now has challenging assignments in the product development and application of semi-conductor devices for commercial data processing equipment. There are unlimited opportunities for professional achievement and advancement in our Laboratories at Endicott and Poughkeepsie, New York, and at our Manufacturing Facilities at Poughkeepsie, New York.

### Qualifications

**Advanced degree** in electrical, mechanical or chemical engineering, physics, metallurgy or chemistry, *and*

**At least 2 years' experience** in the design, development, manufacture or application of semi-conductor devices and materials.

**Additional career opportunities are available in the following fields:**

- Numerical analysis and programming
- Memory devices

**For details, just write, outlining background and interests, to:**

**Mr. R. A. Whitehorne, Dept. 554L  
Mgr. of Technical Recruitment  
International Business Machines Corp.  
590 Madison Ave., New York 22, N. Y.**

# IBM

**INTERNATIONAL  
BUSINESS MACHINES  
CORPORATION**

DATA PROCESSING  
ELECTRIC TYPEWRITERS  
MILITARY PRODUCTS  
SPECIAL ENGINEERING PRODUCTS  
SUPPLIES  
TIME EQUIPMENT

Plants and laboratories: Endicott, Kingston, Owego, Poughkeepsie, Yorktown, N. Y.; Lexington, Ky.; Rochester, Minn.; San Jose, Calif.



# TO THE **ONE MAN IN THREE**



OFFICIAL U. S. ARMY PHOTOGRAPH

**ARMY'S HAWK MISSILE**, recently revealed, destroys attackers flying at even the lowest altitudes and in the blind zone of conventional radars. Raytheon is prime contractor with complete systems responsibility for HAWK—and for the Navy's new air-to-air Sparrow III.

To the one man in three who will qualify as a Raytheon engineer:

our small, versatile project groups are staffed with extremely capable engineers. This policy pays off exceedingly well for energetic, imaginative men who are looking for individual recognition with the challenge of responsibility and ready opportunity for advancement.

Which of these interesting  
Situations with a Future  
is right for you?

As one of the world's fastest growing electronics companies with a record for history-making achievements, Raytheon is continually expanding. Interesting, rewarding openings for all types of engineers now exist in:

**COMMUNICATIONS (Commercial and Military)**—scatter, microwave relay, multiplex, mobile transistorized equipment.

**COUNTERMEASURES**—radar countermeasures equipment, advanced study projects.

**RADAR (Pulse and CW Systems)**— search, fire control, bombing, navigation, air traffic control, weather and commercial marine.

**MARINE EQUIPMENT**—submarine, ship, and airborne sonar, depth sounders, direction finders.

**GUIDED MISSILES**—prime contracts: Navy Sparrow III (air-to-air), Army Hawk (ground-to-air).

**MICROWAVE TUBES**—amplitrons, magnetrons, klystrons, traveling wave tubes, storage tubes.

**ELECTRON TUBES, SEMICONDUCTOR DEVICES, MAGNETIC COMPONENTS • MICROWAVE COOKING OVENS, ELECTRONIC INDUSTRIAL EQUIPMENT, ELECTRONIC MEDICAL EQUIPMENT**

Raytheon plants are ideally situated for delightful suburban living in New England, California and Tennessee.

*For the details you want*, please write to Leonard B. Landall, Raytheon Manufacturing Company, Waltham 54, Mass. There's no obligation and your inquiry is completely confidential.

**RAYTHEON MANUFACTURING COMPANY**  
WALTHAM 54, MASSACHUSETTS

Are you the  
**ONE MAN IN THREE?**

Excellence  
in Electronics



**MICROWAVE & POWER TUBE** engineers check operation of Raytheon microwave tubes in Air Force jet.

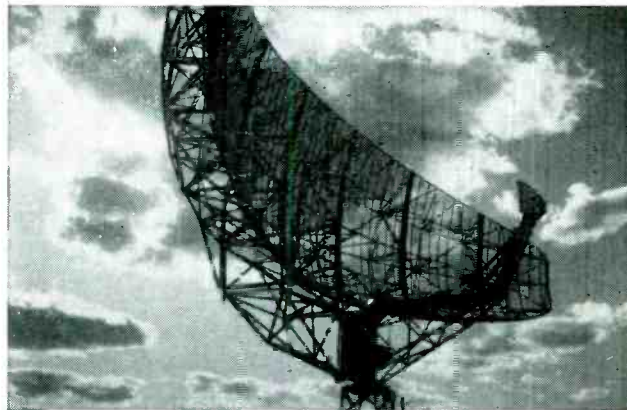

**WAYLAND LABORATORY** engineers developed this 40-foot L-band antenna to extend the range of radar.



**MAYNARD LABORATORY** engineers design and flight test airborne navigational and guidance systems.



**MISSILE SYSTEMS DIVISION** facilities include observation tower with radar tracking equipment.

ENGINEERS: *Electronic & Mechanical*  
Physicists

# MELPAR'S GROWTH CONTINUES

Healthy growth is steady and consistent, rather than explosive. Ours over the past 11 years has seen us double in size every 18 months. Today our 4000-man staff is engaged in 112 diversified electronic R & D projects, as well as weapons systems evaluation in several fields.

This continued expansion creates higher level openings for which you may compete strictly on the basis of your ability. At Melpar emphasis is placed on recognition of the individual and his creative contributions. You will enjoy a high degree of freedom to accomplish your assignments, and red tape and administrative detail are kept to a minimum.

Each of our three laboratories in the Washington, D. C., and Boston areas is well-equipped, geared to both present and future needs. Housing, recreational and cultural facilities available in both communities will make living gracious and enriching for you and your family.

Check your field of interest from the list below. Qualified candidates will be invited to visit Melpar as our guests.

Openings exist in these fields:

- Weapons Systems Evaluation
- UHF-VHF Circuit Design
- Servo-mechanisms
- Electronic Countermeasures
- Computer Programming
- Antenna Design
- Systems Analysis
- Digital and Analog Computers Design
- Transistor Circuits
- Microwave Component Design
- Radar and Fire Control Systems Design
- Microwave IF and RF
- Weapons Systems Evaluation
- Printed Circuit Techniques
- Digital and Analog Computer Techniques

FALLS CHURCH  
10 miles from  
Washington, D. C.

BOSTON

WATERTOWN  
Suburb of  
Boston

Write: Technical Personnel Representative



**MELPAR** Incorporated

A Subsidiary of Westinghouse Air Brake Co.

3425 Arlington Boulevard, Falls Church, Virginia

10 Miles From Washington, D. C.

# Follow the sun

## TO PHOENIX!

*...where Motorola offers rewarding opportunities!*

Work where it's fun to live. Advance your career—both in recognition and financial gain—at Motorola in Phoenix.

Your family will share your opportunity when you settle down in sunny, dry, healthful Phoenix! Tourists spend millions of dollars every year just to visit Phoenix. The attractions of this fabulous vacationland can be yours to enjoy year-round with Motorola!



If you are qualified for any of the positions below, write, wire or phone today.

**ELECTRONIC ENGINEERS,  
MECHANICAL ENGINEERS, PHYSICISTS**

- System Analysis, Design and Test
- Radar Communications
- Navigation Missile Guidance
- Data Processing and Display
- Circuit Design, Development and Packaging
- Microwave Digital and Analog
- R-F and I-F Transistor
- Pulse and Video Servos
- Technical and Specification Writing
- Printed and Etched Circuitry

Write:  
Mr. Kel Rowan  
Western Military Electronics Center  
Motorola, Inc., Dept. A-12  
8201 E. McDowell Road  
Phoenix, Arizona

Engineering positions also available at Motorola, Inc. in Chicago, Illinois, and Riverside, California.



**MOTOROLA, INC.**



# Towers of strength for America's defense

—Another challenge, another opportunity  
for Goodyear engineers

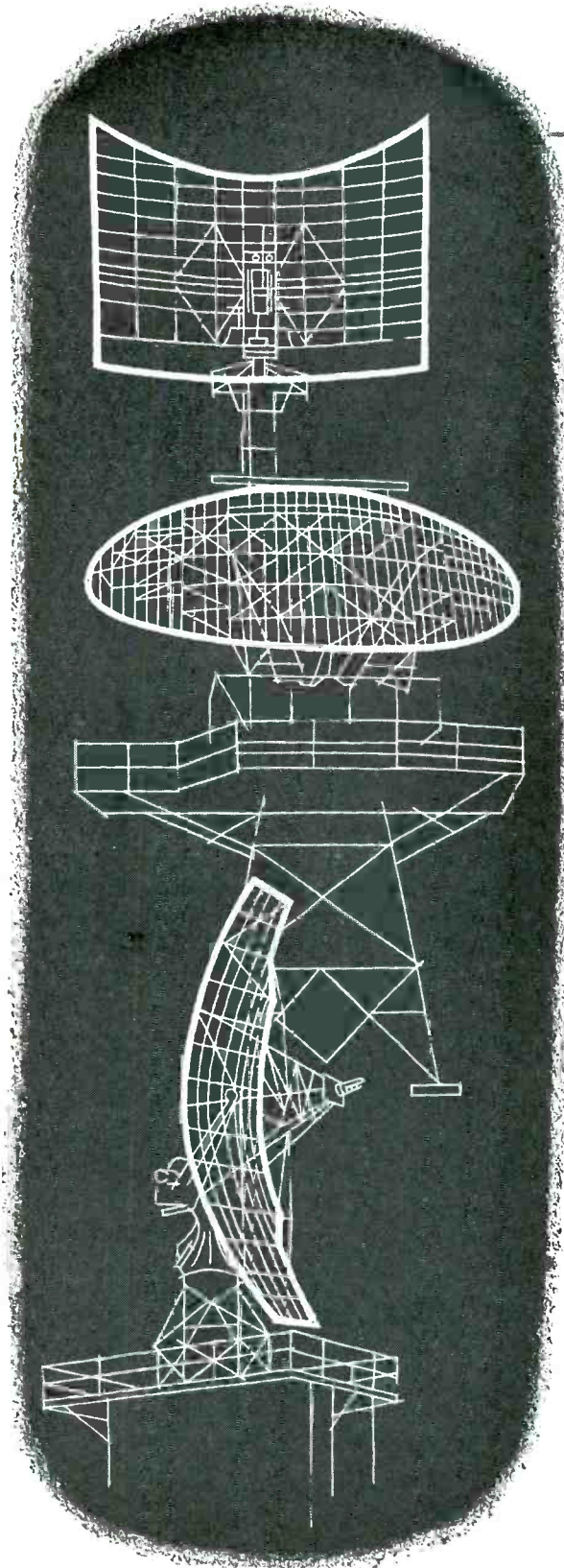

Wherever the American flag flies, you'll find radar structures like these—on 24-hour alert—ready to warn of an enemy's approach by air or sea.

Built by Goodyear Aircraft for the industry's leaders, radar structures require the utmost in engineering skill and training. They require a specialized knowledge as rare as it is vital. And they're typical of the opportunities that fire the imagination of our engineers at Goodyear Aircraft.

Here you'll find exciting challenges in airship design, electronics, missile components, metals engineering, radomes—the list is broad, the possibilities for achievement almost limitless.

At your disposal are the most modern engineering and research laboratories, including a large computer laboratory. And, needless to add, an environment in which individual expression can flourish, and ideas take wing.

Our continued growth and diversification have required expansion of our engineering staffs in all specialties at both Akron, Ohio, and Litchfield Park, Arizona. If you have faith in your ideas and in your ability to make them work, a rewarding career can be yours at Goodyear Aircraft.

Salaries and benefits are, of course, liberal. And if you wish to continue your academic studies, company-paid tuition courses leading to advanced degrees are available at nearby colleges.

For further information on your career opportunities at Goodyear Aircraft, write: Mr. C. G. Jones, Personnel Dept., Goodyear Aircraft Corporation, Akron 15, Ohio.

*They're doing big things at*

**GOODYEAR**  
**AIRCRAFT**





*Mathematicians use techniques of Operations Research to solve problems in weapon systems engineering*

## OPERATIONS RESEARCH

*... How It Solves Problems in  
Missile Countermeasures Research*

STAVID'S Operations Research group is now at work on one of the most urgent projects of all . . . defense against enemy missiles.

Some of America's foremost scientists are involved in the preliminary study phases of this project in which STAVID is playing a major role. The problems are challenging even to the most advanced theoreticians. STAVID offers growth opportunities as well as freedom of thought and action to top-level scientists, mathematicians and weapon systems engineers . . . in an unparalleled engineering atmosphere.

Our facilities and staff of over 250 engineers (representing one-quarter of the total employees) have been meticulously chosen for work in the fields of weapon systems, sophisticated radars, fire control, infra-red systems, passive detection and others.

*You are invited to send a complete resume to:*

J. R. Clovis, Technical Employment Representative, Dept. D400, Stavid Engineering, Inc., Plainfield, New Jersey, or ask for employment brochure describing STAVID and its opportunities.

### STAVID ENGINEERING INC.

ROUTE NO. 22  
PLAINFIELD, NEW JERSEY

## AN INVITATION TO JOIN ORO

*Pioneer In  
Operations Research*

Operations Research is a young science, earning recognition rapidly as a significant aid to decision-making. It employs the services of mathematicians, physicists, economists, engineers, political scientists, psychologists, and others working on teams to synthesize all phases of a problem.

At ORO, a civilian and non-governmental organization, you will become one of a team assigned to vital military problems in the area of tactics, strategy, logistics, weapons systems analysis and communications.

No other Operations Research organization has the broad experience of ORO. Founded in 1948 by Dr. Ellis A. Johnson, pioneer of U. S. Opsearch, ORO's research findings have influenced decision-making on the highest military levels.

ORO's professional atmosphere encourages those with initiative and imagination to broaden their scientific capabilities. For example, staff members are taught to "program" their own material for the Univac computer so that they can use its services at any time they so desire.

ORO starting salaries are competitive with those of industry and other private research organizations. Promotions are based solely on merit. The "fringe" benefits offered are ahead of those given by many companies.

The cultural and historical features which attract visitors to Washington, D. C. are but a short drive from the pleasant Chevy Chase suburb in which ORO is located. Attractive homes and apartments are within walking distance and readily available in all price ranges. Schools are excellent.

*For further information write:  
Professional Appointments*

### OPERATIONS RESEARCH OFFICE **ORO**

The Johns Hopkins University  
7100 CONNECTICUT AVENUE  
CHEVY CHASE, MARYLAND

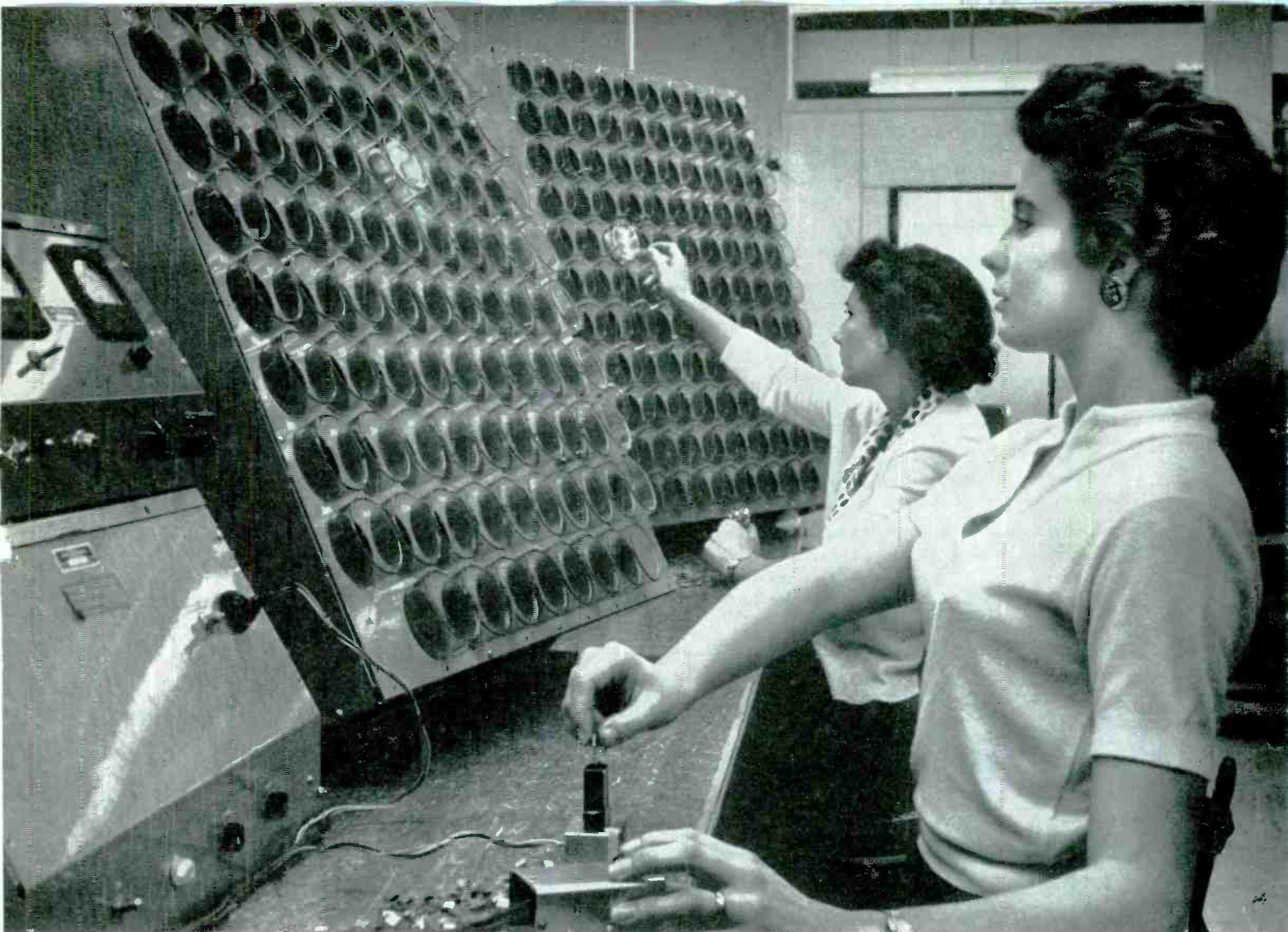

## lighting a transistor's way home . . . automatically!

Homely articles like water glasses and light bulbs are used in this automated selector built by TI mechanization engineers. Now, non-technical TI-ers close a circuit with a transistor just off the production line; wait a second for the circuit to evaluate it; then pop the unit into the glass that lights up. This "matching" operation is another advance toward automation of semiconductor manufacture . . . to free technical personnel for other important duties . . . to help Texas Instruments produce more electronic components and apparatus at lower cost.

This special application is typical of the many special engineering opportunities now open at Texas Instruments . . . openings for industrial engineers, machine designers, automation engineers, and other specialists to fill a continuing need to develop the mechanics for making things that have never been made before. Eighty per cent of today's TI products are new to its production lines within the last 3 years.

You are invited to join one of the many expanding programs at 27-year-old Texas Instruments . . . where recognition of individual achievement has contributed to TI's twentyfold growth in the last ten years — to a current

\$70 million volume. Advanced personnel policies include company-sponsored educational assistance, profit sharing, insurance, and retirement programs.

Texas Instruments plants are within Dallas, yet away from downtown traffic . . . within 5 minutes of fine residential areas, churches, and public and private schools. Your home will be within 15 minutes of year-around recreational, amusement and cultural activities.

**SEMICONDUCTORS AND OTHER COMPONENTS** — Design engineering, industrial engineering, production coordination, product evaluation, mechanization for making transistors, diodes, rectifiers, resistors, panel instruments. Write W. C. Spaller.

**ELECTRONICS AND ELECTROMECHANICAL APPARATUS** — Radar, sonar, infrared, navigation, magnetics, telemetering, communications, computers, transformers. Write R. E. Houston.

**RESEARCH** — Ph.D. level for research: semiconductor materials and devices, ferromagnetics, infrared, high speed data reduction, etc. **ADMINISTRATION** — Engineers for: production, planning, purchasing, cost analysis, etc. Write W. D. Coursey.

keep an eye on TI



**TEXAS INSTRUMENTS**  
INCORPORATED  
6000 LEMMON AVENUE DALLAS 9, TEXAS

# ENGINEERS

With a few years experience, for diversified assignments in design and development of electronic countermeasures.

Qualified and interested in research and study concepts on navigational guidance, radar, missile systems etc.

To engineers interested in opportunity to work at the top level of their skills, in a professional engineering atmosphere which encourages advanced thinking, Sanders has much to offer.

The favorable working and living environment is due to the engineering management which has led the company steadily forward since its organization 6 years ago . . . and to the location in the beautiful New Hampshire hill country just one hour from downtown Boston.

*Inquiries should be addressed to*

D. H. JOHNSON

 **SANDERS ASSOCIATES, INC.**  
95 CANAL ST., NASHUA, NEW HAMPSHIRE

## ENGINEERS & SCIENTISTS

Creative assignments are offered by Sylvania's Electronic Defense Laboratory in the San Francisco Bay area for work on electronic countermeasure systems & equipment. There are openings in the following fields:

- Systems Analysis
- Systems Synthesis
- Systems Test & Integration
- Research, Design & Development: Transmitters, receivers, components, antennas
- Equipment Engineering
- Field Engineering
- Mechanical Engineering

Sylvania is only 5 miles from Stanford University . . . and our liberal employee benefit program includes company assistance with tuition for advanced study. Salaries are commensurate with training and experience.

*To learn more about opportunities with Sylvania in California*

Please send your resume to J.C. Richards  
**ELECTRONIC DEFENSE LABORATORY**

 **SYLVANIA**   
SYLVANIA ELECTRIC PRODUCTS INC.

New  
Research  
and  
Development  
Opportunities  
in California  
as Sylvania  
Expands

Other Sylvania laboratories in Mountain View are:  
Microwave Physics Laboratory  
Microwave Tube Laboratory  
Reconnaissance Systems Laboratory

P.O. Box 1296  
Mountain View, California

**SPRAGUE**<sup>®</sup>  
the mark of reliability

## Permanent Employment Opportunities To Qualified Personnel

### • ELECTRICAL AND ELECTRONIC ENGINEERS

Work on Magnetic Devices for Computers. Location—Calif. and Mass.

Printed Circuit Development. Location—Massachusetts.

Complex Test Equipment Development. Location—Massachusetts

### • ELECTRICAL AND ELECTRONIC ENGINEERS

Application and Sales Engineering. Location—Massachusetts

### • ELECTRICAL AND CHEMICAL ENGINEERS

Electronic Component Research, Development and Design. Location—Mass. and N. H.

### • PHYSICAL CHEMISTS

Semi-Conductor Research. Location—Massachusetts

### • METALLURGISTS AND CERAMICISTS

Work on Electronic Materials. Location—Massachusetts.

*Please give full details of education and past employment Interviews will be arranged in East, Midwest, and California. You may write in full confidence to:*

**John Schimmel, Executive Engineer**  
**SPRAGUE ELECTRIC COMPANY**  
North Adams, Mass.



P  
H  
O  
N  
I  
X  
P  
H  
O  
N  
I  
X  
P  
H  
O  
N  
I  
X

At the crossroads of opportunity  
for men with vision in  
Electronic Engineering

## GOODYEAR AIRCRAFT CORPORATION

### ELECTRONIC LABORATORY

Arizona Division  
Litchfield Park, Arizona

A Subsidiary of the  
**GOODYEAR TIRE & RUBBER CO**

**WE HAVE OPENINGS  
IN OUR MODERN  
LABORATORIES FOR  
ADVANCED ENGINEERS  
IN ELECTRONIC RESEARCH**

Long range research and  
development projects

University of Arizona graduate  
studies available under company  
financed evening courses.

*Leisure Living At Its Best  
"In the Valley of the Sun"*

Modern Inexpensive Housing

Send resume to: A. E. Manning

Engineering and Scientific Personnel

## GOODYEAR AIRCRAFT

LITCHFIELD PARK  
PHOENIX, ARIZONA

Similar opportunities available in  
our  
Akron, Ohio Laboratory

**ENGINEERS • PHYSICISTS**

*Big things  
are happening*

in

**MOTOROLA's**  
Chicago Civilian Research  
and Development Laboratories

- Industrial Communications Equipment
- Consumer Products

Here is opportunity *unlimited* for men who like challenges and the rewards that go with accomplishment in non-military engineering assignments. This is your opportunity to advance your career while working in well instrumented laboratories and enjoying the benefits from association with men of the highest technical competence. There are many liberal employee benefits, including an attractive profit sharing plan.

You'll like living in one of the beautiful suburbs of the playground of the midwest, where there are endless social, cultural, and educational activities to choose from the year-round. Exciting life or quiet life—Chicago offers either.

Salary levels are open and commensurate with ability. Directly related engineering experience is *not* needed.

#### POSITIONS AVAILABLE IN:

- Two-way communications • Portable communications • Radio & TV (color)
- Component engineering • Transistor research and application • Microwave systems • Servo-mechanisms • Field engineering • Communications Sales Engineering • Field service engineering

For full discussion of these opportunities — Write:

Mr. L. B. Wrenn, Dept. A

MOTOROLA, INC.

4501 Augusta Blvd., Chicago 51, Ill.



# MOTOROLA

**PRODUCT ENGINEERS**

1. For design of production test equipment for electromechanical systems.
2. To supervise test equipment assembly and repair groups.

**PROJECT and FIELD ENGINEERS**

*Mechanical, Electrical, Physicist*

For engineering and development of advanced airborne navigation systems and related test equipment.

*Excellent opportunities with Kollsman, designers of America's finest aircraft instruments—a firm small enough to provide quick recognition, large enough to assure stability.*

Please send resumes to  
T. A. DeLuca



**kollsman** INSTRUMENT CORPORATION

80-08 45th AVENUE, ELMHURST, NEW YORK • SUBSIDIARY OF *Standard* COIL PRODUCTS CO. INC.

**FIELD SALES ENGINEER**

For established prestige line of precision electronic laboratory instruments in the New York to Washington, D. C. Area. Pioneer manufacturer (est. 1934), small company atmosphere and informality. Ideal country living—1 hour from N. Y. C.

Requirements: E.E. Degree, 3-5 years experience with electronic equipment. Sales aptitude or experience.

Please forward complete resume to:

**BOONTON RADIO CORPORATION**  
BOONTON, NEW JERSEY

**WANTED**

**Sales Representatives**

for selected national area coverage, by established manufacturer of servo devices and instruments.

**BW-6005, Electronics**

Class. Adv. Div., P.O. Box 12, N.Y. 36, N.Y.

**YOUNG ENGINEER**

Two or more years experience with electro-mechanical control devices and design. Bachelor of Science degree in Electrical Engineering from accredited college or university required. Salary open. Write personnel director.

**AUTOMATIC VOTING MACHINE CORPORATION**  
Jamestown, New York

**SENIOR RESEARCH PHYSICIST**

Two top openings for men experienced in electro-luminescence or magnetics. Ph.D. required. Excellent salary and working conditions. Write to D. Bellat, Personnel Director.

**TUNG-SOL ELECTRIC INC.**  
200 Bloomfield Avenue, Bloomfield, N. J.

**ENGINEERS**

If you have been looking for an Employment Agency that is skilled in the **STATE OF THE ART** of Technical Recruitment and **RELIABILITY OF INFORMATION** concerning positions, why not communicate with us at office! **ALL POSITIONS FEE PAID.**

**FIDELITY PERSONNEL SERVICE**  
1218 Chestnut St. Phila. 7, Pa.  
*Specialist in Aviation, Electronics and Nucleonics*

**RADAR**

**SECTION HEAD \$14,000 per year.**  
B.S. or M.S. or equivalent. Lead engineer, minimum 6 years experience. Must have ability to head up radar section for a new division. Company assumes all expenses. Contact us in strict confidence.

**MONARCH PERSONNEL**  
28 E. Jackson Blvd. Chicago 4, Illinois

REPLIES (Box No.): Address to office nearest you  
c/o This publication Classified Adv. Div.  
NEW YORK: P. O. Box 12 (36)  
CHICAGO: 520 N. Michigan Ave. (11)  
SAN FRANCISCO: 68 Post St. (4)

**POSITION VACANT**

**Electronic Circuit Design Engineers**—Several years experience and graduate training desirable (but not required) for challenging circuit design problems. Ability to work in small, outstanding group on varied high caliber design projects i.e. computer techniques application, data accumulation and reduction, pulse amplifier and discriminator design. Phillips Petroleum Company, Atomic Energy Division, P. O. Box 1259-BS, Idaho Falls, Idaho.

**POSITION WANTED**

**Mathematician-Engineer (29) M.A. Harvard.** 7 years experience in many practical phases of engineering and business. Probabilistic investigations in radar, digital computer programming including subroutines. Seeks variety of new problems. Will relocate and/or travel. PW-6647, Electronics.

**ELECTRONICS Magazine will become a weekly publication starting in January 1958.**

**ELECTRONICS is the magazine that locates the key buyers in the industry that are spending 6.9 billion dollars (at factory) in 1957 on electronic components and equipment.**

**ELECTRONICS readers during 1958 will number 52,000 important management people who make, use and buy electronic equipment.**

**S.E.E. GIVES To ENGINEERS**

Free Service in providing contacts for choice positions available now. Send resume.

**To EMPLOYERS**

Automatic access to a wide variety of desirable talent—now and regularly—from wide geographical locations.

Let us demonstrate immediate effectiveness.

**SCIENTISTS, ENGINEERS & EXECUTIVES, Inc.**  
1026 Seventeenth St., N.W.  
Washington 6, D. C. — METropolitan 8-2749

Electronic Engineers  
 Mechanical Engineers  
*Advancement... Security*  
*...Responsibility*

Professional personnel needed at all levels to fill responsible openings at this steadily expanding Division of Bendix Aviation Corporation. It's your chance to get specific assignments at the peak of the art in ELECTRONICS and MICRO-WAVE DEVELOPMENT and DESIGN. Good salaries, all employee benefits, ideal suburban living conditions. Whether you be a Department Chief or a Junior Engineer with less than one year's experience, we have the opening and the shoes for you to fill.

Address: Chief Engineer Dept. H



- Navigation Systems
- Communication Systems
- Servos
- Transistors
- Transmitters
- Receivers
- Antennas

**CAREER OPPORTUNITIES**

With a company making premium grade electronic equipment for aircraft for almost 30 years. Located in the beautiful lake region of Northern New Jersey, less than 35 miles from New York City.

- TRANSISTOR CIRCUIT PROJECT ENGINEER
- METHODS ENGINEERS
- GYRO DESIGN ENGINEER
- TECHNICAL WRITERS
- PRODUCTION ENGINEER
- CHIEF ENGINEER TO HEAD SERVO AND INSTRUMENT DEPARTMENT
- QUALITY CONTROL DEPARTMENT HEAD

Enjoy the pleasure of working in a new laboratory in a company whose products are known as the highest quality in the industry.

Write or call collect: Personnel Manager

**AIRCRAFT RADIO CORPORATION**

Boonton, N. J. DE 4-1800—Ext. 238

**DESIGN ENGINEER**

Mechanical—experienced product and tooling design, small precision components—hub Bronx, convenient transportation, benefits, salary open. Write resume, salary desired.

P-6590, Electronics  
 Class. Adv. Div., P.O. Box 12, N. Y. 36, N. Y.

**RATES** . . . . .

**"Employment Opportunities"**

*Displayed*—The advertising inch is \$26.83 per inch for all advertising appearing on other than a contract basis. Contract rates quoted on request.

An advertising inch is measured 7/8" vertically on a column—3 columns—30 inches to a page.

Subject to Agency Commission.

*Undisplayed*—\$2.40 per line, minimum 3 lines. To figure advance payment count 5 average words as a line.

Discount of 10% if full payment is made in advance for 4 consecutive insertions.

Not subject to Agency Commission.

Send NEW ADS to ELECTRONICS, Class. Adv. Div., P. O. Box 12, New York 36, N. Y., for January 3rd issue Closing December 2nd.

**CHIEF OF ELECTRONICS DESIGN**

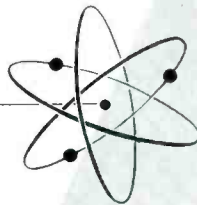

To manage electronics design for missiles and manned aircraft in Chance Vought's expanding Electronics Department of over 500 personnel. Candidate for this high-echelon position must be a creative, imaginative leader with a Doctor's degree in Engineering preferred, but at least an M.S. in Engineering backed up by 10 to 15 years of engineering experience.

Responsibilities will cover design activities in the fields of radar, radiation, servo-mechanisms, fire control, communications, support equipment, all types of guidance, reliability and product design.

Salary open. To inquire and negotiate in strict confidence, write direct to:

R. C. Blaylock, Vice-President,  
 Engineering, Dept. 5000-3



P. O. Box 5907 Dallas, Texas



**RADAR**

**P.P.I. REMOTE REPEATERS**

- VD 7" Upright
  - VE-7" Table Type
  - VF-5" "B" Scope "5" P.P.I.
  - VG-24" Plotting Table
  - VJ-12" Upright
  - VK-12" Upright
  - VL-12" Upright R.H.I. IND.
- All indicators are 110v 60 cyc.



**RDO & APR-4 SEARCH RECEIVERS**

The RDO is a very elaborate radar search receiver greatly improved over the APR-4. The set uses APR-4 tuning units, but is much more versatile, having input metering, D.B. output meter, automatic noise limiter and greater selectivity and sensitivity. The RDO is recommended when only the very best will do. Input 110/60 cycs.

**BC-342 BC-312**

1.5-18MC Communication Receivers. The BC-312 Operates From 12V D.C. The BC-342 From 110V 60 Cyc. These Sets Incorporate a Crystal Filter B.F.O. Antenna Tuner Etc. We Can Supply these Receivers in Large Quantities.

**SCR-536 HANDI-TALKIE**

3-6 MC Hand Held Trans-Rec. with range of approx. 1 mile. This set is comp. self contained, Inc. Batteries. We can supply these sets in large quantities tested.

**SHORAN**

**AN/APN-3-AN/CPN-2**

The AN/APN-3 and AN-CPN-2 are Precision distance measuring installations. This equipment operates on 225 mc. The range is 250 miles with an accuracy of 25 feet. This equipment is widely used by geologists companies for prospecting and mapping. Power input is 110v 400 cyc and 28v Dc.

# Radalab INC.

87-17 124th St., Richmond Hill 18, N. Y.  
Phone Virginia 9-8181-2-3

OVERSEAS CUSTOMERS CALL US DIRECTLY BY  
TELEX OVERSEAS TELETYPE TWX N.Y. 4-4361

**EE-94-95**

**CODE PRACTICE EQUIPMENT**

This is 20 and 40 man code practice set. This equipment is a complete setup for a school to teach Morse Code up to 400 WPM. The set consists of a recorder, turntable, switchboard, TG-34 keys, code keys, headset, clock, timer, wire record set, oscillator, etc. We can supply this set from a current production contract. Write.

**COUNTER MEASURES EQUIPMENT**

**SEARCH DETECTION**

- AN/APR-4 38-4000 MC RDO 38-4000 MC
- AN/APR-2 300 1000 MC SCR-616 145-600 MC
- AN/APR-5 1000-3100 MC
- AN/APR-6 1,001-10,000 MC

**DIRECTION FINDING**

- AN/APA-17 300-10,000 MC
- AN/APA-24 100-750 MC
- AN/APA-48 140-300 MC

**PANORAMIC AND PULSE ANALYZING**

- AN/APA-6 Pulse Analyzing
- AN/APA-11 Pulse Analyzing
- AN/APA-10 Panadapter
- AN/APA-38 Panadapter
- AN/ARQ-5 18-80 MC Receiver Indicator
- AN/ARQ-8 25-105 MC Barrage Rec-Trans Indicator
- AN/ARQ-10 1.5 MC-50 MC Receiver-Trans, Jammer Indicator
- AN/ARQ-1 Thru 12 also avail.
- AN/APA-23 Signal and Time Recorder

**NOISE GENERATORS**

- AN/URA-T1 AN/URA-2T MD-4/URA
- Shot-Noise, Bagpipes, Tone, Random Keying, Output. These units will key any transmitter.

**JAMMER TRANSMITTERS**

- AN/APT-1 thru 10 25-3,000 MC AN/APQ-15
  - AN/APQ-1 thru 20
  - AN/SPT-Series
  - SCR-596 1.5-30 MC Barrage Ground Jammer
  - T.D.Y. MRQ, SPT, SPQ-TPQ-1AN/UPT-T1-T3, T4
- Many other countermeasures equipments avail. both hi and low power. These equipments can be used to test new radar and computer systems for susceptibility to jamming and other countermeasures. We can supply complete setups covering any freq. from 100 KC 10,000 MC. with power supplies for mobile operation.

**MAR POINT TO POINT RADIO SET**

Portable 225-398 mc point to point 10 chan. crystal controlled voice and morse radio set. This is a very late radio set used for point to point and ground to air communication. The transmitter output is 8 watts on 10 pre-set crystal controlled channels instantly selected by a band switch. The REC is also crys. controlled on the trans. freq. The set is inclosed in 3 water proof shock proof cabinets that may be set up in a few minutes on location. This equipment is ideal where a reliable radio link easily transported is needed. Power Input is either 24 VDC 115/230V AC or DC. Complete sets avail. Write

**AN/PRC-6**

**47-55 MC HANDI-TALKIE**

This is the Standard MIL. F.M. Handi-Talkie With a Range of About 1 Mile. The Set Operates From Batteries With an Output of .25 Watts. The Set is Self Contained With Its Own Antenna. Weight is Approx. 6 Lbs. The Set is Crystal Controlled and Will operate with PRC, SCR 508, 608 SCR-300 Etc. Quantities Avail.

**AN/TRC-1-3-4**

**100 MC RADIO-RELAY EQUIPMENT**

The AN/TRC series is a mobile portable set for duplex or simplex radio telephone point to point communication. This set will operate with the CF series carrier systems to provide multi channel operation. The TRC operates on 100 MC with an output of 10-50 watts. The set is crystal controlled. Complete sets avail. Input 110v 60 cyc.

**SCR-399-499**

Mobile and fixed station high power radio sets: the SCR-399 is mounted in a HO-17 shelter. The SCR-499 is transported in carrying cases to be set up for field operation. Freq. of the sets is 2-18 mc. pwr output is 350w. Phone and C.W. 2 communication receivers are provided. Input is 110v 60 cycs.

**• RADALAB • RADALAB • RADALAB • RADALAB • RADALAB • RADALAB • RADALAB • RADALAB •**

## COMMUNICATIONS EQUIPMENT CO.

**X-BAND—RG, 52/U WAVE GUIDE**

- PARABOLOID DISH, 18" diam. Spun Aluminum 8" Focus. For AN/AP5-6 ..... \$4.50
- 3 CM DIPOLE and Feed Assembly (May be used with above dish.) 8 inches long. .... \$5.00
- FLEXIBLE SECTION 9 in. long. Cover-to-Cover \$5.50
- ROTARY JOINT (APS-8) Sperry PT #659275, 180 deg. rotation, choke to choke. Has "Built-in" Di-Coupler, 20 DB, with "N" Takeoff. .... \$17.50
- 30" Paraboloid Reflector Spun Aluminum dish 10 1/2" Focus ..... \$4.85
- 3 CM. DIPOLE FEED, 15" L. for APS-15 10 1/2" focus ..... \$12.50
- MITRED ELBOW, Cast aluminum, 1 1/4" x 9" W.C. W. E. Flanges, "E" Plane. .... \$3.50
- 3 CM. ANTENNA ASSEMBLY: Uses 17" paraboloid dish, operating from 24 vdc motor. Beam pattern: 5 deg. in both Azimuth and elevation. Sector Scan; over 180 deg. at 3000 rpm minute, Elevation Scan; over 2 deg. Tilt. Over 24 deg. .... \$35.00
- Cross-Guide Directional Coupler, UG-40 output flange. Main Guide is 6" Long, with 90 Deg. "E" Plane bend at one end, and is fitted with Std. UG 29/UG 40 flanges. Coupling figure: 20 db Nominal. .... \$22.50
- Bulkhead Feed-Thru Assembly ..... \$12.00
- Pressure Gauge Section with 1 1/2 in. gauge. .... \$10.00
- Directional Coupler, UG 46/U take off 20db. .... \$15.00
- MAGNET AND STABILIZER CAVITY For 2341 Magnetron ..... \$24.50
- 90 degree elbows, "E" Plane 2 1/2" radius. .... \$8.50
- Beacon/receiver unit. Complete with dual klystron mount, TR/ATR section, duplexer and 30 mc IF/Mixer unit. Originally designed for 9000 mc receiving using 723A/B. New, less tubes. .... \$22.50

**MICROWAVE MAGNETRONS**

- |       |         |      |         |       |         |
|-------|---------|------|---------|-------|---------|
| 2J21A | \$3.50  | 2J62 | \$4.75  | 706A  | \$14.50 |
| 2J22  | \$3.50  | 4J34 | \$32.50 | 706D  | \$14.75 |
| 2J27  | \$3.75  | 4J42 | \$22.50 | 706CY | \$9.75  |
| 2J31  | \$9.00  | 5J23 | \$18.00 | 706EY | \$9.75  |
| 2J32  | \$9.25  | 5J30 | \$4.75  | 725A  | \$2.90  |
| 2J33  | \$9.00  | 700M | \$8.75  | 730A  | \$4.75  |
| 2J39  | \$22.50 | 700D | \$8.75  |       |         |

**UNDERWATER MICROPHONE**

Model JR-1 Hydrophone is a piezo-electric device using an array of 20 barium titanate cylinders enclosed in a rubber cylinder 4 1/2 inches L and 2 1/2 inches in diam. Sensitivity: -105 db/microbar relative to 1 v/microbar. Frequency response: 200-15,000 cps. Impedance 100-150 ohms. The response at rt. angles to axis is uniform over an azimuth of 360 deg. The Hydrophone may be operated at depths up to 1000 ft. and temperatures of -1 deg. C. to 35 deg. C. .... \$52.50

**COAXIAL R.F. FILTERS**

- F-29/SPR-2, Hi-Pass, with 1000 mc. Cut-off. Type "N" input and output. 50 Ohms Z. .... \$9.50
- F-41/SPR-1, Hi-Pass, with 300 mc cut-off. Type "N" input and output. 50 Ohms Z. .... \$10.50

**I. F. AMPLIFIER STRIPS**

- Model 15: 30 Mc center frequency. Bandwidth 25 Mc gain figure: 65 db. Uses 5 stages of 6AG7's. Has D.C. Restorer and Video Detector. A.F.C. Strip included. Input impedance: 50 Ohms. Less tubes. .... \$17.50
- Model APS-4: Miniature IF strip, using 6AK5's 60 Mc center Freq. Gain: 95db at Bandwidth of 2.7 Mc. New, less tubes. .... \$15.50

**3000 MC WAVEMETER**

Mfd. by G. E. for Armed Services 3000-3700 MC. Comes furnished with variable attenuator, coax adapter cord. Cal. chart and pickup antenna. Has output jack for external meter or other monitor device. Reasonance indicator is 3/4" 20 microamp meter. Brand new, in portable wooden carrying case



\$75.00

**PULSE TRANSFORMERS**

- K-2745 Primary: 3.1/2.8 KV, 50 ohms Z. Secondary: 14/12.6 KV 1025 ohms Z. Pulse length: 0.25/1.0 usec @ 600/600 PPS. Pk Power 200/150 KW. Bidlar: 1.3 Amp. Has "built-in" magnetron well. .... \$32.50
- K-2461-A. Primary: 3.1/2.6 KV-50 ohms (line). Secondary 14/11.5 KV-1000 ohms Z. Pulse length: 1 usec @ 600 PPS. Pk. Power Out: 200/130 KW. Bidlar: 1.3 Amp. Fitted with magnetron well. .... \$29.50
- K35145 Pulse Inversion: PRI: 5 KV PK. Pulse Negative. Sec: Pos. Pulse, 4 KV; 1 usec. and .001 DUTY RATIO ..... \$6.50
- 541318-1-3 wdgs. Ratio: 1:1:1, 1.0 uh, /wdg. 2.5 ohms DCR ..... \$3.50
- UTAH X-151T-1: Dual Transformer, 2 Wdgs. per section 1:1 Ratio per sec 13 MH inductance 30 ohms DCR ..... \$5.00
- UTAH X-150T-1: Two sections, 3 Wdgs. per section, 1:1 Ratio, 3 MH, 6 ohms DCR per Wdg. .... \$5.00
- 686711: Ratio: 4:1 Pri. 200V, Sec. 53V, 1.0 usec Pulse @ 2000 PPS, 0.016 KV. .... \$4.50
- TR1049 Ratio 2:1 Pri. 220 MH, 50 Ohms, sec. 0.75 H. DCR 100 Ohms ..... \$6.75

**SPECIAL VALUES!!**

- Receiver front end cavity resonator: Tunes 2700 to 3400 mc with a loaded Q of 3000. 50-ohm, type N input. Video output from IN27 crystal. May be used at quarter wave (1.1 to 1.4 km). .... \$22.50
- 10 CM. ANTENNA ASSY. (Airborne), 30" dish with coax. dipole feed. Focal length is 10 1/2" Horiz. polarization, 350 deg. azimuth. Tilt: plus and minus 20 deg. 28 vdc drive motor, sealyn takeoff. .... \$65.00
- CRYSTAL OVEN, B liley #TCO 2B. Lactal base, with provision for 2 crystals, 6.3V heater 75 deg. Cent. .... \$2.50
- COAX. SWITCH, 4 pos. 52 ohms imp. Fitted with type N connectors. Useful up to 8,000 mc. .... \$17.50
- APT-4 Jamming transmitter. Uses 5J30 or 5J31 magnetron. Power output: 130 watts, 350-760 mc. New complete with tubes. .... \$115.00
- MD 30/APT-4. Modulator. For noise modulating of APT-4. Operates from 115v, 400 cy. New. .... \$45.00
- FILTER, Artificial Line: WECO D163169, 650 ohms imp. insertion loss: 5 db. .... \$32.50
- Barry shock mounts: nos. 2045, C-2060, C-2070, C-2090 ..... 45c ea.
- Trihedral radar reflector, MK-1, aluminum. .... \$3.50
- SPLICER, for 11/16 perforator tape, WECO #X-61859 list 20 SCS #4TW 61859-20. Complete set, with rubber tape dispenser. .... \$8.50
- MN 28Y Control box, unit of MN 26 compass. New. .... \$3.75
- Noise filters, Mallory NF-1, 100 amp/35vdc. .... \$1.00
- Power supply unit, navy-type-EJ-2, Input: 115 vac. 60 cy. Output: 135 vdc/10 ma. 90 vdc/5ma; 3 vdc/360 ma. New, complete with spare parts box. To be used with model TBX radio gear. .... \$9.50
- BC 602 Control box for SCR 522 (pushbutton). .... \$3.75
- 24-Volt Transformer. Input 115v/60 cy. Output 24 v/3A ..... \$1.75
- Phase-shifter, Helmholtz type 0-360 deg. .... \$2.50
- Capacitor, oil filled, 0.25 mfd, 25,000 volts dc. .... \$15
- Hydrophone, MODEL MI-2. A lattice of 3 crystals in a disk-like structure; 17-37 Kc. .... \$27.50
- AN/CRW-2A Remote control receiver, for operating target planes, etc. New, with soundproof mounting box. .... \$34.50
- TEL. REPEATER, EE 89, complete with tubes and tech. manual ..... \$17.50
- TEL. REPEATER, EE 99, with 12 vdc. vibrator power supply (PE 204) ..... \$49.50
- F.T.&R. 101-A. Two-wire applique, contains equalizing devices, and balancing circuit. Used for adapting 2-wire military circuits to 4-wire systems. .... \$47.50
- Butterfly tank unit; Tunes 60-300 mc. Ideal for frequency meter, grid-dipper, signal source, etc. New complete with acorn tube socket. .... \$5.75

**343 Canal St., New York 13, N.Y. Dept. E-12 Chas. Rosen Phone: Canal 6-4882**

# TUBES

- JAN and Commercial
- Advertised Brands Only!
- Special Prices To Quantity Buyers
- Guaranteed • Look & Compare
- From 10%-95% Below Manufacturers Prices

### RECEIVING TYPES

Write for Special Prices,  
Quantity Buyers

1A3	6SK7
1H5/GT	6W4/GT
2A3/G	6W6/GT
3A5	6Y6/G
6AB7	7A6
6AC7	7C4
6AC7W	7H7
6AK6	12A7
6AT6	12AX7
6BA/G	12C8
6C4	12SC7
6F5	12SH7
6J4	12SL7/GT
6J4WA	14N7
6J6W	25A V5/GT
6S67/GT	25BQ6/GT
6SH7	VR-105
	VR-150

### SPECIAL PURPOSE & TRANSMITTING TUBES

CEP-120	5.49	5D21	6.99	801A	4.22
CK-507AX	1.10	5D23	9.50	802	2.35
CK-521AX	1.10	7C22	49.95	803	2.00
EF-50	.59			806	3.75
				807	1.10
EM-3GA	39.50	10Y	.29	807W/5933	1.50
FP-62	2.95	15E	1.20	808	1.79
HF-100	7.49	35TG	3.25	814	2.49
HY-65	1.40	100TH	6.95	815	1.99
HY-114B	.59	100TL	10.95		
f123A	4.75	203A	2.50	826	.75
2C34/RK34	.29	204A	17.50	828	8.00
RK-59	1.88	205B	1.99	829B	8.50
RK-65/		207	39.95	830B	1.05
		211/VT4C	.49	836	1.20
		250TL	12.95	838	3.50
VR-78	.59	262B	5.00	841	.59
WE215A/VT-5		271A	12.99	843	.49
	6.25	276A	7.25	845	3.49
10Spec/VT-25A	.49	279A	7.50	851	6.49
45Spec/VT-52	.26	282A	3.75	852	15.00
		282B	7.50	860	3.49
		294A	8.00	864	14.00
30Spec/VT-67	.26			865	.69
		VT-127A	2.75	304TH	9.95
		VT-158	10.50	304TL	22.50
		ZB-120	.49	307A	.85
		1N40	4.50	310A	3.45
		1P30	1.35	316A	.59
		2B22	.49	328A	3.50
		2C26	.29	329A	3.25
		2C26	.29	350B	2.99
		2C39	4.00	HK354C	14.95
		2C39A	10.50	388A	1.49
		2C40	7.95	403B/5591	2.75
		2C42	8.49	414A	6.56
		2C43	8.00	446A	49
		2C44	1.35	446B	.99
		2C46	5.25	460	8.99
		2C51	2.75	464A	1.75
		2C53	9.90	483	8.95
		2E24	2.19	485	6.95
		2E27	9.95	585	9.95
		2E41	1.35	HY-615	.49
		2G22	2.29	701A	4.99
		3C28	5.95	703A	1.75
		3C33	5.99	708A	2.99
		3D23	4.99	713A	.96
		3E29	8.00	715A	2.00
		4C27	8.95	715C	6.49
		4D21	19.50	717A	14.50
		4E27	6.95	800	1.29
				8002R	18.50
				8005	4.50
				8012	1.85
				8025A	2.00
				8025A	2.25
				9001	.70
				9002	.50
				9003	1.25
				9004	.19
				9006	.19

### CATHODE RAY TUBES

2AP1	51.95	5HP4	2.49
2AP1A	5.44	5JP1	8.75
2BP11	7.99	5JP4	3.99
3AP1	2.50	5LP1	13.99
3AP11A	4.95	5JP5	5.95
3EP1	1.50	5RP2	12.95
3FP7	2.50	5NP1	1.99
3GP1	2.00	9LP7	9.00
3HP7	2.95	10KP7	12.95
5AP1	2.75	12DP7/A	
5BP1	2.45		
5BP4	2.75		18.95
5CP1	2.25	12GP7	12.95
5CP1A	12.45		
5CP11A	9.50	902P1	2.89
5FP7	2.50	902A	2.89

### THYRATRONS

2D21	5.79	3C23	3.75
2D21W	1.29	3C45	5.50
CSB	11.99	5C22	22.50
FG-105	1.99		
FG-154	9.95		
FG-172	13.45		8.50
FG-190	12.90	394A	2.99
KU610	2.45	884	1.00
2C33/RX233A	.69	885	1.10

### KLYSTRON

2K22	514.50	2K54	12.95
2K23	14.50	707A	2.55
2K25	14.75	707B	3.75
2K28	29.50	723/AB	7.99
2K33A	49.00	726A	4.50
2K35	99.50	726B	15.00
2K45	34.95	726C	12.50

### TR AND ATR TUBES

1B24	5.99	709A	1.69
1B26	1.00	721A	1.49
1B29	2.39	721B	7.00
1B32/		724A	1.15
532A	.99	724B	.89
471A	1.25	1960	1.89

### RECEIVING TUBES

1A3	.59	6A15	.49	6B4/G	.59	6J6W	.49	6Y6/G	.54
2A3/G	.69	6AN8	.89	6C4	.27	6J7/GT	.69	7A6	.44
2A7/G	.19	6AT6	.49	6C8/G	.36	6S67/GT	.32	7C4	.13
3D6	.24	6AV5/GT	1.15	6F5	.32	6SH7	.34	7H7	.38
3Q4	.64	6AV6	.49	6J4	1.40	6W4/GT	.61	12AX7	.64
6AG5	.49	6AW8	.95	6J4WA	2.45	6W6/GT	.74	12SC7	.31

ONE OF THE LARGEST SURPLUS DEALERS IN THE COUNTRY

## CONCORD RADIO CORP.

DEPT EI, 45 WARREN ST., N. Y. 7, N. Y.

Formerly FAY-BILL Distributing Co.

CAnal 6-8404

Digby 9-1132

All boxed and fully guaranteed. Special quantity discount—10% on 100 or more of same type. Minimum order \$10.00. Thousands of other types in stock. Send us your requirements. F.O.B. New York 25% deposit with order or if paid in advance save C.O.D. charges. Rated firms net 10 days. Prices subject to change without notice. For fast service ask for Sy.



ENGINEERING DEGREES IN E.E.  
Under & Postgraduate Major Electronics May be earned by HOME STUDY or residence work.  
(P.I.U. at present operating as a College of Engineering only.)  
5719-G Santa Monica Blvd.  
Hollywood 38, California

### MIDWEST CAPACITY

MANUFACTURER OF WELL KNOWN ELECTRICAL & ELECTRONIC PRODUCTS WITH AVAILABLE MIDWEST CAPACITY IN ENGINEERING & PRODUCTION INTERESTED IN NEW PRODUCT IDEAS FOR MILITARY OR COMMERCIAL MARKET  
BO-6586, Electronics  
520 N. Michigan Ave., Chicago 11, Ill.

**CASH PAID!** Sell your surplus electronic tubes. Want unused, clean transmitting, special purpose, receiving, TV types, magnetrons, klystrons, Broadcast, etc. Also want military & commercial lab test and communications gear. We swap too, for tubes or choice equipment. Send specific details in first letter. For a fair deal write, wire or telephone: WALKER 5-7000  
**Barry, 512 Broadway, New York 12, N. Y.**

### WANTED

ART-13/T47A Trans - R5/ARN-7 Radio Com-  
mitter \$175.00 pass \$75.00  
ART-13/T47 Transmitter BC-348 Rec'r. Unmod.  
ter \$125.00 Q & R Models \$50.00  
BC-788C Alt. \$100.00 ARC-1 Trans \$200.00  
ARC-3 Transceiver BC-312 Rec'r \$40.00  
Complete \$200.00 BC-342 Rec'r \$50.00  
Ship via Express, C.O.D. Subject to Inspection to H. Finnegan, 49 Washington Ave., Little Ferry, N. Y.

### WANTED TO BUY

#### ELECTRONIC MATERIEL

Tubes, revrs, xmtrs, test equipment, components, etc. Any kind, any quantity. Turn your dead stock into cash. Highest prices (or swaps) paid for contract terminations, surplus (military or comm'l.) inventories, etc. Send list & details to

#### METRO ELECTRONICS

172 WASHINGTON ST., NEW YORK 7, N. Y.  
(or call Mr. Dolin at Beekman 3-4245)

# SEARCHLIGHT SECTION

(Classified Advertising)

## RATES DISPLAYED

The advertising rate is \$24.75 per inch for all advertising appearing on other than a contract basis. Contract rates quoted on request. AN ADVERTISING INCH is measured 1/8 inch vertically on one column, 3 columns—30 inches—to a page.

EQUIPMENT WANTED or FOR SALE ADVERTISEMENTS acceptable only in Displayed Style.

## UNDISPLAYED

\$2.40 a line, minimum 3 lines. To figure advance payment count 5 average words as a line.

PROPOSALS, \$2.40 a line an insertion. BOX NUMBERS count as one line additional in undisplayed ads.

DISCOUNT of 10% if full payment is made in advance for four consecutive insertions of undisplayed ads (not including proposals).

# ELECTRONIC

WAR TERMINATION INVENTORIES

WRITE OR WIRE FOR INFORMATION ON OUR COMPLETE LINE OF SURPLUS ELECTRONIC COMPONENTS. ALL PRICES NET F.O.B. PASADENA, CALIFORNIA

# C&H SALES CO.

2176-E East Colorado St.  
Pasadena 8, California  
RYan 1-7393

## INVERTERS

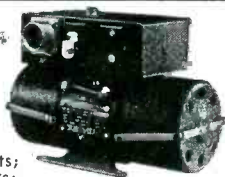

- 10042-1-A Bendix  
DC Input 14 volts;  
output: 115 volts;  
400 cycles, 1-phase; 50 watt **\$35.00**
- 12116-2-A Bendix  
Output: 115 VAC; 400 cyc; single phase; .45 amp. Input: 24 VDC, 5 amps. **\$35.00**
- 12117 Bendix  
Output: 6 volts; 400 cycles, 6 volt amperes, 1 phase. Input: 24 VDC, 1 amp. **\$15.00**
- 12121 Bendix  
Input: 24 volt D.C. 18 amp. 12000 r.p.m. Output: 115 volts, 400 cycle, 3-phase. 250 volt amp, 7 pf. **\$49.50**
- 12123 Bendix  
Output: 115 V; 3 phase; 400 cycle; amps. .5; Input: 24 VDC; 12 amp. **\$49.50**
- 12126-2-A Bendix  
Output: 26 volts; 3 phase; 400 cycle; 10 VA; 6 PF. Input: 27.5 volts DC; 1.25 amps. **\$24.50**
- 12130-3-B Bendix  
Output: 125.5 VAC; 1.5 amps. 400 cycles single phase, 141 VA. Input: 20-30 VDC. 18-12 amps. Voltage and frequency regulated. **\$49.50**
- 12137 Bendix  
Output 250 VA, 115 volts, 3 phase, 400 cycle, 1.25 amp., 0.8 pf. Input 27.5 volt DC, 20 amp. **\$59.50**
- 12142-1-A Bendix  
Output: 115 volts, 3 phase, 400 cycle, 250 VA. Input: 27.5 VDC, 22 amps. Voltage and frequency regulated. **\$99.50**
- 12147-1 Pioneer  
Output: 115 VAC, 400 cycles; single phase. Input: 24-30 VDC; 8 amps. **Price \$39.50 each**
- 778 Bendix  
Output: 115 volt, 400 cycle; 190 VA; single phase and 26 volt, 400 cycle, 60 VA, single phase. Input: 24 VDC. **\$37.50**
- 10285 Leland  
Output: 115 volts AC; 750 VA, 3 phase, 400 cycle, .90 pf and 26 volts. 50 VA single phase, 400 cycle, .40 pf. Input: 27.5 VDC 60 amps. cont. duty, 6000 rpm. Voltage and frequency regulated. **\$59.50**
- 10339 Leland  
Output: 115 volts; 190 VA; single phase; 400 cycle, .90 pf and 26 volts; 60 VA; 400 cycle, .40 pf. Input: 27.5 volts DC, 18 amps. cont. duty, voltage and freq. regulated. **\$49.50**
- 10486 Leland  
Output: 115 VAC; 400 cycles; 3-phase; 175 VA; .80 pf. Input: 27.5 DC; 12.5 amps.; cont. duty. **\$70.00**
- 10563 Leland  
Output: 115 VAC; 400 cycle; 3-phase; 115 VA; 75 pf. Input: 28.5 VAC; 12 amps. **\$35.00**
- F16 Jack & Heintz  
Output: 115 volts, 400 cycle, 1 or 3 phase, 250 VA pf. 9. Input: 27.5 volts, 20 amp. Electronic frequency and voltage regulated. **\$99.50 each**
- PE109 Leland  
Output: 115 VAC, 400 cyc.; single phase; 1.53 amp.; 8000 rpm. Input: 13.5 VDC; 29 amp. **\$50.00**
- PE218 Leland  
Output: 115 VAC; single phase pf. 90; 380/500 cycle; 1500 VA. Input: 25-28 VDC; 92 amps.; 8000 rmps.; Exc. Volts 27.5. **BRAND NEW \$30.00**
- MG149F Holtzer-Cabot  
Output: 26 VAC @ 250 VA; 115 V. @ 500 VA; single phase; 400 cycle. Input: 24 VDC @ 36 amps. **\$40.00**
- MG153 Holtzer-Cabot  
Input: 24 VDC; 52 amps. Output: 115 volts —400 cycles, 3-phase, 750 VA. Voltage and frequency regulated. **\$95.00**
- AN 3499 Eicor, Class "A"  
Input: 27.5 volts at 9.2 amps. AC. Output: 115 volts, 400 cycles; 3 phase, 100 voltamp; continuous duty. **Price \$39.50 each**

## PIONEER TORQUE UNITS



Type 12602-1-A. Includes CK 5 Servo motor coupled to output shaft thru 125:1 gear reduction train. Output shaft coupled to autosyn follow-up (AY-43). Ratio of output shaft to follow-up autosyn is 30:1. Includes base mounting type cover for motor and gear train. **\$19.95**

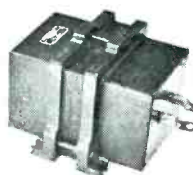

## S14940 TRANSFORMERS

Mfgd. by Kenyon. Output: 5 volts, 115 amps. Input: 105/125 volts, 60 cycle, single phase. Overall dimensions: 10" x 7" x 6". Approx. wt. 30 lbs. **\$15.00**

## SELSYNS-SYNCHROS



- ICT cnt. Trans. 90/55V 60 cy. **\$37.50**
- 1DG D ff. Gen. 90/90V 60 cy. **37.50**
- 1F Syn. Mtr. 115/90V 60 cy. **37.50**
- 1G Gen. 115V 60 cy. **37.50**
- 15F Syn. Mtr. 115/90V 400 cy. **12.50**
- 2J1F1 Gen. 115/57.5V 400 cy. **7.50**
- 2J1F3 Gen. 115/57.5V 400 cy. **10.00**
- 2J1FA1 Gen. 115/57.5V 400 cy. **7.50**
- 2J1G1 57.5/57.5V 400 cy. **5.00**
- 2J1H1 Diff. Gen. 57 5V 400 cy. **7.50**
- 2J1S1 Cont. Trans. 105/55V 60 cy. **17.50**
- 2J1S1 Cont. Trans. 105/55V 60 cy. **17.50**
- 2J1S1H1 Gen. 115/105V 60 cy. **17.50**
- 2J1S1M Gen. 115/57.5V 400 cy. **17.50**
- 5CT Cnt. Trans. 90/55V 60 cy. **34.50**
- 5D Diff. Mtr. 90/90V 60 cy. **34.50**
- 5DDG Diff. Gen. 90/90V 60 cy. **34.50**
- 5F Syn. Mtr. 115/90VAC 60 cy. **34.50**
- 5G Syn. Gen. 115/90VAC 60 cy. **34.50**
- 5HCT Cont. Trans. 90/55V 60 cy. **42.50**
- 5SDG Diff. Gen. 90/90V 400 cy. **12.50**
- 60G Diff. Gen. 90/90V 60 cy. **25.00**
- 6G Syn. Gen. 115/90VAC 60 cy. **34.50**
- 7G Syn. Gen. 115/90VAC 60 cy. **42.50**
- R110-24 Kearfott Cont. Mtr. 115V 400 cy. **17.50**
- R200-A Kearfott Cont. Trans. 26/11.8V 400 cy. **15.00**
- R210-1-A Kearfott Trans. 26/11 8V 400 cy. **20.00**
- R220-T-A Kearfott Receiver 26/11.8V 400 cy. **20.00**
- R235-1A Kearfott Resolver 26/11 8V 400 cy. **22.50**
- C56701 Type 11-4 Rep. 115V 60 cy. **20.00**
- C69405-2 Type 1-1 Transm. 115V 60 cy. **20.00**
- C69406 Syn. Transm. 115V 60 cy. **20.00**
- C69406-1 Type 11-2 Rep. 115V 60 cy. **20.00**
- C76166 Volt. Rec. 115V 60 cy. **10.00**
- C78248 Syn. Transm. 115V 60 cy. **12.50**
- C78249 Syn. Diff. 115V 60 cy. **5.00**
- C78863 Repeater 115V 60 cy. **7.50**
- C79331 Transm. Type 1-4 115V 60 cy. **20.00**
- 851 Bendix Autosyn Mtr. 22V 60 cy. **7.50**
- 403 Kellsman Autosyn. Mtr. 32V 60 cy. **7.50**
- FPE-25-11 Diehl Servo Mfr. 75/115V 60 cy. **19.50**
- FPE-43-1 Resolver 400 cy. **25.00**
- FJE-43-9 Resolver 115V 400 cy. **19.50**
- 999-0411 Kollsman 26V 400 cy. **15.00**
- 13770410 Kollsman 26V 400 cy. **10.00**
- 15158-0410 Kollsman 26V 400 cy. **20.00**
- 10047-2A Bendix 26V 400 cy. **12.50**
- 2900 Transicoil 115V 400 cy. **15.00**
- 15CX4a Synchro Transmitter MK 22 MOD 1 **15.00 ea.**

## INFRA RED SNOOPERSCOPE



High quality now at surplus prices. Eastman Kodak Infra-Red SNOOPERSCOPE Receiver, Type B, 7" long with 5" SCHMIDT ultra-high-speed Objective Lens (approx. f 0.5). Elaborate optical system, many coated lenses. Uses 2 penlight batteries. Govt. cost approx. \$300. Factory-new. Shipping wt. 9 lbs. Price **\$19.95** Waterproof Snooperscope Carrying Case, extra. Shipping wt. 3 lbs. Price **\$3.00**  
Dual purpose U.S.N. floodlight throws strong beam or invisible infra-red rays. With infra-red lens, spare sealed beam lamp, batteries. Shipping wt. 23 lbs. Price **\$14.95**

## DIFFERENTIAL



Size 2-11/16" long 1-11/16" dia. 1-1 reverse ratio. 1/4" shaft on each end; one shaft 25/32" long, one shaft 15/32" long. Input and output gear 1-23/32" dia. 53 teeth.

**\$3.50 ea.**

Stock No. 150

## SIMPLE DIFFERENTIAL

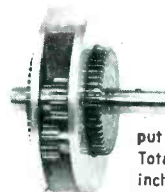

1 to 1 reverse ratio; 48 teeth on input and output gear, 1-1/32 inch diameter. Total outside diameter 1-25/32 inches. Shaft size is 1/4 inch. One shaft is 9/16" long; other shaft is 3/16" long. **\$5.00**

Stock No. 151

## BALL DISC INTEGRATOR

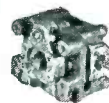

Forward & Reverse 2 1/4-0-2 1/4. Input shaft spline gear 12 teeth 9/32" dia. 3/8" long. Output shaft 15/64" dia. x 15/32" long. Control shaft 11/32" x 3/8" long. Cast aluminum construction. Approx. size 3" x 3" x 2 3/4". **No. 145 \$17.50 ea.**

(All Shafts on Both Ball Bearing Supported)

## SMALL DC MOTORS



- (approx. size overall 3 3/4" x 1 1/4" dia.)
- 5067126 Delco PM, 27 VDC, 125 RPM, Governor Controlled **\$15.00 ea.**
- 5069600 Delco PM 27.5 VDC 250 rpm **12.50**
- 5069230 Delco PM 27.5 VDC 145 rpm **15.00**
- 5068750 Delco 27.5 VDC 160 rpm w. brake **6.50**
- 5068571 Delco PM 27.5 VDC 10,000 rpm 1x1x2" **5.00**
- 5069790 Delco PM, 27 VDC, 100 RPM, Governor Controlled **15.00 ea.**
- 5BA10A118 GE 24 VDC 110 rpm **10.00**
- 5BA10AJ37 GE 27 VDC 250 rpm reversible **10.00**
- 5BA10AJ52 27 VDC 145 rpm reversible **12.50**
- 5BA10AJ50, G.E., 12 VDC, 140 R.P.M. **15.00**
- 206-1001 PM Planetary Gear Reduced, Motor with Magnetic Brake. Mfgd. by Air Equipment 26 volts 600 ma 145 rpm **17.50**
- 5BA10FJ33, G.E., 12 VDC, 56 R.P.M., reversible **15.00**
- 806069 Oster series reversible 1/50 h.p. 10,000 rpm. 27.5 VDC 1 5/8" x 3 1/2" **5.00**
- C-28P-1A 27 VDC 1/100 h.p. 7,000 rpm **3.00**
- 7100-B-PM Hansen 24 VDC 160 rpm **7.50**
- SSFD-6-1 Diehl PM 27.5 VDC 10,000 rpm **4.00**
- 6-volt PM motor mfgd. by Hansen 5,000 rpm 1 1/4" in dia., 2" long overall **4.00**

# SPECIAL OFFERING

## TUBES

	MOST ARE	JAN BOXED	ALL NEW	GUARANTEED	
20,000-VR150	27	100-5CP7A	4.00	1,000-865	.15
5,000-VR105	37	100-861	5.00	500-2E29	.50
15,000-OB2	42	200-851	5.00	1,000-7H7	.20
40,000-1U4	30	2,000-371B	5.00	1,000-7AG7	.50
40,000-6J4	40	2,000-828	35	500-6SN7WGT	.75
35,000-BAG	35	2,000-6107/BS212 Anton		500-REL36	.25
35,000-12AT7	55	Integrator	1.00	1,000-902P1	1.00
10,000-956	20	2,000-6108/BS213	1.00	10,000-954	.10
1,500-805	2.50	1,000-6109	1.00	10,000-955	.25
10,000-1625	20	2,000-26D6	.50	10,000-957	.25
40,000-1626	.05	1,500-958A	20	500-837	.80
10,000-1632	.05	5,000-6SG7GT	20	20,000-6SD7GT	.17
2,000-1960	20	40,000-6U7G	.10	100-5J26 Magnatron	150.00
2,000-5678	.50	10,000-6J7G	.15	orig case	750.00
1,500-5654/6AK5W	1.30	10,000-6K7G	.15	5-QK264 Magnatron	1.50
1,000-5841	1.25	5,000-VT67 (30 Special)	.10	5,000-807W/5933	1.00
500-CK1026	1.25	5,000-VT25 (10 Special)	.15	10,000-807	1.00
400-533AX	1.25	2,000-2C34	.15	5,000-1629	.60
750-5829WA	2.00	10,000-LN23 Diorle	.15	10,000-872A	.10
200-5896	2.50	1,000-WL1B32/532	.15	10,000-9006	.75
100-5647	2.50	800-6J4WA	1.00	1,500-6AC7W	6.95
1,000-5977	2.00	100-2C43	7.00	100 Beta Gamma Tube	
500-5AP1	3.00	2,000-RK73	.20	BS6	
1,500-5CP1	3.00	1,000-843	.16		

### Geiger Counters Radiation Detector

300 type WK10A list \$119.50	Special Price \$29.95
300 type WF11A list \$139.50	Special Price 31.95
200 type WF12A list \$149.50	Special Price 39.95
50 type WF16A list \$750.00	Special Price 149.50

Individually boxed, fully guaranteed

Mfg by largest Mfg in world

4,000 Johnson midget APC variable cond. with shafts, max. cap. 7.5 mmf . . . . . 30¢

1,000 Johnson 866A Socket—net 3.00 . . . . . Spec. \$1.00

500 Johnson 829B Socket #122/101—250 . . . . . \$1.00

1,000 Cinch 829B Socket—2.50 . . . . . 75¢

5,000 Claire telephone type relays many choices of contacts . . . . . 35¢

2,000 2 mfd-600V Upright oil cond. por. ins. . . . . 35¢

10,000 2 mfd-600V BATHTUB DYR TYPE SIDE TER—oil COND. 35¢

5,000 4 mfd-600V UPRIGHT OIL COND. . . . . 45¢

1,000 8 mfd-600V UPRIGHT OIL COND. . . . . 90¢

3,000 10 mfd-600V UPRIGHT #25F339 ceramic ins. oil cond. . . . \$1.05

1,000 1 mfd-2000V UPRIGHT OIL COND. . . . . 35¢

2,000 2 mfd-2000V UPRIGHT OIL COND. . . . . 75¢

3,000 Hammerlund Variable Condenser—Transmitting Type, 23 plate, 100 mmfd-v/w BC375, 2,500 volts ins. ceramic . . . . . \$1.25

1,000 Wallace Tiernan torsional relay, frequency selective for use in application where radio waves are control medium, unique principles used permit this relay to be used for most exacting conditions. Reg. price \$30.00 . . . . . SPECIAL WHILE THEY LAST \$2.95

Silver Ceramic Trimmers—Jobber Boxed—Types TS2A 1½-4½mmf, 3-13, 4-30, 7-45, have 20,000 of each . . . . . 15¢

1,000 Leach relays 115 VAC DTST 30 AMP, #6104 . . . . . \$4.00

1,000 Meters 2½ round 0 to 5 mills ind. boxed, black scale full def. \$2.50

Volume controls—have over 1,000,000 in stock

25,000 wirt, 2 watt W.W. 300 ohms, ¼"x¾" shaft . . . . . \$100 per M

5,000 500Ω, 1,000Ω, 2,000Ω, 5,000Ω, 10k, 15k, 20k, 50k . . . . \$100 per M

50,000 Mallory 2 watt W.W. 10,000 ohms, ¼"x¾" shaft \$100 per M

50,000 CRL ½ watt carbon, 1 meg screwdriver shaft . . . . \$50 per M

Write us for prices on your needs—save money

10,000 ea. APC Condensers, screwdriver shaft

25 mmfd—15¢ 50 mmfd 20¢ in 100 lots

Electrolytic Condensers—Plug in aluminum cans for octal sockets, size approx. 1½"x4"

50,000 35x35 mfd 350v . . . . . \$150 per M

40,000 2,000 mfd 15v . . . . . \$200 per M

Have 2,000,000 ceramic tubular cond.—sizes from 5 mmf, 10, 15, 25, 50, 56, 80, 100, 150, 200, 300, 500, 680, 750, 820, 950, 1000 . . . \$10 per M

Have 1,000,000 mica cond, postage type, 10% tol., sizes from 5 mmf, 10, 20, 30, 50, 80, 100, 150, 200, 300, 400, 500, 600, 800, 900, 1,000

\$15.00 per M

Have 1,000,000 micas, 10% tol. .0015 mmf, .002, .003, .004, .005, .006, .007, .008, .009, .01 . . . . . \$30.00 per M

1,500 American type TS13 Hanoset telephone phenolic case trans, receive switch in center of cradle arm—50 ohm transmitter 2000 ohm receiver, 68 inch cord with two phone plugs—American . . . . \$3.50

**DISCOPHONE SALES CO, Inc**  
35 Vestry Street, New York 13, N. Y. WOrth 6-0512

Wire Or Call Collect—Samples On Request

# AN/CRD-6

Ready for delivery! This rare equipment—and our low price—cannot be duplicated anywhere!

This is the famous UHF Radio Direction Finder and Homing Device. Frequency range: 225-400 MC. Also can be operated by remote control. Spare parts available.

### MT-686/GR RACKS

Available in quantity. Above equipment applicable to AN/GRR-7, AN/GRT-3, AN/GRC-27.

Call or write now for all data!

## ALVARADIO INDUSTRIES

Established 1947

Mailing Address:

P.O. Box 151-E, No. Hollywood, Calif.

Office-Warehouse:

5523 Satsuma Ave., No. Hollywood, Calif.

SALE! SALE!

### AN-130 ANTENNAS

BRAND NEW \$1.00

TALLEN COMPANY INC.

159 Carlton Ave., Brooklyn 5, N. Y.

TRiangle 5-8241 - 2

your dependable source for:

power  
rocket  
broadcast  
klystrons  
ignitrons  
magnetrons  
thyratrons  
ruggedized  
transmitting  
subminiatures  
special purpose  
photomultipliers  
transistors

requests for quotations  
immediately dispatched

transitube inc.

specialists in electronic  
tubes and transistors

114 liberty street  
new york 6, n. y.  
worth 4-0252





CONSISTENTLY HIGH QUALITY ELECTRON TUBES TRANSMITTING AND SPECIAL PURPOSE TUBES

Only Standard TOP QUALITY, or name tubes shipped. ALL PERFECT and GUARANTEED. At Sensible Prices!

Table listing various electronic tubes such as 6X4, 6X5, 6X6, etc., with their respective prices and technical specifications.

BARRY ELECTRONICS CORP. 512 BROADWAY N.Y. 12, N.Y.

Walker 5-7000 TERMS: 25% Deposit with Order. Balance C.O.D. - or Send Full Remittance with Order. Well Rated (D&B) Firms. Net 10. All Items Subject to Stock Depletion and Price Variation Without Prior Notice. All Merchandise Fully Guaranteed for Cost of Merchandise Only. Minimum Order \$10.00.

KOILED CORDS 3 wires \$726 22 inches long stretches to 9 ft.

Only a few more left GONIOMETER TYPE CFT-47372 - 250 to 1500 K.C.

nightlighter - Automatic light switch. Darkness throws the switch - turns lights on at dusk ... off at dawn. Pools burglars who watch for signs of an empty house. Same as your city buys for \$45 on top of street lamp posts. \$1595

TELECHRON Motors 1 RPM ... \$3.95 3.6 RPM ... \$3.15 2 RPM ... 2.90 60 RPM ... 4.85 3 RPM ... 3.90 3 RPM ... 2.85 4 RPM ... 3.90 1 RP 12HR. ... 3.25 1 RPM - 50 Cycles, \$1.85 Laboratory Special I of Each Motor \$25

PLEASE INCLUDE POSTAGE 64 V Dey St. New York 7

D-E-L-A-Y-E-D LIGHT SWITCH A-C-T-I-O-N Shuts light off automatically almost a minute later. Keeps porch or garage light on after you shut it off. \$3.50 DEALERS WRITE FOR PRICES.

6 Watt Mast POWERFUL TELECHRON MOTOR 110 V, 60 Cy I RPM ... 6.50

HAYDON TIMING MOTORS 1 RPM 110v 60cy ... 2.60 1 RPM 230v 60cy ... 1.00 2 RPM 230v 60cy ... 1.00 3 RPM 110v 60cy ... 2.60 450 RPM, yes 450 RPM HANSEN Synchron 4 RPM ... 4.24 CRAMER 4 RPM ... 4.65

RELAY CONTACT BURNISHERS .59 - 2 for \$1.00 DIEHL or DELCO P. M. motors. Made for 24 volts. Will work at lower speed at 12v. or 6v Battery \$375 or Rectifier. Size 1" x 1" x 2"

CAPACITORS SEE Oct. & Nov. Issues MONMOUTH RADIO LABS Box 159 Capital 2-0121 Oakhurst, N. J. Art Hankins, Owner

New Advertisements received by December 2nd will appear in the January 3rd issue, subject to space limitations. Classified Advertising Division Electronics P.O. Box 12 New York 36, N. Y.



# Universal RELAY CORP.

## THE LARGEST STOCK OF RELAYS IN THE WORLD

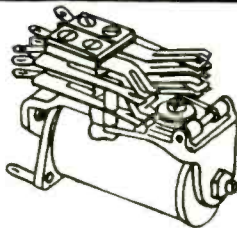

### SMALL TELEPHONE TYPE RELAYS

Similar in design and operation to the longer telephone types but approximately half the size. All connection are at one end. Clare type "J", Automatic Electric type "E", and Phillips 8QA are included in this group. Except for slow acting groups they can be mounted in any position. Coils and frames are standard and interchangeable.

#### COILS

For Cost of Relay Add Price of Coil to Price of Frame

Stk#	Ohms	Ea*
K801	100	1.25
K802	150	1.25
K803	300	1.25
K804	400	1.25
K805	500	1.25
K806	550	1.50
K807	1300	1.50
K808	2000	2.00
K809	4000	2.25
K810	6500	2.75
K811	20000	4.50
K812	21000	4.50

#### DUAL COILS

K813	380/380	2.00
K814	5000/10000	3.75

#### SLOW MAKE

Copper Slug at Armature End

Stk#	Ohms	Price Ea*
K815	24	2.00
K816	350	2.00

#### SLOW RELEASE

Copper Slug at Heel End

K817	350	2.00
------	-----	------

#### FRAMES

For Cost of Relay Add Price of Frame to Price of Coil

Stk#	Contacts	Price Ea*
F801	1A	1.45
F802	1A, 1B	1.65
F803	1A, 1C	1.85
F804	1A, 1B, 1C	2.00
F805	1A, 1B, 2C	2.50
F806	2A	1.65

Stk#	Contacts	Price Ea*
F807	2A, 1B	1.85
F808	2A, 1C	2.00
F809	3A	1.85
F810	3A, 1C	2.25
F811	4A	2.00
F812	4A, 1B	2.25
F813	4A, 2B°	2.50
F814	5A	2.25
F815	6A, 2C	3.50
F816	1C	1.65
F817	2C	2.00
F818	3C	2.50
F819	4C	3.00
F820	5C	3.50
F821	6C°	4.00
F822	Frame†	1.25

° Counterweight † No Contacts  
Send for latest Circular.

ALL MERCHANDISE IS GUARANTEED AND MAY BE RETURNED FOR FULL CREDIT

Prices listed with asterisk (\*) are subject to QUANTITY DISCOUNTS

1-9 ..... as quoted  
10-49 ..... 10%  
50-99 ..... 15%  
over 100 ..... 20%

## Universal RELAY CORP.

Formerly Universal General Corp.

42 WHITE ST., NEW YORK 13, N. Y. • WALKER 5-9642

## NEW YORK TUBE & TEST EQUIPMENT EXCHANGE

### NEW TS-147 X SIGNAL GENERATOR

Test Set TS 147 UP is a portable Microwave Signal Generator designed for testing and adjusting beacon equipment and radar systems which operate within the frequency range of 8500 MC to 9600 MC.

### NEW UNUSED SURPLUS TS 259 K BAND 23400-24500 MEGACYCLES SIGNAL GENERATOR

### New Unused Surplus Standard Laboratory Receivers

AN/APR4 complete with five tuning units  
38 to 4000 m.c.

AN/APR-5, 3000-6000 m.c. — AN/APR10, 2000-4400 m.c.

#### OTHER TEST EQUIPMENT USED CHECKED OUT SURPLUS

TSK1/SE	TS34/AP	TS100	TS182	TF890/1
TS3A/AP	TS35/AP	TS102A/AP	TS186	APA10
RF4/AP	TS36/AP	TS108	TS226	APA38
TS12/AP	I-96A	TS110/AP	TS239C	AP53 APS4
TA13/AP	TS-45	TS117	TS251	APT2-APTS
TS14/AP	TS46	TS125/AP	TS258	BC152C
TS15	TS47/APR	TS126/AP	TS259	BC788C
TS16	TS61	TS173	TS270	and many others
TS27	TS62	TS174/AP	TS419	
TS33/AP	TS69/AP	TS175/AP	TS497B	

#### SPECIAL

Thousands of tubes available at special prices  
PARTIAL LIST

2AP1	6H6	307A	5691
4C27	6K8G	274A	5692
4C28	6AR6	274B	5693
5A6	5R4WGY	262B	5639
5BP4	5W4GT	328A	5814
4J52	OZ4A	357A	9001
2A4G	6AC7	450TH	9002
6CZ1	28D7	450TL	9003
6J5GT	VT52	957	9006
89	MANY OTHER TYPES		

WHOLESALE and EXPORT ONLY  
Minimum tube order \$25



Phone: ORegon 4-7070

**LIBERTY ELECTRONICS, INC.**

119 PRINCE ST.  
NEW YORK 12, N. Y.

Cable: TELESERUP



#### WE BUY

ARC-3  
ARN-6  
ART-13  
AS-313  
LOOPS  
BC-788C

#### TEST EQUIPMENT

Top Prices Paid  
Write today!

Now available . . .

## NEW FREE SALES CATALOG 116

It is loaded with bargains in ALL departments:

Tubes

Meters

Headsets

Receivers

Transformers

Test Equip.

Mikes

Transmitters

Capacitors

Etc., etc., etc.,

SEND FOR CATALOG 116 TODAY!

You'll be glad you did!

## ARROW SALES, INC. Dept. E.

7460 Varna Ave., No. Hollywood, Cal.

## SYNCHROS

## TUBES

## LAB TEST EQUIPMENT

## SERVO MOTORS

ALL COMPONENTS FIRST QUALITY AND 100% GUARANTEED

IMMEDIATE DELIVERY FROM STOCK

Circle 360 Readers Service Card for 16 page catalog

## LECTRONIC

### RESEARCH LABORATORIES

715-19 Arch St., Phila. 6, Pa. • MARKET 7-6771

Cable Address: LECTRONIC, Philadelphia

## GLASS TUBING

PYREX - NONEX - URANIUM

BULB & CYLINDERS

WRITE FOR FREE MONTHLY LIST

HOUE SUPPLY COMPANY

PHONE KEYPORT 7-1286

M. R. #1 Box 86X

Keyport, N. J.

3x.2mf 4000vDCw \$2.15	2x.5mf 600vDCw 40¢
3x.5mf 600vDCw 50¢	Knob-dial 2 inch 9¢
.001mf 5000vDCw \$1.15	N750L 100mmf 7¢
2.5&10mf 400vDCw 95¢	110v to 14v 3A \$1.85
2x6.3v@1A 2x5v@7A 7.5v@24A 115v pri. \$7.45	shock mounts 3 lb 11¢ Send for List.
COOPER ELECTRICAL CO., Park Ridge, N. J.	

## A-B Brand

## RESISTORS any types—any values

FROM OUR OWN SHELVES

"KING OF THE RESISTORS"

Phone: YONKERS 9-6000

## LEGRI S CO.

YONKERS 5, N. Y.

# RELIABLE TUBES

C1B/A	\$9.50	3KP1	\$8.00	KU23	\$20.00	726C	\$15.00	5703WA	\$3.75	5931	\$4.75	6201	\$3.25
1B60	18.00	4-65A	22.00	V45	500.00	813	8.75	RK5721	150.00	5937	30.00	6214	40.00
1P40	2.25	4-1000A	95.00	V57	190.00	829B	8.50	5725	2.50	5949	100.00	RK6229	300.00
1P41	1.25	4D32	27.50	83V	1.00	832A	6.00	5744WA	4.00	RK5976	52.50	RK6230	375.00
2C39A	11.00	4J52	60.00	QK103	50.00	833A	27.50	5749	1.35	5981	65.00	6282	15.00
2J36A	90.00	4X150A	25.00	152TL	30.00	869B	20.00	5750	2.50	RK5982	200.00	6291	55.00
2J51	175.00	4X250B	45.00	FG172	20.00	872A	3.50	5751WA	3.75	6012	5.50	6326	275.00
2J51A	225.00	4X500A	95.00	QK181	50.00	873	19.00	5764	40.00	6029	2.25	6346	60.00
2J56A	90.00	5AQP1	30.00	QK185	75.00	CK1026	2.25	5768	30.00	6032	75.00	6347	80.00
2K25	20.00	5C22	25.00	QK202	200.00	R1111	3.50	RK5777	150.00	6037	125.00	6365	52.50
2K26	45.00	5FP14	10.00	QK247	175.00	5527	90.00	5784WA	4.50	6101	4.00	6383	75.00
2K28	30.00	5J26	250.00	250TH	22.50	5550	35.00	5787	3.50	6115	70.00	6414	5.50
2K40	90.00	5TP4	45.00	QK278	150.00	5563	30.00	5814A	1.50	6115A	85.00	6587	45.00
2K41	100.00	6AJ5	1.35	EE300	25.00	5593	175.00	5814WA	3.50	6116	135.00	6588	20.00
2K45	40.00	6BL6	28.00	304TH	22.50	5607	475.00	5817	150.00	6152	6.75	6655	45.00
2K48	60.00	6BM6	35.00	304TL	32.50	5626	25.00	5819	30.00	6161	55.00	6816	50.00
2K55	10.00	6BM6A	45.00	339A	5.00	5647	5.00	5829WA	2.50	6167	35.00	8000	10.00
2K56	50.00	6D21	135.00	QK351	70.00	5654	1.75	5854	1.50	6177	125.00	8003	10.00
3AP1A	12.00	6L6GA	1.75	QK404	50.00	5670WA	4.00	5865	110.00	6186	3.00	8005	5.00
3D22	12.50	6X5WGT	1.75	GL672A	25.00	5687	2.50	5876	8.50	6189	3.00	8014A	65.00
3E22	8.00	8D21	850.00	725A	35.00	5702WA	4.00	5902	5.00				

ALL mdse guaranteed. 24-hour telephones take your orders any time for prompt servicing. Material subject to prior sale.

## PAGE ELECTRONICS

136 Liberty Street

COrrlandt 7-4245

New York 6, N. Y.

### SEARCHLIGHT Equipment Spotting Service

This service is aimed at helping you, the reader of "SEARCHLIGHT", to locate Surplus new and used electronic equipment and components not currently advertised. (This service is for USER-BUYERS only). No charge or obligation.

How to use: Check the dealer ads to see if what you want is not currently advertised. If not, send us the specifications of the equipment and/or components wanted on the coupon below, or on your own company letterhead to:

Searchlight Equipment Spotting Service

c/o ELECTRONICS,  
330 W. 42nd St. N. Y. 36, N. Y.

Your requirements will be brought promptly to the attention of the equipment dealers advertising in this section. You will receive replies directly from them.

Searchlight Equipment  
Spotting Service

c/o ELECTRONICS  
330 W. 42nd St., N. Y. 36, N. Y.

Please help us locate the following equipment components:

.....  
 .....  
 .....  
 NAME .....

TITLE .....

COMPANY .....

STREET .....

CITY .....

12/1/57

BRAND NEW — TOP QUALITY — FULLY GUARANTEED

### CENTRIFUGAL BLOWERS

FOR VENTILATION, AIR SUPPLY, HEAT FLUSHING



100 C.F.M.—3" DIA. ROTOR  
 ROTOR: 3" x 2"  
 HOUSING: Steel. 4" dia. discharge flange. 3" inlet, 2" outlet.  
 MOTOR: AC, 60 cyc, 115 volt, 3000 rpm enclosed, continuous duty. OVERALL: 6 x 6 x 6 No. BL 100 HS \$895



275 C.F.M.—5 1/4" DIA. ROTOR  
 ROTOR: 5 1/4" x 3"  
 HOUSING: Steel. 4 3/4" sq. discharge flange. 5 1/4" inlet, 3 1/2" sq. outlet. MOTOR: AC, 60 cyc, 115 volt, 1550 rpm. Continuous duty. OVERALL: 8 1/2 x 8 1/2 x 7 No. BL 275-R-5 \$1495

45 C.F.M.—WITH AC/DC MOTOR.  
 ROTOR: 2" x 1". HOUSING: Plastic, 1 3/4" inlet, 1 1/8" outlet. MOTOR: Oster, 115 volt, AC-60 cyc/DC, 7200 rpm, ball bearing, enclosed. OVERALL: 3 1/2 x 3 1/2 x 5 \$2250

ILG — 63 C.F.M. — AC/DC  
 ROTOR: 2 3/4" x 1 1/2". HOUSING: Steel. 4" dia. outlet flange. 2 3/4" inlet, 2" outlet. MOTOR: ILG, 115 volt, AC-60 cyc/DC, 3400 rpm. Enclosed. OVERALL: 6 x 6 x 5 1/2 No. BLI-65D \$1550



TWIN BLOWER — 190 C.F.M. — 3 3/4" x 2" ROTORS  
 3 3/8" inlet; 2 1/8" outlet. Continuous duty motor. AC, 115 volt, 60 cyc., 1500 rpm. Overall — 7 x 6 x 9, No. BL 190-2R \$1295

ORDER NOW — WHILE STOCKS LAST — PROMPT SHIPMENT

ELECTRIC TRADING CO. Dept. E-10, 313-315 Canal St., New York 13, N. Y.

### COMMUNICATIONS EQUIPMENT & TEST EQUIPMENT

SEND US YOUR LIST OF REQUIREMENTS  
 ALL THE BEST & FINEST AT LOW PRICES

Also Maintenance Manual AN/ARC-27 1953 Revision  
 MAIL, WIRE OR TELEPHONE FOR QUOTE

MONTGOMERY EQUIPMENT CO.

14315 BESSEMER ST.

VAN NUYS, CALIFORNIA

TEL: State 6-4657

Telegraph YHV Van Nuys

#### TIME DELAY RELAYS

Miniature 7 pin plug in Delays from 1/2 to 10 seconds. Voltages from 2 to 115V. AC or DC. \$1.50

#### CRYSTAL CAN MAGNETIC RELAYS

DPDT Coils to 5000 Ohms. Contacts 2 Ends.

#### MAGNA ELECTRONICS CORP.

15 Rockland Terrace Verona, N. J.

#### WAVEGUIDE

RG-48-U 14 ft. lengths \$25.00 per length  
 Crating extra in less than 4 lengths  
 FOB New Orleans

#### FREELAND PRODUCTS CO.

706 Dryades St. New Orleans 12, La.

#### a TERRIFIC BARGAIN in a

#### SOLA CONSTANT-VOLTAGE TRANSFORMER

Ends fluctuating line voltage!



#### Big Discount Off . . .

the factory price at a 1-input 2,000 VA unit! And here's another bonus! This Air Forces 2,000 VA overstock, Sola Cat. No. 30768, has 4 inputs: 90-125 V., 190-250 V., 60 cy. or 50 cy. Isolated secondary is constant 115.0 V. ±1% from no-load to full-load of 17.8 amp. 5a. if you choose, use it as a 220-115 V. step-down. And slash \$97.50 off the factory 1-input price!

Brand new in original wood box. 4 cu. ft. Ship. wt. 234 lbs. F.O.B. Pasco, Wash. Only. **\$147.50**

THE M. R. COMPANY  
 P. O. Box 1220-B Beverly Hills, Calif.

Selenium & Silicon Rectifiers manufactured by TECHNICAL APPARATUS BUILDERS Distributed by "TAB"

SEMI-CONDUCTOR RECTIFIERS to Your Specs Any Current. Quick Delivered! Write for Quantity Prices. \*FULL WAVE BRIDGE & P.C.T. \*DATED & ONE YEAR GTD.

SELENIUM REPLACEMENTS table with columns for Halfwave, VAC, AMP, S, Center Tap, VAC, AMP, S.

SEMI-CONDUCTOR RECTIFIERS OPERATING TO 190°C table with columns for MAX, VAC, AMP, S, VAC, AMP, S.

SEMI-CONDUCTOR RECTIFIERS OPERATING TO 190°C table with columns for MAX, VAC, AMP, S, VAC, AMP, S.

NEW SILICON "SILTAB" JUNCTION RECTIFIERS OPERATING TO 190°C table with columns for MAX, VAC, AMP, S, VAC, AMP, S.

"TABTRAN" Rectifier Xfms. Sec'd Volts (DUAL) 0-3-15-18 & 0-3-15-18 Series Sec'ds 0-3-6-12-15-18-21-24-27-30-33-36 Volts

"TABTRAN" Rectifier Chokes. CR6001/1 1 Amp/0.1 HY/1.4 Ohm \$3.50

New Hi-Capacity Condensers. CE156M 6000MFD 15V \$2.00

New 5-Way Binding "TEK-AP" POSTS. Similar to Superior DP30, takes plus type lugs

"TEK-AP" TABPAKS! High Current Power Supplies. One Year Guarantee

BATTERY CHARGER STACKS + REPLACEMENT OR CONVERSION. Type CR20V, CR30V, CR40V, CR50V, CR60V, CR70V, CR80V, CR90V, CR100V

New Variable Voltage X-frms. SUPERIOR-GR-STACO. 0-135V/3A \$7.23

450 MA CHOKES. W.E. Mfg for U.S.N. Rated 4Hy 450mA/3KV/27 ohm

TP502/5500VCT @ 60ma/WST/USN \$39. TP527/77VCT @ 200ma/5V/3A, 3.3VCT @ 5A

TPF53/540VCT @ 30ma/6.3V/2A \$3.54. TPF54/150V @ 30ma/6.3V/1A \$1.40

TPF55/900VCT @ 35ma/2x2.5V @ 2A \$3.20. TPF57/2500 @ 10ma/2x2.5V @ 2A \$4.10

TPF58/580 5100 5000VCT @ 40ma/59. TPF59/2100 @ 10ma/2x2.5V @ 2A \$4.54

TPF60/150V @ 30ma/6.3V/1A \$1.40. TPF61/150V @ 30ma/6.3V/1A \$1.40

TPF62/150V @ 30ma/6.3V/1A \$1.40. TPF63/150V @ 30ma/6.3V/1A \$1.40

TPF64/150V @ 30ma/6.3V/1A \$1.40. TPF65/150V @ 30ma/6.3V/1A \$1.40

TPF66/150V @ 30ma/6.3V/1A \$1.40. TPF67/150V @ 30ma/6.3V/1A \$1.40

TPF68/150V @ 30ma/6.3V/1A \$1.40. TPF69/150V @ 30ma/6.3V/1A \$1.40

TPF70/150V @ 30ma/6.3V/1A \$1.40. TPF71/150V @ 30ma/6.3V/1A \$1.40

TPF72/150V @ 30ma/6.3V/1A \$1.40. TPF73/150V @ 30ma/6.3V/1A \$1.40

TPF74/150V @ 30ma/6.3V/1A \$1.40. TPF75/150V @ 30ma/6.3V/1A \$1.40

TPF76/150V @ 30ma/6.3V/1A \$1.40. TPF77/150V @ 30ma/6.3V/1A \$1.40

TPF78/150V @ 30ma/6.3V/1A \$1.40. TPF79/150V @ 30ma/6.3V/1A \$1.40

TPF80/150V @ 30ma/6.3V/1A \$1.40. TPF81/150V @ 30ma/6.3V/1A \$1.40

TPF82/150V @ 30ma/6.3V/1A \$1.40. TPF83/150V @ 30ma/6.3V/1A \$1.40

TPF84/150V @ 30ma/6.3V/1A \$1.40. TPF85/150V @ 30ma/6.3V/1A \$1.40

TPF86/150V @ 30ma/6.3V/1A \$1.40. TPF87/150V @ 30ma/6.3V/1A \$1.40

TPF88/150V @ 30ma/6.3V/1A \$1.40. TPF89/150V @ 30ma/6.3V/1A \$1.40

TPF90/150V @ 30ma/6.3V/1A \$1.40. TPF91/150V @ 30ma/6.3V/1A \$1.40

TPF92/150V @ 30ma/6.3V/1A \$1.40. TPF93/150V @ 30ma/6.3V/1A \$1.40

"TAB" THAT'S A BUY. Laboratory Insts—Write for Catalog! WE BUY! SELL & TRADE!

PRECISION POTENTIOMETERS. HELIPOT, MULTIPOT Ten Turn 0.5% ohms 100, 1000, 5000, 20K

STEVENS ARNOLD PRECISION DC-AC CHOPPER TYPE CH365. SPDT/COIL 26VDC/00 IMP

WRITE FOR HI-FI CATALOG. Guaranteed Phone Replacement No Dies Registered a Year Ago by the After

PULSE TRANSFORMERS. Pulse Blocking Osc. windings 1:1 ratio, 100V

WRITE FOR INDUSTRIAL CATALOG. UTAH 352-7174/9440 \$2.66 for 510 20 to \$25

WRITE FOR COMPLETE TUBE LIST. TUBES "TAB" TESTED INSPECTED GUARANTEED!!!

WRITE FOR COMPLETE TUBE LIST. TUBES "TAB" TESTED INSPECTED GUARANTEED!!!

WRITE FOR COMPLETE TUBE LIST. TUBES "TAB" TESTED INSPECTED GUARANTEED!!!

WRITE FOR COMPLETE TUBE LIST. TUBES "TAB" TESTED INSPECTED GUARANTEED!!!

WRITE FOR COMPLETE TUBE LIST. TUBES "TAB" TESTED INSPECTED GUARANTEED!!!

WRITE FOR COMPLETE TUBE LIST. TUBES "TAB" TESTED INSPECTED GUARANTEED!!!

WRITE FOR COMPLETE TUBE LIST. TUBES "TAB" TESTED INSPECTED GUARANTEED!!!

WRITE FOR COMPLETE TUBE LIST. TUBES "TAB" TESTED INSPECTED GUARANTEED!!!

WRITE FOR COMPLETE TUBE LIST. TUBES "TAB" TESTED INSPECTED GUARANTEED!!!

WRITE FOR COMPLETE TUBE LIST. TUBES "TAB" TESTED INSPECTED GUARANTEED!!!

WRITE FOR COMPLETE TUBE LIST. TUBES "TAB" TESTED INSPECTED GUARANTEED!!!

WRITE FOR COMPLETE TUBE LIST. TUBES "TAB" TESTED INSPECTED GUARANTEED!!!

WRITE FOR COMPLETE TUBE LIST. TUBES "TAB" TESTED INSPECTED GUARANTEED!!!

WRITE FOR COMPLETE TUBE LIST. TUBES "TAB" TESTED INSPECTED GUARANTEED!!!

WRITE FOR COMPLETE TUBE LIST. TUBES "TAB" TESTED INSPECTED GUARANTEED!!!

WRITE FOR COMPLETE TUBE LIST. TUBES "TAB" TESTED INSPECTED GUARANTEED!!!

WRITE FOR COMPLETE TUBE LIST. TUBES "TAB" TESTED INSPECTED GUARANTEED!!!

THAT'S "TAB" THAT'S A BUY. Dept. 12E7 111 Liberty St., New York 6, N. Y., U. S. A. PH. RECTOR 2-6245 CABLE: "TABPARTS"

# INDEX TO ADVERTISERS

A C Electronics Div.	199	Cannon Electric Co.	100
Ace Electronics Associates, Inc.	252	Celen-Constantine Engineering Laboratories Co.	365
Aeme Wire Co.	320	Centralab, A Div. of Globe-Union Inc.	64A 64B
Acton Laboratories, Inc.	337	Century Electronics & Instruments Inc.	228
Adams & Westlake Co.	112	Chicago Aerial Industries, Inc.	315
Adel Precision Products	312	Chicago Standard Transformer Corp.	266
Aeronautical Communications	68	Chicago Telephone Supply Corp.	33
Airpax Products Co.	54	Christie Electric Corp.	338
Allegheny Ludlum Steel Corp.	34	Cinch Mfg. Corp.	175
Allen-Bradley Co.	265	Clare & Co., C. P.	67
Allies Products Corp.	293	Cleveland Container Co.	272
American Electronics, Inc.	238	Clevite Transistor Products	187
American Electronic Laboratories	364	Cohn Corp., Sigmund	268
American Lava Corporation	197	Coil Winding Equipment Co.	334
American Rondo	303	Communications Company	363
American Time Products Inc.	50	Computer-Measurements Corp.	206
Amperex Electronic Corp.	205	Connecticut Hard Rubber Co.	106
Amperite Co., Inc.	188	Consolidated Electrodynamics	195
Ampex Corp.	193	Cornell-Dubilier Electric Corp.	249
Amphenol Electronics Corp.	184	Corning Glass Works	62
AMP Incorporated	47	Cosmic Condenser Co.	324
Anaconda Wire & Cable Co.	253	Cossor (Canada) Ltd.	300
Andrew Corporation	211	Coto-Coil Co., Inc.	364
Anso, a Div. of General Aniline & Film Corp.	48	Cross Co., H.	294
Arnold Engineering Co.	13	Crucible Steel Company of America	83
Assembly Products, Inc.	98		
		Dale Products, Inc.	93
Baker & Co., Inc.	63	Dano Electric Co.	338
Ballantine Laboratories, Inc.	230	Daven Company	3rd Cover
Baltic Metal Products Co.	310	Daystrom Instrument Div. of Daystrom Inc.	244
Barry Controls, Inc.	21	Daytona Beach, Industrial Dept., Chamber of Commerce	285
Bausch & Lomb Optical Co.	232	Del Electronics Corp.	254
Beede Electrical Instrument Co., Inc.	240	DeMornay-Bonardi	324
Bell Telephone Laboratories	209	Dialight Corporation	295
Bendix Aviation Corp.		Digitac, Inc.	189
Red Bank Div.	120, 231	Dow Chemical Company	40
Bentley Harris Mfg. Co.	32	Dow Corning Corp.	81
Berkeley Div., Beckman Instruments Inc.	66	Drakenfeld & Co., Inc., B. F.	312
Bird Electronic Corp.	268	Driver-Harris Company	15
Boonton Radio Corp.	76	Dumont Laboratories Inc., Allen B.	35, 107
Borg Corp., George W.	290, 291	duPont de Nemours & Co. (Inc.) E. I. Film Dept.	75
Brand & Co., William	39	Pigments Department	247
Brew and Co., Richard D.	293	Durant Manufacturing Co.	330
Buckbee Mears Co.	276		
Burndy Corporation	70	Eagle Signal Corp.	262
Burnell & Co., Inc.	9	Eastern Industries, Inc.	77
Burroughs Corp.	307, 309, 311	Eisler Engineering Co., Inc.	296
Bussmann Mfg. Co.	72	Eitel-McCullough, Inc.	71, 243
		Electrical Industries	103
Caledonia Electronics and Transformer Corp.	276		
Cambridge Thermionic Corp.	94		



## ACRO-MATCH ANTENNAS

### VERTICAL HALF-WAVE ANTENNAS FOR FIXED STATIONS

The performance and reliability of these antennas has been proven by eight years of commercial production. Hundreds used by U.S. Navy in both bands.

#### FEATURES:

- Very easy and accurate matching results in exceptionally low VSWR.

- Entire antenna at ground potential for lower noise and lightning protection.

- 83-IR and 83-IAP fittings furnished for 52 OHM RG 8/U coaxial cable.

RIGHT-Model 399 P  
118-174 mc. \$25.00  
F.O.B. Miami, Fla.

LEFT-Model 396 P 25-  
54 mc. \$75.00 F.O.B.  
Miami, Fla.

**COMMUNICATIONS COMPANY, INC**  
CORAL GABLES, MIAMI 34, FLA.

Write for complete information on two-way radio equipment and accessories.

CIRCLE 296 READERS SERVICE CARD

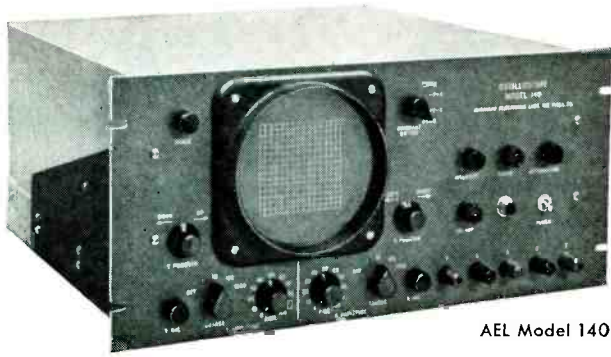

AEL Model 140

## Display Oscilloscope

A display unit for use as a dynamic indicator with ANALOG COMPUTERS, CURVE and FUNCTION GENERATORS, etc. The "140" is designed with very low values of hum, noise and drift specifically to enable quantitative measurements. No internal sweeps are provided.

- Built-in QUADRANT SWITCHING
- FLAT FACED TUBE 5ADP ( )
- Frequency Compensated Input Attenuators
- Z-Axis blanking
- IDENTICAL horizontal and verticle amplifiers
- 20 mv/inch, dc to 50 kc. (max.)
- Standard Rack Mounting
- ENGINEERED control panel

POWER 105-125/210-250, 50/60 cps

PRICE \$425.00

**AMERICAN ELECTRONIC LABORATORIES, Inc.**

121 N. 7th Street, Philadelphia 6, Pa. • WALnut 5-8780

**AEL**

CIRCLE 297 READERS SERVICE CARD

## Electrical Coil Windings

For 40 years . . . specializing in all types of coils to customers' specifications. Design or engineering assistance available on request.

# COTO-COIL CO., INC.

SINCE 1917

65 Pavilion Avenue Providence 5, Rhode Island

CIRCLE 298 READERS SERVICE CARD

**PRECISION  
PLASTIC  
CAPACITORS  
AT  
COMPETITIVE  
PRICES!**

### POLYSTYRENE and MYLAR\*

Capacitance From .001 mfd to any value  
Voltage From 50 V.D.C. to 30 KV  
Tolerance Polystyrene From  $\pm 0.1\%$  to  $\pm 5\%$   
Mylar\* From  $\pm 1\%$  to  $\pm 10\%$

### SMALLEST CASE SIZES

### TUBULAR—BATHTUB—RECTANGULAR

Very Good Deliveries \*DuPont T.M.

### PRECISION CAPACITORS, INC.

150 W. Cypress Ave. Burbank, Calif.

Electro Engineering Works, Inc.	297
Electro-Pulse, Inc.	210
Electro-Snap Switch & Mfg. Co.	97
Electro Tee Corporation	251
Electronics	116, 117
Electronic Batteries, Inc.	326
Electronic Engineering Company of California	335
Electronic Instrument Co., Inc. (EICO)	320
Electronics Division, Elgin National Watch Co.	269
Electronics International Co.	236
Epsco Incorporated	319
Eraser Co., Inc.	246
Erie Electronics Division, Erie Resistor Corp.	270, 271
Esterline-Angus Co., Inc.	304

Fansteel Metallurgical Corp.	260, 261
Fenwal Electronics, Inc.	331
Ferroxcube Corp. of America	278
Filtors, Inc.	101
Fluorulon Laboratories	327
Ford Radio & Mica Corp.	336
Franklin Electronics, Inc.	198
Freed Transformer Co., Inc.	368

G-M Laboratories, Inc.	298
Gamewell Company	208
Garrett Corporation	114
General Electric Co. Magnetic Materials Section	234
Semiconductor Products Dept.	257
Tube Dept.	105
General Radio Co.	17
Good-All Electric Mfg. Co.	191
Grant Pulley & Hardware Corp.	181
Graphic Systems	328
Grayhill, Inc.	310
Gries Reproducer Corp.	321
Gudebrod Bros. Silk Co., Inc.	299

Hamilton Mfg. Co.	337
Handy & Harmon	102
Hathaway Instrument Div. of Hamilton Watch Company	88
Haydon Mfg. Co., Inc.	186
Heath Company	279
Helland, a Div. of Minneapolis-Honeywell	60, 61
Hellipot Corp., Beckman Div.	200, 201
Hewlett-Packard Company	122, 123
Heyman Mfg. Co.	299
Homelite a Div. of Textron Inc.	222
Hopkins Engineering Co.	297
Horman Associates, Inc.	339
Hudson Cushion Corporation	366
Hughes Products, a Div. of Hughes Aircraft Co.	73, 80
Humphrey, Inc.	264



Hunt Company, Phillip A. . . . . 256  
 Hycor Div. of International Resistance  
 Co. . . . . 329

Indiana Steel Products Co. . . . . 52  
 Indium Corp. of America . . . . . 304  
 Industrial Instruments, Inc. . . . . 324  
 Industrial Timer Corporation . . . . . 96  
 Institute of Radio Engineers . . . . . 317  
 Insuline Corp. of America . . . . . 240

Jeffers Electronics Div. of Speer Carbon  
 Co. . . . . 323  
 Jennings Radio Mfg. Corp. . . . . 226  
 Johnson Company, E. F. . . . . 196  
 Jones Div., Howard B. Cinch Mfg. Co. . . . . 333  
 Jones Electronics Co., Inc., M. C. . . . . 287

Kahle Engineering Co. . . . . 3  
 Kato Engineering Co. . . . . 337  
 Kay Electric Co. . . . . 27  
 Kepco Laboratories, Inc. . . . . 179  
 Kester Solder Co. . . . . 215  
 Kintel (Kay Lab) . . . . . 203

Lambda Electronics Corp. . . . . 109  
 Lampkin Laboratories, Inc. . . . . 340  
 Lapp Insulator Co., Inc. . . . . 192  
 Leach Corporation . . . . . 220  
 Leland, Inc., G. H. . . . . 274  
 Lepel High Frequency Laboratories, Inc. . . . . 328  
 Librascope, a Subsidiary of General  
 Precision Equipment . . . . . 79  
 Linde Company, Div. of Union Carbide  
 Corp. . . . . 331

M B Manufacturing Company, A Divi-  
 sion of Textron Inc. . . . . 283  
 MacDonald, Inc., Samuel . . . . . 339  
 Magnatran, Inc. . . . . 314  
 Magnetics, Inc. . . . . 84, 85, 185  
 Mallory and Co., Inc., P. R. . . . . 124, 177  
 Mansol Ceramics Co. . . . . 331  
 Marconi Instruments Ltd. . . . . 5  
 Marconi Wireless Telegraph Co., Ltd. . . . . 58  
 McCoy Electronics Company . . . . . 367  
 Measurements, a McGraw-Edison Divi-  
 sion . . . . . 335  
 Metals & Controls Corp., General Plate  
 Div. . . . . 44  
 Millen Mfg. Co., Inc., James . . . . . 308  
 Minnesota Mining and Manufacturing . . . . . 36  
 Mullard Overseas Ltd. . . . . 255



**GALILEO:**



... man with optik tube

The 1600's shivered when Galileo with his 'Optik Tube' peered farther into space than had any man before him. He shook his world with unbelievable news of millions of stars, of the strange surface on that beautiful, baleful satellite, the Moon. Who did not shiver again when we woke up to the news of a man-made moon traveling 18000 mph at nearly 600 miles altitude?

But ours understandably became a shiver of pleasure at the thought that somewhere in the first space tube to the Moon, Mars, and Venus will be electronic components from Schweber's. Hats off and sleeves up to the new challenges of the Interplanetary Age.

CHECK  SCHWEBER FIRST... HE IS A SPECIALIST

60 HERRICKS ROAD • MINEOLA, L. I., N. Y. • PIONEER 6-6520

CIRCLE 300 READERS SERVICE CARD

**Celco**  
 TRANSISTORIZED **YOKES**

7/8" ★ 1" ★ 1 1/8" ★ 2" ★ 2 1/2" CRT NECK DIA.

for **MILITARY** and **COMMERCIAL PRECISION DISPLAYS**

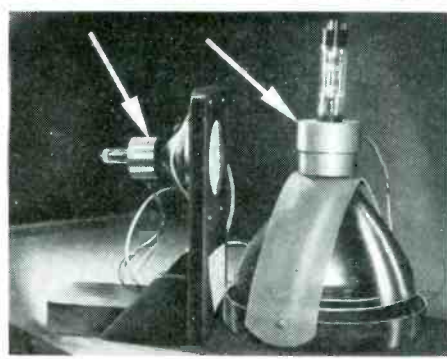

- HIGH RESOLUTION
- FAST RECOVERY
- HIGH SENSITIVITY
- LOW LI<sup>2</sup>
- CONTROLLED MAGNETIC FIELDS

Write for CELCO DEFLECTION YOKE Catalogue & Design Sheets or for immediate engineering assistance Call your nearest CELCO Plant:

Mahwah, N. J.      Miami, Fla.      Cucamonga, Calif.  
 Davis 7-1123      Plaza 1-9083      Yukon 2-2688

**Celco** *Constantine Engineering Laboratories Co.*

# A MUST... GELATIN DUST MATS

FOR: AIR LOCKS  
TRANSISTOR AREAS  
DUST FREE AREAS

GELATIN DUST MATS remove and hold dust and dirt from soles of shoes.

## They are:

Non-skid-nonstatic, which means they are safe to walk on.

Fire proof

Easy to clean. (A kerosene cloth will restore and clean your mat in a few minutes)

Durable and have tack.

Standard size: \$80.00  
5' long, 3' wide, 1" thick.

Other sizes made to order and priced proportionately.

Sample will be mailed on request

## HUDSON CUSHION CORPORATION

70-25 Cypress Hills Street  
Ridgewood 27, N. Y.  
Phone: EVERgreen 6-3593

CIRCLE 303 READERS SERVICE CARD

## FOR READY ACCESS TO ACCURATE FREQUENCY CALIBRATION

## FULLY TRANSISTORIZED SELF POWERED FREQUENCY STANDARD

10 KC, 100 KC,  
1 MC. Frequency  
Stability,  
± .002% to  
+50° C.



**\$12575**

- Completely transistorized
- Fundamental outputs at 1 MC, 100 KC and 10 KC
- High accuracy to +70° C
- Self powered by batteries
- Very low power drain
- Extremely portable
- Harmonic content usable beyond 200 MC
- Built-in modulation
- Printed circuit construction
- Multipurpose frame-handle

**TRANSITRON INC.**  
Division of Van Norman Industries, Inc.  
186 Granite Street  
Manchester, New Hampshire

CIRCLE 304 READERS SERVICE CARD

N J E Corporation.....	225
National Lead Company.....	86
Natvar Corporation.....	82
Nems-Clarke, Inc.....	314
New Departure Div. of General Motors.....	221
New Hampshire Ball Bearings, Inc.....	202
New Hermes Engraving Machine Corp.....	273, 301
Niemand Bros., Inc.....	292
North Electric Co.....	224
Northeastern Engineering.....	190

Oak Mfg. Co.....	74
Ohmite Mfg. Co.....	59
Oregon Electronics.....	275

Pace Electrical Instruments Co., Inc.....	285
Panoramic Radio Products, Inc.....	322
Perkin Engineering Corp.....	25
Phalo Plastics Corp.....	55
Phelps-Dodge Copper Products Corp. Inca Mfg. Div.....	42, 43
Philbrick Researches, Inc., George A.....	78
Phileo Corporation.....	29
Phillips Control Corp.....	321
Phillips & Hiss Company, Inc.....	340
Plastoid Corp.....	281
Polarad Electronics Corporation.....	48A, 48B
Potter & Brunfield, Inc.....	218, 219
Potter Instrument Co.....	258
Precision Capacitors, Inc.....	364
Pulse Engineering.....	336
Pyle-National Co.....	51

RBM Division Essex Wire Corp.....	245
RCA Electron Tube Division.....	4th Cover
Radiation Inc.....	194
Radio Cores, Inc.....	325
Radio Engineering Laboratories, Inc.....	41
Radio Engineering Products.....	302
Radio Materials Corp.....	115
Radiometer.....	340
Radio Receptor Co., Inc.....	233
Ramo-Wooldridge Corp.....	305
Rawson Electrical Instrument Co.....	327
Raytheon Mfg. Company.....	18, 19, 227
Relay Sales Inc.....	237
Rex Rheostat Co.....	339
Robinson Aviation, Inc.....	49

Sanborn Company.....	95
Schweber Electronics.....	365
Sel-Rex Corporation.....	286
Shalleross Mfg. Co.....	277
Shielding, Inc.....	223
Sierra Electronic Corp.....	121

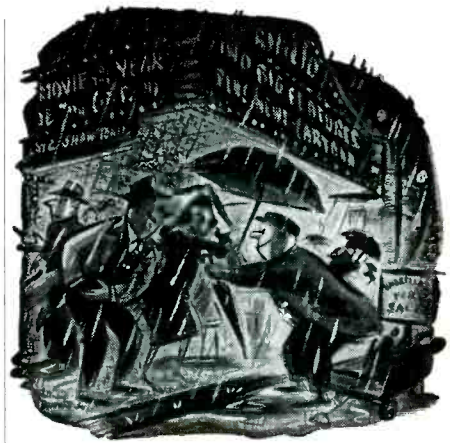

## All business is specialized

...and nothing specializes  
on your business like your  
business paper

This profit-wise peddler looks for the wettest crowds. His business is specialized. Like yours.

And like your business, this business paper of yours specializes, too. It packs into one place the current facts you want. It scouts out, sorts out, reports and interprets the specific news and information you need to keep posted and keep ahead in your field. Cover to cover, editorials and ads, it concentrates on bringing you specialized help you can't get anywhere else. Read it thoroughly... and put it to work.

This business paper in your hand has a plus for you, because it's a member of the Associated Business Publications. It's a paid circulation paper that must earn its readership by its quality... And it's one of a leadership group of business papers that work together to add new values, new usefulness, new ways to make the time you give to your business paper still more profitable time.

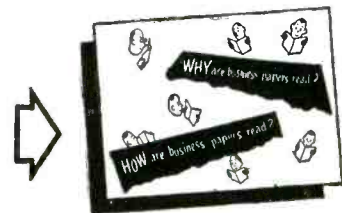

A copy of this quick-reading, 8-page booklet is yours for the asking. It contains many facts on the benefits derived from your business paper and tips on how to read more profitably. Write for the "WHY and HOW booklet." Room 2710.

**McGraw-Hill Publishing Company**  
330 W. 42nd St., New York 36, N. Y.

One of a series of ads prepared by  
THE ASSOCIATED BUSINESS PUBLICATIONS

Simpson Electric Co.	285
Sola Electric Co.	46
Somers Brass Company, Inc.	335
Sorensen & Co., Inc.	4
South Chester Corporation	108
Southern Electronics Corp.	53
Spellman Television Co., Inc.	288
Sperry Gyroscope Co.	87, 217
Sprague Electric Co.	11
Stackpole Carbon Co.	37
Stevens Arnold, Inc.	286
Stoddart Aircraft Radio Co., Inc.	204
Stromberg-Carlson Company	113, 328
Superior Electric Company	23
Superior Tube Co.	92
Switchcraft, Inc.	298
Sylvania Electric Products, Inc.	30, 213
Syntronic Instruments, Inc.	305

Tape Cable Corporation	96A, 96B
Taylor Fibre Co.	38
Technitrol Engineering Co.	294
Tektronix, Inc.	31
Telechrome, Inc.	99
Telrex Laboratories	313
Tensolite Insulated Wire Co.	242
Texas Instruments Incorporated	183
Thermal American Fused Quartz Co., Inc.	338
Transco Products, Inc.	212
Transformers, Incorporated	65
Transitron Electronic Corp.	45
Transitron, Inc.	288, 366
Transradio Ltd.	334
Transval Engineering Corp.	296
Trio Laboratories, Inc.	313
Triplett Electrical Instrument Co.	259
Tung-Sol Electric, Inc.	229

UAC Electronics a Div. of Universal Transistor Products Corp.	280
Ucinite Co.	90
Union Switch & Signal Div. of Westinghouse Air Brake Company	89
United-Carr Fastener Corp.	91
United Transformer Co.	2nd Cover

Van Keuren Co., The	334
Varian Associates	241
Veeder-Root, Inc.	28
Vibration Research Laboratories, Inc.	104
Vulcan Electric Co.	246

Waldes Kohinoor, Inc.	207
Waltham Precision Instrument Co.	282
Waters Mfg., Inc.	284
Welwyn International, Inc.	326

# McCoy quartz crystals

meet  
**5**  
important  
requirements

## SIZE

... Less than 1/2" wide; please note dimensions below.

## WEIGHT

... One twenty-fifth (1/25) of an ounce.

## VIBRATION

... Withstands from 10 to 2000 c.p.s.

## SHOCK

... Withstands from 0 to 30 g.

## STABILITY

... Frequency stabilities of ±.0025% over -55° C to ±90° C possible.

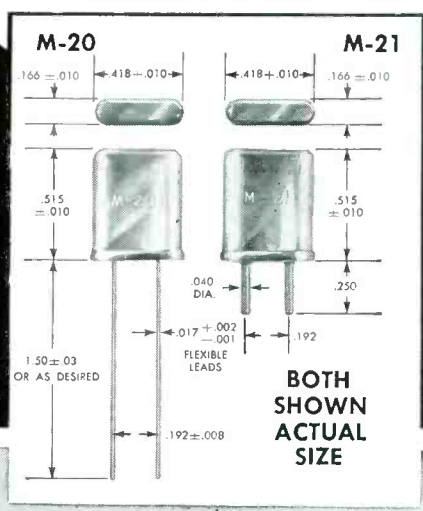

McCoy McMite lightweight quartz crystals extend the limits of electronic design. These little, hermetically sealed units are built rugged to pack regular size performance into minimum space ... with no sacrifice of stability or dependability! Produced in frequencies from 3 mc to 125 mc to meet government specifications or made to your own specifications.

FREE ILLUSTRATED CATALOG.  
Send for your copy today.

# McCoy

ELECTRONICS COMPANY  
MT. HOLLY SPRINGS, PENNA.  
DEPT. 5-12  
PHONE 376-377

# FREED

**MIL-T-27A POWER,  
FILAMENT, PULSE  
& AUDIO TRANSFORMERS**

**FOR IMMEDIATE  
DELIVERY FROM STOCK**

## POWER TRANSFORMERS-STANDARD

All primaries 105/115/125 v., 60 c.p.s.

Cat. No.	Hi Volt Sec.	ct	DC Volts	DC Amps	Filament #1		Filament #2		MIL Case Size
					Volt	Amp.	Volt	Amp.	
MGP1	400/200	✓	185	.070	6.3/5	2	6.3	3	HA
MGP2	650	✓	260	.070	6.3/5	2	6.3	4	JB
MGP3	650	✓	245	.150	6.3	5	5.0	3	KB
MGP4	800	✓	318	.175	5.0	3	6.3	8	LB
MGP5	900	✓	345	.250	5.0	3	6.3	8	MB
MGP6	700	✓	255	.250					KB
MGP7	1100	✓	419	.250					LB
MGP8	1600	✓	640	.250					NB

## FILAMENT TRANSFORMERS-STANDARD

All primaries 105/115/125 v., 60 c.p.s.

Cat. No.	Secondary		Test VRMS	MIL Case
	Volt	Amp		
MGF1	2.5	3.0	2,500	EB
MGF2	2.5	10.0	2,500	GB
MGF3	5.0	3.0	2,500	FB
MGF4	5.0	10.0	2,500	HB
MGF5	6.3	2.0	2,500	FB
MGF6	6.3	5.0	2,500	GB
MGF7	6.3	10.0	2,500	JB
MGF8	6.3	20.0	2,500	KB
MGF9	2.5	10.0	10,000	JB
MGF10	5.0	10.0	10,000	KB

## PULSE TRANSFORMERS

Cat. No.	Block % Osc.	Int. Coupl'g	Low. Pow. Out.	Pulse Voltage KiloVolts	Pulse Duration Microseconds	Duty Rate	No. of Wdg.	Test Volt. KV/VRMS	Char. Imp. Ohms
MPT1	✓	✓	✓	0.25/0.25/0.25	0.2-1.0	0.004	3	0.7	250
MPT2	✓	✓	✓	0.25/0.25	0.2-1.0	0.004	2	0.7	250
MPT3	✓	✓	✓	0.5/0.5/0.5	0.2-1.5	0.002	3	1.0	250
MPT4	✓	✓	✓	0.5/0.5	0.2-1.5	0.002	2	1.0	250
MPT5	✓	✓	✓	0.5/0.5/0.5	0.5-2.0	0.002	3	1.0	500
MPT6	✓	✓	✓	0.5/0.5	0.5-2.0	0.002	2	1.0	500
MPT7	✓	✓	✓	0.7/0.7/0.7	0.5-1.5	0.002	3	1.5	200
MPT8	✓	✓	✓	0.7/0.7	0.5-1.5	0.002	2	1.5	200
MPT9	✓	✓	✓	1.0/1.0/1.0	0.7-3.5	0.002	3	2.0	200
MPT10	✓	✓	✓	1.0/1.0	0.7-3.5	0.002	2	2.0	200
MPT11	✓	✓	✓	1.0/1.0/1.0	1.0-5.0	0.002	3	2.0	500
MPT12	✓	✓	✓	0.15/0.15/0.3/0.3	0.2-1.0	0.004	4	0.7	700

## AUDIO TRANSFORMERS

Frequ. resp. 300 to 10000 cps ± 2 DB. All Case Sizes AJ

Catalog No.	Application	Impedance			DC Current		Max. Level DBM
		Prim. Ohms	Sec. Ohms	CL	Prim. P. Sizing Unit. MVA	Unit. MA	
MGA1	Single or P.P. Plates to Single or P.P. Grids	10K	90K Split	✓	10	10	15
MGA2	Line to Voice Coil	600 Split	4, 8, 16	✓	0	0	33
MGA3	Line to Single or P.P. Grids	600 Split	135K	✓	0	0	15
MGA4	Line to Line	600 Split	600	✓	0	0	15
MGA5	Single Plate to Line	7.6K 4.8T 7.9K	600 Split	✓	40	40	33
MGA6	Single Plate to Voice Coil	4.8T	4, 8, 16	✓	40	40	33
MGA7	Single or P.P. Plates to Line	15K	600 Split	✓	10	10	33
MGA8	P.P. Plates to Line	24K	600 Split	✓	10	1	30
MGA9	P.P. Plates to Line	60K	600 Split	✓	10	1	27

Send for further information on these units, or special designs. Also ask for complete laboratory test instrument catalog.

**FREED  
TRANSFORMER CO., INC.**

1722 Weirfield Street  
Brooklyn (Ridgewood) 27, New York

CIRCLE 306 READERS SERVICE CARD

Wenco Manufacturing Co. ....	327	Sanders Associates Inc. ....	348
Western Devices, Inc. ....	295	Scientists, Engineers & Executives. ....	350
Westinghouse Electric Corp. ....	56, 57, 118, 119, 239, 300	Sprague Electric Co. ....	348
Weston Electrical Instrument Corp., a Subsidiary of Daystrom, Inc. ....	69	Stavid Engineers ....	346
Wheelock Signals, Inc. ....	301	Sylvania Electric Products Inc. ....	348
White Dental Mfg. Co., S. S. ....	64	Texas Instruments Inc. ....	347
Williams & Co., C. K. ....	306	Tung-Sol Electronics Inc. ....	350

Zell Products Corp. .... 302, 303

## SEARCHLIGHT SECTION ADVERTISERS

Alltronics-Howard Co. ....	357
Alvaradio Industries Inc. ....	356
Arrow Sales Inc. ....	360

Professional Services. .... 339

Barry Electronics Inc. ....	354, 358
Belvision Inc. ....	357
Blan ....	358

## CLASSIFIED ADVERTISING F. J. Eberle, Business Mgr.

EMPLOYMENT OPPORTUNITIES. 341-351

EDUCATIONAL ..... 354

BUSINESS OPPORTUNITIES ..... 354

EQUIPMENT  
(Used or Surplus New)  
For Sale ..... 352-362

WANTED ..... 354

## EMPLOYMENT OPPORTUNITIES ADVERTISERS

Aircraft Radio Corp. .... 351  
Automatic Voting Machine Corp. .... 350

Bendix Aviation Corp  
York Division ..... 351  
Boonton Radio Corp. .... 350

Chance Vought Aircraft Inc. .... 351  
Cooper, J. J. .... 350

Fidelity Personnel Service. .... 350

Goodyear Aircraft Corp  
Akron, Ohio ..... 345  
Litchfield Park, Arizona. .... 349

International Business Machines Corp. .... 341

Johns Hopkins University, ORO ..... 346

Kollsman Instrument Corp. .... 350

Melpar Inc. .... 344  
Monarch Personnel ..... 350

Motorola Inc.  
Chicago, Illinois ..... 349  
Phoenix, Arizona ..... 344

Raytheon Manufacturing Co. .... 342, 343

Electronic Research Laboratories. .... 360  
Legri S Co. .... 360  
Liberty Electronics Inc. .... 360

M. R. Co., The. .... 361  
Magna Electronics Corp. .... 361  
Metro Electronics ..... 354  
Monmouth Radio Labs. .... 358  
Montgomery Equipment Co. .... 361

Pacific International University. .... 354  
Page Electronics ..... 361

Radalab Inc. .... 353  
Radio Research Instrument Co. .... 357  
Raway Bearing Co. .... 357

"TAB" ..... 362  
Tallen Co., Inc. .... 356  
Transitube Inc. .... 356

Universal Relay Corp  
(formerly Universal General Corp).... 360

V & H Radio & Electronics. .... 357

Western Engineers ..... 359

This index is published as a service. Every care is taken to make it accurate, but ELECTRONICS assumes no responsibilities for errors or omissions.

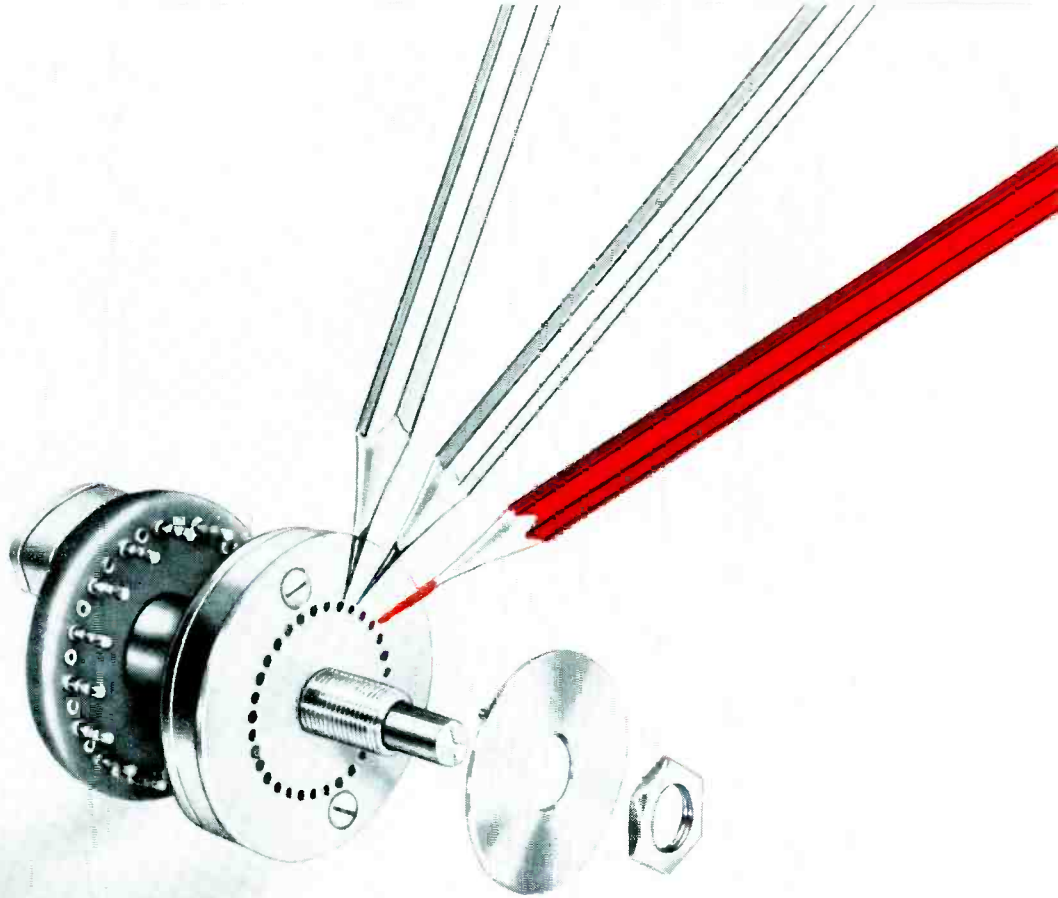

# Stop it

## ... where you want it!

### Daven's New Rotary Switch with Adjustable Stop

For flexibility in all types of circuit experimentation, laboratory work, breadboard setups, and in circuitry where the exact number of switch positions might be changed at a later date, the new DAVEN Rotary Switch with an Adjustable Stop is ideal. This unit, as a single pole switch, can have a maximum of either 24 shorting positions with  $15^\circ$  spacing or 32 shorting positions with  $11\frac{1}{4}^\circ$  spacing. One, two, three, and four pole units are available in this design.

In common with all other DAVEN Rotary Switches, the Adjustable Stop Switch features sturdy, dependable construction; silver alloy contacts and slip rings; tamper-proof,

KNEE ACTION\* silver alloy rotor blades; high grade, accurately machined dielectric; and gold flashed turret-type terminals for ease of soldering.

\*Patented

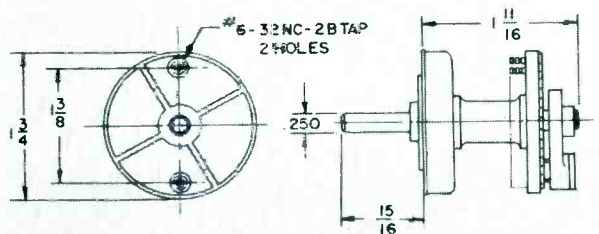

Write for complete information.

THE **DAVEN** CO.

LIVINGSTON, NEW JERSEY

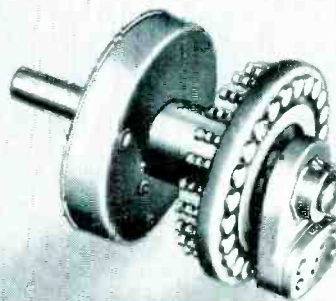

TODAY, MORE THAN EVER, THE DAVEN  STANDS FOR DEPENDABILITY!

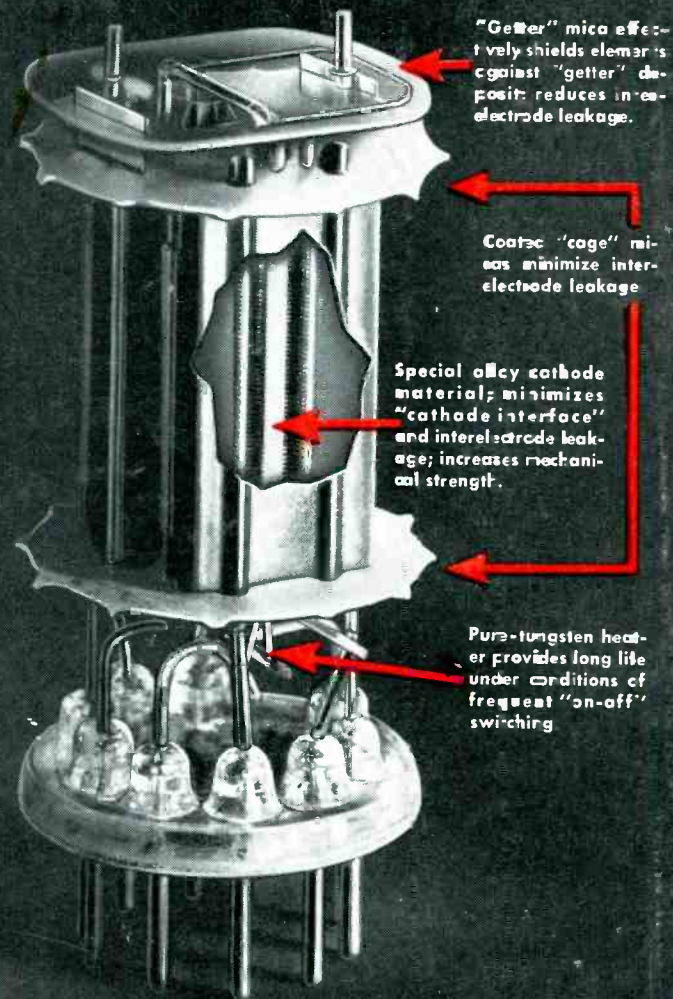
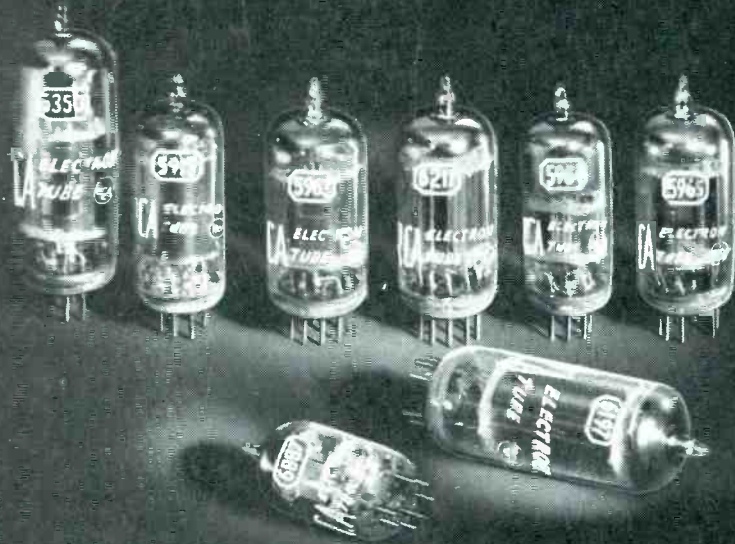

"Getter" mica effectively shields elements against "getter" deposit; reduces inter-electrode leakage.

Coatco "cage" micas minimize inter-electrode leakage

Special alloy cathode material; minimizes "cathode interface" and inter-electrode leakage; increases mechanical strength.

Pure-tungsten heater provides long life under conditions of frequent "on-off" switching

Why

# RCA TUBES

## are specified for COMPUTER DESIGNS

Long-life reliability ... the result of selected materials, rigid quality controls, and exacting inspection and test procedures... makes RCA tubes the right choice for electron computer designs. *Materials* are selected and processed to assure low gas-evolution and to provide relative freedom from "cathode interface". *Quality Control* extends from purity-control of manufacturing areas, through careful selection and training of personnel, to 100% microscopic inspection of tube structures at more than a half-hundred check points. *Sample Testing* of tubes from each production run makes certain that no tubes are released for shipment until long-life test data are complete for the "lot". Super-Sensitive tests for high resistance shorts, 100-hour survival-rate life tests and 5000-hour life tests on a continuous sampling basis weed out potential early-hour failures and provide a "quality monitor" to assure long-life reliability.

RCA tubes for computers are ideally suited to applications as gated amplifiers, frequency dividers, pulse amplifiers, cathode followers, "on-off" switching. Illustrated above are medium-mu twin triodes: 5963, 5964, 5965, 6211, 6350; pentagrid amplifier: 5915; power pentode: 6197; twin diode: 6887.

**SEND FOR NEW BOOKLET RIT-104A—**  
"Receiving-Type Tubes for Industry and Communications." Includes descriptions and basic data on RCA Computer and other special tube types. Designers of computer equipment are invited to discuss tube requirements with their RCA Field Representative at the nearest RCA Field Office. For your copy, write RCA Commercial Engineering, Section L-19-Q-1, Harrison, New Jersey.



**RADIO CORPORATION OF AMERICA**

® *Electron Tube Division*

*Harrison, N. J.*

**RCA FIELD OFFICES:**

744 Broad Street, Newark 2, N.J.,  
HUMboldt 5-3900

Suite 1181, Merchandise Mart Plaza,  
Chicago 54, Ill., WHitehall 4-2900

6355 E. Washington Boulevard,  
Los Angeles 22, Calif., RAymond 3-8361